



Valley Panther ZD-X  
Service Manual and Instructions





# The Valley Panther ZD-X

## Contents

- 3 – Warranty**
- 6 – Battery Guide**
- 9 – MEI Bill Acceptor**
- 11 – Panther 5-bolt rail system**
- 12 – Programming Basics**
- 13 – Programming Tutorial**
  - **15 – Available Programs**
  - **17 – Time and Day**
  - **18 – Print Report**
  - **19 – League Audits**
  - **20 – League Setup**
  - **21 – Check Battery, Restore Defaults**
  - **22 – Master Settings**
  - **24 – Accounting**
  - **25 – Daily Programming**
  - **27 – Rack Cost and Credit Level**
  - **28 – Time Play and cost**
  - **29 – Time Bonus and cost**
  - **30 – Happy Hour Settings**
  - **33 – Copy Options**
  - **34 – Program Chart**
- 35 – USB Copy/Download and Editing**
- 40 – Wiring Diagram and Schematic**
- 42 – ESD Push Chute Adjustment**
- 45 - Selected Parts list.**



## The Valley Panther ZD-X



### Warranty Details

Valley-Dynamo warrants its new products to be free from defects resulting from faulty manufacture or faulty components under the following terms and conditions:

#### **WARRANTY LENGTH**

**One year** on Valley® Pool Tables

**90 days** on Batteries, Battery Chargers and Replacement Parts

**TOURNAMENT USED** products receive identical coverage with regard to manufacturing defects and faults. As used equipment they may be damaged from shipping or use and are discounted accordingly.

#### **FOR WARRANTY SERVICE**

Valley-Dynamo will, at its sole option, repair, upgrade or replace this product in the event of any defect in materials or workmanship during the warranty period. This shall be Valley-Dynamo's sole obligation, and the customer's sole remedy, for any warranty claim.

Valley-Dynamo will request and you must provide the **complete Model Number & Serial Number of the unit** (not just the last 5 digits), or other proof of purchase such as an invoice or receipt.



**OPERATORS AND END USERS** – While our Tech Support staff is available to assist with diagnosis and troubleshooting of your problem, contact your Distributor for Warranty Service on your equipment.

**DEALERS AND DISTRIBUTORS** – To obtain replacement and an RMA number, contact Valley-Dynamo referencing the Model number and Serial number of the unit and the nature of the problem. Valley-Dynamo will, at its discretion, send replacement parts and/or issue an RMA for the return of failed parts. To avoid billing issues, request an RMA when the failed part is present or readily available. Credit will be issued only upon receipt and inspection of the RMA. Valley-Dynamo may send replacement parts or issue an account credit. **NO REFUNDS.** Valley-Dynamo reserves the right to cancel outstanding RMAs 30 days after issue. Items returned without an RMA will not be inspected or credited and may be refused or returned at Customer Expense.

**REPLACEMENT PARTS COVERAGE** – Valley-Dynamo warrants replacement parts for 90 days from the date of purchase. To obtain a replacement and an RMA number, contact Valley-Dynamo referencing the nature of the problem and provide proof of purchase. Valley-Dynamo will, at its discretion, send replacement parts and/or issue an RMA for the return of failed parts. To avoid billing issues, request an RMA when the failed part is present or readily available. Upon receipt and inspection of the RMA, Valley-Dynamo may send replacement parts or issue an account credit. **NO REFUNDS.** Valley-Dynamo reserves the right to cancel outstanding RMAs 30 days after issue. Items returned without an RMA will not be inspected or credited and may be refused or returned at Customer Expense.

## SCOPE OF COVERAGE

***Specific note regarding batteries*** – *the lead acid batteries in our Bill Acceptor tables must be charged periodically or they will fail prematurely. Proper maintenance is crucial. Please consult this Manual or the Pool School® section at [www.valleydynamoparts.com](http://www.valleydynamoparts.com) for complete details on proper battery care and maintenance*

Note that our warranty is not an unconditional guarantee for the duration. Valley products are made to our exacting standards and known for their durability, but are not indestructible and may require periodic maintenance in order to function properly. The following are not covered by the warranty.



- 1) Shipping or transport damage
- 2) Normal wear and tear
- 3) Damage or deterioration resulting from neglect, misuse, accident, liquid spills, improper installation (*review page 11: do not overtighten cushion rails*), abuse, pets or mishandling
- 4) Incidental or consequential damage (except at Valley-Dynamo's discretion).
- 5) Removal or installation charges.
- 6) Shipping charges except at Valley-Dynamo's discretion.
- 7) Unauthorized modification of the product.
- 8) Use of this product with unapproved parts, conversion kits or accessories.
- 9) Damage from fire, flood, lightning or other acts of nature

### **EXCLUSION OF DAMAGES**

Valley-Dynamo's sole obligation and liability under this warranty is limited to the repair or replacement of a defective product at our option. Valley-Dynamo shall not, in any event, be liable for any incidental or consequential damages resulting from interruption of service, loss of business or revenue, or for liability in tort relating to this product or resulting from its use or possession.

### **LIMITATIONS OF IMPLIED WARRANTIES**

There are no other warranties, expressed or implied, including but not limited to those of merchantability, revenue generation, or fitness for a particular purpose. The duration of implied warranties is limited to the period specified in the Warranty Length section above.

As technology improves, upgrades to Valley DBA table software and hardware may be made available at Valley-Dynamo's discretion for a nominal fee. Purchase or ownership of a Valley table does not entitle the bearer to free upgrades.

### **TO OBTAIN TECHNICAL SUPPORT**

Please check the resources available at [www.valleydynamoparts.com](http://www.valleydynamoparts.com), e-mail [TECHHELP@valley-dynamo.com](mailto:TECHHELP@valley-dynamo.com), or call 972.595.5300.

### **WARRANTY REGISTRATION**

Can be done online at [www.valleydynamoparts.com](http://www.valleydynamoparts.com).





# The Valley Panther ZD-X

## Battery Guide

Valley-Dynamo has upgraded the rechargeable battery system on the Panther ZD-X. The battery is now 12 volts, 18 amps, and a new 3amp charger is added to allow for faster charges. The battery and charging point are relocated to the end of the table, away from the secure area of the cash boxes, and accessed by an enlarged Clean Out Door. If your locations are involved in the battery charging process, this eliminates the need for them to have access to the cash box area while maintaining the battery.

### Battery Voltage Quick Check

Table should be in the Normal Pricing mode.  
 Press and hold down the Start button for 10 seconds.  
 Display will show

- current time
- version of software
- current voltage

To Exit Press and release the Start Button.

**To get a true voltage reading the table charger cannot be plugged in.  
 The Quick Check function will not work on a table currently in Happy Hour.**



**BATTERY QUICK CHECK**  
 Display shows time, software version  
 Battery voltage  
 At 12.84v this table's battery is sufficiently charged



New battery on the floor of the table, charger to the left, Clean Out Access panel wing nut at upper right



### Charging the battery:

Make sure your battery has a full charge prior to placing it into service. Even though your battery is fully charged when it leaves our facility, just sitting in the table on the way to you will allow some discharge from the battery.

Please be sure to FULLY charge a new battery prior to installing it in the table. This process takes at least 6 hours (in conjunction with the Panther 3amp charger) if the battery is not hooked up to the table,

- WE RECOMMEND A 6 HOUR INITIAL CHARGE.
- If the table is in play mode, we recommend a 7-hour initial charge.  
*(figures based on use of the Panther ZD-X 3-amp charger)*

You cannot “top off” your battery if it is a volt or two low. Plugging it in for a quick one-hour charge will not do the job. Your battery performs best with a full charge.

### **Make the time!!**

Not charging your battery completely will eventually damage the battery. Maybe not today, maybe not next week, but a lot sooner than you’d like.

By not charging the battery completely, eventually you will **never** be able to charge it completely no matter how long you leave it plugged in.

Your battery will be damaged if significantly discharged—imagine if running your car down to ¼ tank caused permanent damage to your engine.

A lead-acid battery cannot be overcharged. Don’t worry that you have left it plugged in for too long. **It doesn’t care.**

### **RECHARGE THE TABLE’S BATTERY REGULARLY EVERY TWO WEEKS**

### Low Battery Warning and Battery Protect mode:

When the voltage on your battery drops to 12.3 volts or lower, you will see a “Low Battery – Please Charge” warning on the table’s LCD Display. Have your locations notify you immediately if this warning appears so that you may take action to prevent permanent damage.

At 12 volts, the message changes to “Low Battery – DBA Off.” Your Bill Acceptor



will not function at this point and games can be vended only by using coins.

At 11.8 volts, the display shuts off completely and will not return until the battery is charged, or replaced with a charged battery. Games can only be vended using the manual push chute.

If the battery is allowed to drop below 10.5 volts, it will become damaged and will no longer hold a full charge. Never. Not even if you plug it in for a month. It may even show 12+ volts, but will no longer be capable of generating enough amps to keep your system going for more than a couple days before going dead again.

More often than not, a battery that will “no longer hold a charge” was not the battery’s problem. It was not charged regularly, or sufficiently, or at all.

### **Battery Warranty Reminder**

Your table is covered by a one-year Warranty to be free of defects, but the Warranty coverage on the Battery is limited to 90 days. Proper battery care is *critical* to guarantee a long life for your battery. Not charging the battery completely or regularly is guaranteed to shorten battery life.

Defective batteries almost always happen within the first few months. Battery failures after six months or more into a pool table’s service life are rarely a result of a manufacturing defect.

When we receive a call right about three months after tables are put into a location that suddenly, not a single table’s battery will hold a charge, it definitely looks like a charging issue.

**Do you trust your locations to collect for you?  
Why trust them to charge your battery?**

### **BATTERY DISPOSAL:**

Lead-acid batteries should not be disposed of by just tossing them in the trash. Make sure your batteries are disposed of properly and safely. For more information, call 888-USA-4001 or visit [www.interstatebatteries.com](http://www.interstatebatteries.com) (check the “Recycling” link) to learn about Battery Recycling





# The Valley Panther ZD-X



## MEI® Bill Acceptor

In response to Operator demand, Valley has partnered with MEI for the Panther ZD-X Bill Acceptor. The MEI models that have the custom Valley Harness are.

### AE 2655 U5V

This unit takes \$1- \$20 and is standard equipment on the Valley Panther ZD-X.

### AE 2455 U5V

This unit takes \$1 - \$5 and can be purchased from other companies.

The **V** at the end of the part number signifies that the DBA works in the Valley / Dynamo pool tables. A unit without the **V** will require installation of a new harness from the company the unit was purchased from (Valley-Dynamo does not sell this harness, as we only stock the AE2655 U5V), or modifying the existing harness to match the Valley requirements.

LED Trouble code settings for MEI DBA:

- LED OFF – power off
- LED ON – OK
- 1 Flash – Bill path jammed
- 2 Flashes – from system
- 3 Flashes – Cleaning required
- 4 Flashes – Cross-Channel Blocked
- 5 Flashes – Magazine removed
- Continuous, Slow – Unit Failure – Replace Unit
- Continuous, Fast – Stacker Full



# MEI DBA DIP switch settings for Valley Panther ZD-X

## AE2455 Bill Validators Red Label

Bill Acceptance		
Switch	1	2
1 way	ON	OFF
2 way	OFF	ON
4 way	ON	ON
Switch 3		
High Acceptance	OFF	
High Security	ON	
Switch 4 5 6		
	\$1	\$2 \$5
Accept =	ON	
Reject =	OFF	

Switch 7	
1 Pulse Per Dollar	OFF
4 Pulses Per Dollar	ON
Switch 8	
Always Enable	OFF
Harness Enable	ON

## Switch 3 & 7 **OFF** All others **ON**

## AE2655 Bill Validators Green Label

Bill Acceptance		
Switch	1	2
1 way	ON	OFF
2 way	OFF	ON
4 way	ON	ON
Switch 3		
High Security	OFF	
High Acceptance	ON	
Switch 4 5		
	\$2	\$20
Accept =	OFF	
Reject =	ON	

Switch 6	
Harness Enable	OFF
Always Enable	ON
Switch 7	
1 Pulse Per Dollar	OFF
4 Pulse Per Dollar	ON
Switch 8	
Gaming Interfaces	OFF
Vending Interfaces	ON

## Switch 1 ,2 & 3 **ON** All others **OFF**

**MEI tech support – 800-345-8172**



## The Valley Panther ZD-X



### 5-Bolt Rail System

Valley debuts a new 5-bolt rail system on the Panther series tables. By using additional mounting points, the rail is more evenly secured to the table.

In addition, the rails are now secured with threaded inserts instead of T-nuts. This eliminates the small dead spots some players noticed at the rail bolt attachment points, makes the rails less susceptible to breakage and cross-threading, makes the rails easier to repair if an insert should require replacement, but most importantly, the solid mounting surface allows the D&R/Championship Dual Density rubber to perform at its best. The Dual Density rubber is engineered for a combination of long life and consistent action. Balls will rebound to the same spot every time, for a long time.

Use a flathead screwdriver or 3/8" wrench to remove or install the rails  
The recommended torque spec is 65 inch pounds.

Using the nylon spacers provided with your table and with replacement rail sets will reduce the chance of damage, but always follow the recommended torque of 65 inch pounds. Remember, with five attachment points, maximum tightness is not a priority. **TIGHTENING THE RAILS AS TIGHT AS POSSIBLE IS LIKELY TO CAUSE DAMAGE AND IS NOT A COVERED WARRANTY FAILURE.**

Use a 6mm Allen/Hex key to remove the threaded inserts from the rails



## The Valley Panther ZD-X

### Programming Basics

**RACK COST** – The base price per game for your Valley Panther ZD-X. This dollar amount should match the table’s push chute value.

**CREDIT LEVEL OPTIONS** – Up to 3 bonus pricing options available. Use these options to award extra games for a larger buy in. If the normal Rack Cost is \$2.00/game, use a Credit Level option to offer 5 games for \$5.00.

**TIME PLAY** – Use the **TIME COST** and **TIME MINUTES** settings to charge based on a time period rather than per game. The clock and Speedpool functions of the Panther ZD-X can give you more promotional options in a location.

**TIME BONUS** – Just as with Credit Level bonus pricing, you have the option to award extra time for a larger buy in. If the normal Time Play rate is \$5.00 for 30 minutes, you can offer 70 minutes for a \$10.00 buy in.

If Time Play is not appropriate for your location, this feature can be turned off.

**HAPPY HOUR** – The Valley Panther ZD-X can offer as many as 3 “Happy Hours” daily. You can program the table’s internal clock to offer reduced pricing to stimulate additional business at slow times, or increase pricing during peak hours, or even schedule free play during league hours and avoid leaving a key to the table with that location. Happy Hour pricing is available for both Rack Play and Time Play



## The Valley Panther ZD-X



## Programming Tutorial

The Valley Panther ZD-X was designed for more Operator flexibility than ever before. The League Accounting features, additional Happy Hours and auditing features were added at the request of many Operators. At the same time, those Operators who might not require so much versatility in programming can still benefit from the battery-conserving sleep mode, the time and date powered separately from the table battery, and the ability to use the program for a quick battery voltage reading. In addition, the Base Coin settings now allow the same PCB to be used worldwide. Whether you want a detailed accounting beyond the capabilities of the Great 8, or simply a few small wishlist details brought to life to make your life easier, the Valley Panther ZD-X offers more for you



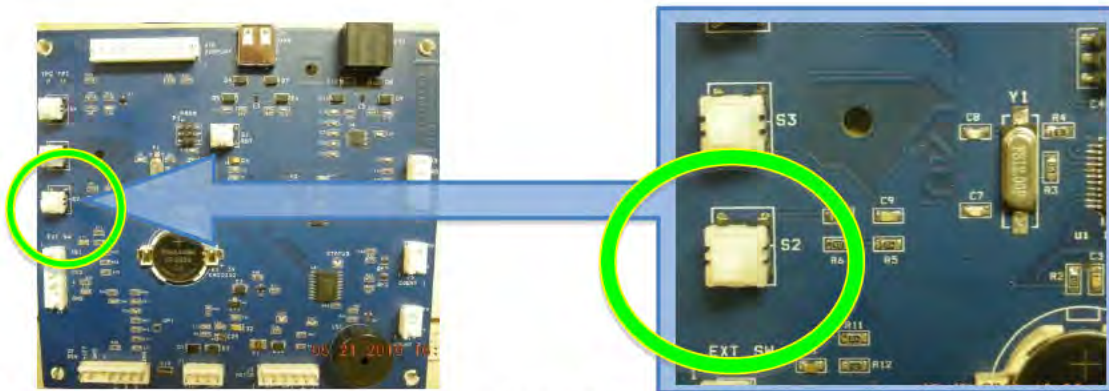

To begin programming, open the table's DBA Coin door and locate button "S2" on the main PCB

To go into program mode hold down the S2 switch as the display counts down from 5, release after your display shows



*After entering program mode, most of your programming will be done using the buttons mounted on the coin door.*



Use the **Start** button (top) to enter a program group or increase the option.

Use the **Speed Pool** button (bottom) to decrease the option.

Use the **Select** button (middle) to navigate to the next option.

When the "No" option is selected on any "Yes/No" choice, the program skips forward to the next Sub Group or program



## Programs Available

**Day and Time:** Sets the day and current time (in 24hr/military format) on your logic board.

**Default** Resets all settings to factory setting and should be done if updating the program.

**Master Setting** Use to

- A. Set the base coin
- B. USB Updating
- C. DBA Clicks
- D. International DBA On/Off
- E. Turn Speed Pool On/Off
- F. Turn Tickets On/Off
- G. Clear all Accounting
- H. Clear all League Accounting
- I. Set Sleep times
- J. Set logic serial number

**Battery Voltage** Check your battery's voltage – no meter needed.

**Accounting** See all of your accounting for

- A. Life time total
- B. Running Total
- C. Racks purchased
- D. Time Play Purchased
- E. Bonus games issued
- F. Happy Hours broken down by day by number
- G. Free Games issued
- H. Any Program errors
- I. Reset any group to zero

**League Set Up** Use this program to select

- A. What leagues to turn On/Off
- B. How many Teams per League
- C. The League Fee amount

**League Audits** For leagues that have been set up:

- A. View each league total
- B. View each team total
- C. Reset any group to Zero

**Prints Report** Use with the Serial output to print all Accounting and League dues



**Sunday** Set options for Sunday, the weekend, or the complete week.  
**Monday - Sat** Set options for each individual Day of the week

### Daily Options Available

- A. Rack On/ Off
- B. 3 Groups of Rack bonus pricing and games earned
- C. Time Play On/Off
- D. Time Bonus price and amount of minutes
- E. 3 Happy Hour settings
  - a. Start Time
  - b. Length of Happy Hour  
*Note Rack and Time Off equals Free Play*
  - c. Rack Play On/Off
  - d. Rack Cost
  - e. Time On/Off
  - f. Time Cost
  - g. Time Length
- F. You can copy Sunday settings for the Week, Weekend, or not at all

**Exit** Exits programming mode

**The daily programs are last on the menu because it is assumed that once you set them, you should not need to regularly access them, and the Accounting and League features will be used more often.**





## Program Instructions – Time and Day:

After you have entered program mode, use the **Speed Pool** and **Select** buttons to scroll to the Time-Day program group. (although Time-Day” should be the first option to appear when entering program mode).



PROGRAM GROUP:  
TIME-DAY

Press the **Start** button to enter this Program Group.

**SET HOUR** - Press the **Start** button to advance to the correct hour or the **Speed Pool** button to go backwards.

The clock is on 24H/Military time. 4 PM would be 16



SET TIME:  
16 HRS

Once the Hour is set correctly, press the **Select** button

**SET MINUTE** - Press the **Start** button to advance the minutes or the **Speed Pool** button to go backwards. Once the Minutes are set correctly, press the **Select** button

**SET DAY** - Press the **Start** button to advance the day. Once the Day has been set correctly, press the **Select** button to exit this Program Group.



SET DAY:  
FRIDAY

At this point you may continue with additional programming by selecting another group, or use the **Speed Pool** and **Select** buttons to scroll to the EXIT PROGRAM option.

**The PCB has a battery dedicated to clock function. A loss of power no longer means resetting the clock.**



## Program Instructions – Print Report:

Use this program group in conjunction with the convenient AP1300 hand held thermal printer to print out all accounting data.

To order the AP1300 Printer, contact  
Current Components Inc  
8600 Myersville Rd  
Middletown MD 21769  
Jodie Warrentfeltz  
Tel 800 342 9798 ext 215 or 216  
Fax 301 371 7353

Part number AP1300KIT1 – includes the Thermal Printer, battery pack, battery charger, serial cable, belt clip and sample roll of paper.



After you have entered program mode, use the **Speed Pool** and **Select** buttons to scroll to the Print Report program group (second option to appear when entering program mode).

Connect the printer cable to the Serial printer port on the logic board (it looks like a phone jack).

Press the **Start** button to print the report. Press the **Start** button again for an additional copy.

Press the **Select** button to exit this Program Group. At this point you may continue with additional programming options by selecting another group, or use the **Speed Pool** and **Select** buttons to scroll to the EXIT PROGRAM option.



## Program Instructions – League Audits:

After you have entered program mode, use the **Speed Pool** and **Select** buttons to scroll to the League Audits program group (third option to appear when entering program mode).

Press the **Start** button to enter this option.



League 1, Team 01 is the first total to display. By pressing the door-mounted **Select** button you will advance to the next total. After the last league total, you will return automatically to program mode.

The **Speed Pool** button will not allow you to reverse through the league totals.

To reset a total

Display that league and team's total on screen

Press the **Start** button.

The display will prompt you "Clear Total"

Press the **Start** button to choose "Yes" or "No"

Press the **Select** button to confirm your choice

You will return to the league totals listing

Repeat this process for each group you want to reset.



## Program Instructions – League Setup:

This option allows you to set up and delete leagues from the program. After you have entered program mode, use the **Speed Pool** and **Select** buttons to scroll to the League Setup program group (fourth option to appear when entering program mode).

Press the **Start** button to enter this option.

Refer to the chart below for options.

Use the **Start** button to scroll through settings options

Use the **Select** button to confirm your choice and go to the next option.

League Settings	Min	Max	Default
League 1 On / Off	Off	On	Off
League 1 Teams	2	100	2
League 1 Cost	\$1.00	\$200.00	\$10.00
League 2 On / Off	Off	On	Off
League 2 Teams	2	100	2
League 2 Cost	\$1.00	\$200.00	\$10.00
League 3 On / Off	Off	On	Off
League 3 Teams	2	100	2
League 3 Cost	\$1.00	\$200.00	\$10.00
League 4 On / Off	Off	On	Off
League 4 Teams	2	100	2
League 4 Cost	\$1.00	\$200.00	\$10.00
League 5 On / Off	Off	On	Off
League 5 Teams	2	100	2
League 5 Cost	\$1.00	\$200.00	\$10.00
League 6 On / Off	Off	On	Off
League 6 Teams	2	100	2
League 6 Cost	\$1.00	\$200.00	\$10.00
League 7 On / Off	Off	On	Off
League 7 Teams	2	100	2
League 7 Cost	\$1.00	\$200.00	\$10.00
League 8 On / Off	Off	On	Off
League 8 Teams	2	100	2
League 8 Cost	\$1.00	\$200.00	\$10.00
League 9 On / Off	Off	On	Off
League 9 Teams	2	100	2
League 9 Cost	\$1.00	\$200.00	\$10.00
League 10 On / Off	Off	On	Off
League 10 Teams	2	100	2
League 10 Cost	\$1.00	\$200.00	\$10.00



## Program Instructions – Check Battery:

This option allows you to check your Battery Voltage without a meter. After you have entered program mode, use the **Speed Pool** and **Select** buttons to scroll to the Check Battery program group (fifth option to appear when entering program mode).

Press the **Start** button and the voltage will be displayed

The **Select** button will exit and return you to program mode.

## Program Instructions – Restore Defaults:

Press the **Start** button to enter the program

Reset Defaults

No is the first option, press **Start** to change the option to Yes / No



RESTORE DEFAULT?  
YES

Press the **Select** button twice to confirm your choice and exit the program group.



FACTORY DEFAULTS  
RESTORED

“Restore Defaults” can be very handy when moving a table to an all new location with new pricing, bonus and happy hour settings – just be absolutely certain you want to restore everything. There is no “unrestore” function if you didn’t mean to do this.



## Program Instructions – Master Settings:

Many of these will be set-and-forget values rarely requiring change so long as a table remains in one location.

Press the **Start** button to enter the program group followed by the **Select** button to navigate to option you want to change.

### **SET THE BASE COIN - in the USA keep this setting at \$0.25.**

Press the **Start** button to enter this option

Use the **Start** button to choose the base coin. (\$0.05, \$0.10, \$0.25, \$0.50 or \$1.00)

**USA setting should remain at \$0.25.**

Press the **Select** button to save your choice.

Confirm your change of the Base Coin Yes / No

Use the **Start** button to select yes or no.

Press the **Select** button to save and proceed to the next program Option.

**If the Base Coin has been changed, you must clear all Accounting and Leagues and reset the Defaults. Avoid changing the Base Coin.**

### **USB UPDATING – complete instructions available on page 36**

Press the **Start** button to enter this option

Use the **Start** button to choose.

- **TABLE ONLY** - will upload only your daily settings from the USB memory stick TO the table.
- **LEAGUE ONLY** - will upload only your league settings from the USB memory stick TO the table.
- **TABLE AND LEAGUE** - will Upload both table and league settings from the USB memory stick TO the table.
- **NO USB UPDATING** - will only Download your accounting to the USB Memory stick FROM the table.

Press the **Select** button to save your option and move to the next option.

IF you selected to upload from the USB to the table. After you EXIT the program.

Place a formatted USB memory stick in the onboard USB and press the Reset Button on the controller PCB.

### **DBA CLICKS – in the USA keep this set to 04**

**This option adjusts the number of clicks the coin counter registers per bill.**

Press the **Start** button to enter this option

Use the **Start** button to choose between 1 – 10 pulses.

Press the **Select** button to save your Settings, and move to the next option.

**INTERNATIONAL DBA** Default Off. This option lets you choose between an ICT DBA and MEI (MARS) DBA.

Press the **Start** button to enter this option

Use the **Start** button to choose between On/Off



Off for MEI USE

On for ICT USE.

Press the **Select** button to save your Settings, and move to the next option.

IF YOU CHANGED THIS SETTING, after you exit the program, Press the Reset button to put the change into effect.

#### **TURN SPEED POOL ON/OFF -**

Press the **Start** button to enter this option

Use the **Start** button to choose On or Off

Press the **Select** button to confirm and proceed to the next option.

#### **TURN TICKETS POOL ON/OFF – for tables without ticket dispensers keep this setting at off.**

Press the **Start** button to enter this option

Use the **Start** button to choose On or Off

Press the **Select** button to confirm and proceed to the next option.

#### **CLEAR ALL ACCOUNTING -**

Press the **Start** button to enter this option

Use the **Start** button to choose Yes or No

- **BE SURE – YOU CANNOT RESTORE THE TOTALS ONCE CLEARED**

Press the **Select** button to confirm

Press **Select** again to proceed to the next option.

#### **CLEAR ALL LEAGUE ACCOUNTING**

Press the **Start** button to enter this option

Use the **Start** button to choose Yes or No

- **BE SURE – YOU CANNOT RESTORE THE TOTALS ONCE CLEARED**

Press the **Select** button to confirm

Press **Select** again to proceed to the next option.

#### **SET SLEEP HOURS – for battery conservation.**

##### **Does the table need to be “awake” and drawing power when the location is closed?**

Press the **Start** button to enter this option

Use the **Start** button to choose Yes or No (default is no)

If yes, choose the sleep time using the **Start** button

Program scrolls in 15-minute increments and uses 24-hour time.

11:30pm is “23:30”

Press the **Select** button to confirm your setting

Now use the **Start** button to set the wake up time

Program scrolls in 15-minute increments and uses 24-hour time.

11:30pm is “23:30”

Press the **Select** button to confirm and proceed to the next set of options

**SET LOGIC SERIAL NUMBER** - user programmable value to track a particular table or board for accounting purposes.

Press the **Start** button to enter this option



Use the **Start** button to choose Yes or No (default is no)  
Press the **Select** button to confirm your setting  
Use the **Start** button to scroll to your desired serial number.  
Press the **Select** button to confirm your setting and return to the Program Group.

## Program Instructions – Accounting:

Press the **Start** button to enter this option. You can find detailed information here on not only how much money your table made, but what pricing options were most popular with your customers.

You can navigate forward through the totals by pressing the **Select** button. This option will display totals since the most recent reset for the following:

- Total earnings
- Racks played
- Time Play
- Bonus Rack 1
- Bonus Rack 2
- Bonus Rack 3
- Bonus Time
- Sunday Happy Hour 1
- Sunday Happy Hour 2
- Sunday Happy Hour 3

(the next 18 values are displays for the 3 Happy Hours for each day of the week)

- Free play games
- RTC OSC errors

Press **Select** again after viewing or resetting RTC OSC errors and you will automatically exit the group

To reset a value to 0,

Navigate to that value

Press the **Start** button

The display will prompt you “Clear Total” Yes or No

**THERE IS NO RESTORE FUNCTION  
BE SURE YOU WANT TO PROCEED**

Press the **Start** button to choose.

Press the **Select** button to confirm your choice

Program will advance to the next option group.

Repeat this process for each group you want to reset.





## Program Instructions – Daily Programs:

This table lists the programming options available for each day of the week, and the range of values allowed

Sub Groups	Min	Max	Default	New Setting
DAILY Rack Play	Off	On	On	
DAILY Rack Cost	0.25	\$20.00	\$2.00	
DAILY Group 1 Bonus Pricing	Off	On	On	
DAILY Group 1 Bonus Cost	\$1.00	\$20.00	\$5.00	
DAILY Group 1 Bonus Games Awarded	2	40	5	
DAILY Group 2 Bonus Pricing	Off	On	Off	
DAILY Group 2 Bonus Cost	\$1.00	\$20.00	-	
DAILY Group 2 Bonus Games Awarded	2	40	-	
DAILY Group 3 Bonus Pricing	Off	On	Off	
DAILY Group 3 Bonus Cost	\$1.00	\$20.00	-	
DAILY Group 3 Bonus Games Awarded	2	40	-	
DAILY Time Play	Off	On	Off	
DAILY Time Cost	\$0.25	\$60.00	-	
DAILY Play Minutes	5	120	-	
DAILY Time Bonus	Off	On	Off	
DAILY Time Bonus Cost	\$0.25	\$60.00	-	
DAILY Time Bonus Minutes	5	120	-	
DAILY Happy Hour 1	Off	On	Off	
DAILY Happy Hour Start Time	0:00	0:00	-	
DAILY Happy Hour 1 Duration	0:15	0:00	-	
DAILY Happy Hour 1 Rack	Off	On	Off	
DAILY Happy Hour 1 Rack Cost	\$1.00	\$20.00	-	
DAILY Happy Hour 1 Time	Off	On	Off	
DAILY Happy Hour 1 Time Cost	\$0.25	\$20.00	-	
DAILY Happy Hour 1 Time Minutes	5	120	-	
DAILY Happy Hour 2	Off	On	Off	
DAILY Happy Hour Start Time	0:00	23:45	-	
DAILY Happy Hour 2 Duration	0:15	24:00:00	-	
DAILY Happy Hour 2 Rack	Off	On	Off	
DAILY Happy Hour 2 Rack Cost	\$0.25	\$20.00	-	
DAILY Happy Hour 2 Time	Off	On	Off	
DAILY Happy Hour 2 Time Cost	\$0.25	\$20.00	-	
DAILY Happy Hour 2 Time Minutes	5	120	-	
DAILY Happy Hour 3	Off	On	Off	
DAILY Happy Hour Start Time	0:00	23:45	-	
DAILY Happy Hour 3 Duration	0:15	120	-	
DAILY Happy Hour 3 Rack	Off	On	Off	
DAILY Happy Hour 3 Rack Cost	\$0.25	\$20.00	-	
DAILY Happy Hour 3 Time	Off	On	Off	
DAILY Happy Hour 3 Time Cost	\$0.25	\$20.00	-	
DAILY Happy Hour 3 Time Minutes	5	120	-	



You can navigate through the seven days of the week for individual programming. Sunday is listed first because the software is engineered to allow the user to copy Sunday settings to all seven days, or just for the weekend. This way, there is no need to enter the same settings seven times if you want them the same throughout the week.

## BEFORE YOU BEGIN PROGRAMMING REMEMBER THE BUTTON FUNCTIONS



Use the **Start** button (top) to enter a program group

Within the group, use the **Start** button (top) to increase the option.

Use the **Speed Pool** button (bottom) to decrease the option.

Use the **Select** button (middle) to navigate to the next option.

When the “No” option is selected on any “Yes/No” choice, the program skips forward to the next Sub Group or program group.



In this program group you set all of your game and pricing options for Sunday. Sunday programming was engineered for copying. You have the option after navigating through the Sunday programs to copy Sunday’s programming can be copied to cover the complete week or weekend if desired.

### Rack Play ON



Rack Play On - proceed to Rack cost

### or Rack Play OFF



Rack Play Off will skip to Time Play On/Off

**Note:** Turning Rack Play and Time Play Off will set the game to Free Play and will advance you to the Happy Hour Options.



### Rack Cost



Press the **Start** button to increase the value and the **Speed Pool** button to decrease the value. The option range is from \$0.25 - \$20.00

Press the **Select** button to confirm your choice and advance to the next option.

### Credit Level 1

This sets the base amount to earn bonus games.

#### Credit Level ON



Credit On, proceed to credit Cost

or

#### Credit Level OFF



Credit Off will skip to Time Play on/off

Choose between Credit 1 On or Off by pressing the **Start** Button.

Press the **Select** button to confirm your choice and advance to the next option.

### Credit 1 Cost

This sets the base dollar amount to earn bonus (extra) racks.



Press the **Start** button to increase the value and the **Speed Pool** button to decrease the value in \$0.25 increments. The option range is from \$0.25 - \$20.00

Press the **Select** button to confirm your choice and advance to the next option.

### Total games earned for credit level amount.

Set the number of games purchased for the base dollar amount just set.



This setting overrides the normal price per game settings.

Press the **Start** button to increase the value and the **Speed Pool** button to decrease the value between 2 and 27 games.

Press the **Select** button to confirm your choice and advance to the next option.



You may repeat settings for Credit Level 2 and 3 using the same steps, if desired  
Otherwise, select OFF (or leave OFF unchanged to continue navigating)

**Time Play: on this level you will turn Time play On or Off. If Time Play is not appropriate for your location or customers, is easier if this option is simply turned off**

### Time Play ON or OFF



**Time Play On, proceed to Time Cost**

**Time Play Off, you will skip ahead to Happy Hour 1**

Choose between Time Play On or Off by pressing the **Start** Button.  
Press the **Select** button to confirm your choice and advance to the next option.

### Time Cost

Sets the base dollar amount that must be paid for Time Play.



Press the **Start** button to increase the value and the **Speed Pool** button to decrease the value. The option range is in \$0.25 increments from \$0.25 - \$60.00  
Press the **Select** button to confirm your choice and advance to the next option.

### Time Minutes

Sets the number of minutes purchased for the base dollar amount just set.



Press the **Start** button to increase the value and the **Speed Pool** button to decrease the value. The option range is from 5 minutes – 120 minutes.  
Press the **Select** button to confirm your choice and advance to the next option.



### **Time Bonus**

**Used to offer additional play time as incentive for a larger purchase**

#### **Time Bonus ON or OFF**



**Time Bonus On, proceed to Bonus Cost**

**Time Bonus Off, skip ahead to Happy Hour 1**

Choose between Time Bonus On or Off by pressing the **Start** Button.

Press the **Select** button to confirm your choice and advance to the next option.

#### **Time Bonus Cost**

**Sets the base dollar amount to earn bonus (extra) time play.**



Press the **Start** button to increase the value and the **Speed Pool** button to decrease the value. The option range is in \$0.25 increments from \$0.25 - \$60.00

Press the **Select** button to confirm your choice and advance to the next option.

#### **Amount of time Purchased**

**Sets the number of minutes purchased for the amount you set in the step above.**

**This setting overrides the base time play settings.**



Press the **Start** button to increase the value and the **Speed Pool** button to decrease the value. The option range is from 5 minutes – 120 minutes.

Press the **Select** button to confirm your choice and advance to the next option.



**HAPPY HOUR SETTINGS:** Happy Hour can be a very effective tool for stimulating pool business during otherwise slow times. Better to have the table vending pool and earning a little less, than not earning at all. This may also have the effect of increasing the location’s business when word spreads (and it will) that a location is offering discounted pool. The operator wins when collecting, the location wins with business, the players win with a price break.

There are 3 happy hour groups, each group has the same options and it programmed in the exact same manner.

**IMPORTANT** – The Panther ZD-X software has protection to prevent Happy Hour start times from overlapping. If you overlap the hours you will get the following message



and be returned to the start time. If so, adjust your start time to correct the overlap and continue with your programming.

A reminder, any programming steps will be virtually identical for Happy Hour 2 or 3. If you decide to turn off a Happy Hour you will skip ahead to the end of that day’s programming.

If you want to vend **FREE POOL** during Happy Hour (such as for a League Night), set both **Rack Play** and **Time Play** to off when programming.

**Happy Hour Programming**

Happy Hour 1 ON

Or

Happy Hour 1 OFF



Happy Hour 1 On, proceed to Start time

Off, skip forward to the advance to the end

Choose between Happy Hour On or Off by pressing the **Start** Button. Press the **Select** button to confirm your choice and advance to the next option.



### Happy Hour 1 Start

Set the start time for Happy Hour 1



Press the **Start** button to increase the value and the **Speed Pool** button to decrease the value. The option range is in :15 minute increments from 0:00A.M. to 23:45 P.M.

Press the **Select** button to confirm your choice and advance to the next option.

### Happy Hour 1 Length

Set the amount of time Happy Hour 1 will last



On this option you are setting how long the Happy Hour will last - the image above shows the Happy Hour lasting for 45 minutes.

Press the **Start** button to increase the value and the **Speed Pool** button to decrease the value. The option range is in :15 minute increments until the end of the day.

**Happy Hours are based on a 24 hour clock and cannot pass 24:00 (Midnight)**

Press the **Select** button to confirm your choice and advance to the next option.

### Happy Hour 1 Rack

Use this option if your Happy Hour will offer special pricing on Rack Play

Happy Hour Rack Play ON

or

Happy Hour 1 Rack Play OFF



Rack On, proceed to Rack Cost

Rack Off, skip to Time Play

Choose between Rack Play On or Off by pressing the **Start** Button.

Press the **Select** button to confirm your choice and advance to the next option.

### Happy Hour 1 Rack \$

Set the special Rack Play pricing for Happy Hour 1



Use the **Start** button to increase the value and the **Speed Pool** button to decrease the value. The option ranges in \$0.25 increments from \$0.25 - \$20.00

Press the **Select** button to confirm your choice and advance to the next option.



### Happy Hour 1 Time

Use this option if your Happy Hour will offer special pricing on Time Play

HH 1 Time Play ON



HH1 Time On, proceed to Time Cost

Or

HH 1 Time Play OFF



HH1 Time Off, skips to the end

Choose between Time Bonus On or Off by pressing the **Start** Button.  
Press the **Select** button to confirm your choice and advance to the next option.

### HH1 Time \$

Set the special Time Play pricing for Happy Hour 1



Press the **Start** button to increase the value and the **Speed Pool** button to decrease the value. The option range is in \$0.25 increments from \$0.25 - \$60.00  
Press the **Select** button to confirm your choice and advance to the next option.

### HH1 Time Min

Sets the number of minutes purchased for the amount set in the step above.



Press the **Start** button to increase the value and the **Speed Pool** button to decrease the value. The option range is from 5 minutes – 120 minutes.  
Press the **Select** button to confirm your choice and advance to the next option.

**At this point you will advance to the setting for Happy Hour 2, procedure and available settings are virtually identical to those for HH1.**

**If you set values for Happy Hour 2, you will then advance to the settings for Happy Hour 3.**





### Copy Settings –

To save time and effort, the Sunday programming has the ability to copy the daily settings. There are three available options:



**ALL WEEK** copies the Sunday settings to all seven days of the week

**WEEKEND** copies Sunday's settings to **FRIDAY** and **SATURDAY** only

Or choose not to copy the settings at all, leaving them **SUNDAY** only.

Use the **Start** button to select from the available choices, and **Select** to confirm.

The Copy option is the last available programming setting available for Sunday. After confirming whether to copy the Sunday settings, the system returns to the Program Group menu. Press the door-mounted **Start** button to enter the Monday program group or **Select** to forward to each day of the week. Program the days of your choice, skip those days where you only want to use the base pricing.

For each day of the week, the same programming options are offered, and they are programmed in the same way. The only difference from the Sunday instructions is in the day of the week.

The expanded accounting capabilities of the Panther ZD-X can give you a clear understanding of your most successful pricing and options. **Successful operators will review their accounting periodically to maximize collections.** Build on successful strategies. Replace or change unsuccessful options.

Do not view the programming options as “set once and forget it until you move the table.” **The Panther ZD-X wants to help you increase your earnings!**

It just needs a little help from you to make it happen.



The following chart details all sub groups and options available.

Sub Groups	Min	Max	Default	Sun	Mo	Tu	W	Th	Fri	Sat
DAILY Rack Play	Off	On	On							
DAILY Rack Cost	0.25	\$20.00	20							
DAILY Group 1 Bonus Pricing	Off	On	On							
DAILY Group 1 Bonus Cost	\$1.00	\$20.00	\$5.00							
DAILY Group 1 Bonus Games	2	40	6							
DAILY Group 2 Bonus Pricing	Off	On	Off							
DAILY Group 2 Bonus Cost	\$1.00	\$20.00	\$10.00							
DAILY Group 2 Bonus Games	2	40	13							
DAILY Group 3 Bonus Pricing	Off	On	Off							
DAILY Group 3 Bonus Cost	\$1.00	\$20.00	\$20.00							
DAILY Group 3 Bonus Games	2	40	27							
DAILY Time Play	Off	On	On							
DAILY Time Cost	\$0.25	\$60.00	\$5.00							
DAILY Play Minutes	5	120	30							
DAILY Time Bonus	Off	On	Off							
DAILY Time Bonus Cost	\$0.25	\$60.00	\$10.00							
DAILY Time Bonus Minutes	5	120	70							
DAILY Happy Hour 1	Off	On	Off							
DAILY Happy Hour Start Time	0:00	0:00	12:00							
DAILY Happy Hour 1 Duration	0:15	0:00	1:00							
DAILY Happy Hour 1 Rack	Off	On	Off							
DAILY Happy Hour 1 Rack Cost	\$1.00	\$20.00	\$1.00							
DAILY Happy Hour 1 Time	Off	On	Off							
DAILY Happy Hour 1 Time Cost	\$0.25	\$20.00	\$5.00							
DAILY Happy Hour 1 Time Minutes	5	120	20							
DAILY Happy Hour 2	Off	On	Off							
DAILY Happy Hour Start Time	0:00	23:45	12:00							
DAILY Happy Hour 2 Duration	0:15	24:00:00	1:00							
DAILY Happy Hour 2 Rack	Off	On	Off							
DAILY Happy Hour 2 Rack Cost	\$0.25	\$20.00	\$1.00							
DAILY Happy Hour 2 Time	Off	On	Off							
DAILY Happy Hour 2 Time Cost	\$0.25	\$20.00	\$5.00							
DAILY Happy Hour 2 Time Minutes	5	120	20							
DAILY Happy Hour 3	Off	On	Off							
DAILY Happy Hour Start Time	0:00	23:45	12:00							
DAILY Happy Hour 3 Duration	0:15	120	1:00							
DAILY Happy Hour 3 Rack	Off	On	Off							
DAILY Happy Hour 3 Rack Cost	\$0.25	\$20.00	100							
DAILY Happy Hour 3 Time	Off	On	Off							
DAILY Happy Hour 3 Time Cost	\$0.25	\$20.00	\$5.00							
DAILY Happy Hour 3 Time Minutes	5	120	20							

Use this chart to help plan your weekly programming





# The Valley Panthe

# USB Memory

Your Panther ZD-X™ only supports USB Memory Sticks that are 2GB in size and SMALLER that have been formatted for FAT. USB sticks that are formatted with FAT32 are not supported. A larger USB stick (4GB, 8GB, etc) formatted to FAT may work. To check the formatting of your memory stick, go to My Computer, right click on the USB stick and select properties.

As you can see in this screenshot the FILE system is shown as FAT.

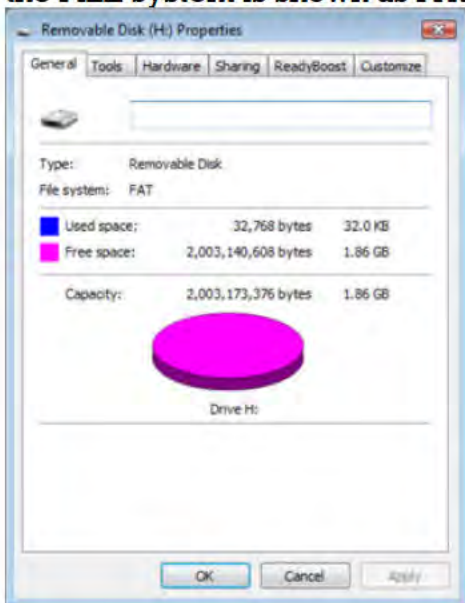
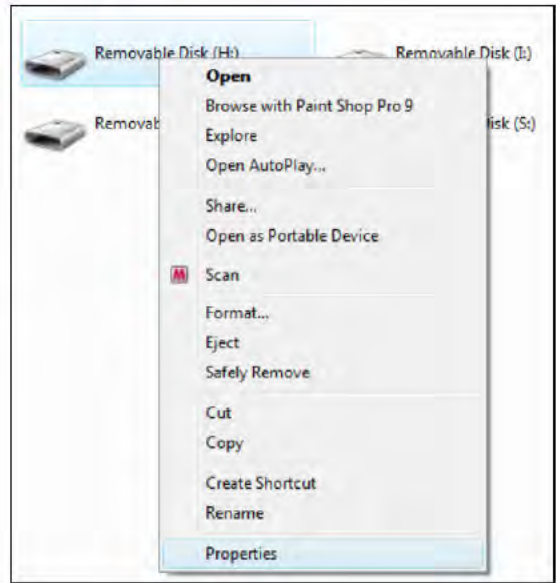

Consult the HELP guide in Microsoft Windows for directions on formatting a USB key in FAT, or reformatting from FAT 32. We know Pool Tables, but Microsoft knows working with Windows.

**CAUTION** when formatting any USB memory key, ALL DATA ON IT WILL BE ERASED



## How to Copy Settings from the Table to the USB Memory Stick

- Once you have table set up the way you want to, insert a **blank** memory stick into the USB port ( J9 ) of your Panther ZD-X™ control board. Press the S1 / RST button on the middle of the board.
- After a few moments, the display of your Panther ZD-X™ table will show the version number of the table, and then will display a message stating.
- SAVED TO USB
- After a few seconds you will then see the following message
- LEAGUE SAVED TO USB
- Once you see this message you can remove the USB memory stick.
- There will be a file on the USB stick called **TABLE.CSV**.

**Now that you have *TABLE.CSV* on the USB memory stick, you can clone the settings to other tables on your route by following the steps listed under USB UPDATING on page 22 in Master Group section.**

### **TABLE.CSV**

All of this information is saved into a file on your table called TABLE.CSV. CSV stands for **comma separated value**. CSV files can be edited in Microsoft Excel, Apple Numbers, or simple text editing programs. You can open this file and edit it on your PC.

Please be careful when editing the file. Excel, Numbers and other programs will only know that there are numbers in the blanks, but are totally unable to understand if your Panther ZD-X will understand the numbers.



If you open TABLE.CSV in a program like Microsoft Excel, you will see a view similar to this one. This image has the editable cells highlighted.

PANTHER ZD-X	SUNDAY	MONDAY	TUESDAY	WEDNESDAY	THURSDAY	FRIDAY	SATURDAY
RACK PLAY?	1	1	1	1	1	1	1
RACK COST	40	20	20	20	20	40	20
LEVEL 1 BONUS	1	1	1	1	1	1	1
LEVEL 1 COST	100	100	100	100	100	120	100
LEVEL 1 GAMES	6	6	6	6	6	8	6
LEVEL 2 BONUS	1	0	0	0	0	0	0
LEVEL 2 COST	200	200	200	200	200	200	200
LEVEL 2 GAMES	13	13	13	13	13	13	13
LEVEL 3 BONUS	0	0	0	0	0	0	0
LEVEL 3 COST	400	400	400	400	400	400	400
LEVEL 3 GAMES	27	27	27	27	27	27	27
TIME PLAY	0	0	0	0	0	0	0
TIME COST	100	100	100	100	100	100	100
TIME MINUTES	6	6	6	6	6	6	6
TIME BONUS	0	0	0	0	0	0	0
TIME BONUS COST	200	200	200	200	200	200	200
TIME BONUS MINUTES	14	14	14	14	14	14	14

Rack play, Time Play and Bonus – a yes/no setting – use 1 for “YES/ON”, 0 for “NO/OFF”

Rack Cost, Bonus Cost and Time Cost are settings in multiples of 0.05.

- A Rack Cost of \$2.00 would be set as 40 ( $\$2.00 / 0.05 = 40$ )
- A Rack Cost of \$1.00 would be set as 20 ( $\$1.00 / 0.05 = 20$ )
- A Time Bonus Cost of \$10.00 would be set as 200 ( $\$10.00 / 0.05 = 200$ )

Games are really simple – 6 means 6 games, 10 means 10 games, and so forth.

Minutes are also simple – 14 means 14 minutes



Below the main table settings you will find the advanced settings for Happy Hour pricing

	SUN	MON	TUE	WED	THR	FRI	SAT
HAPPY HOUR 1	0	0	0	0	0	0	0
HAPPY HOUR 1 START	48	48	48	48	48	48	48
HAPPY HOUR 1 DURATION	4	4	4	4	4	4	4
HAPPY HOUR 1 RACK PLAY	0	0	0	0	0	0	0
HAPPY HOUR 1 RACK COST	20	20	20	20	20	20	20
HAPPY HOUR 1 TIME PLAY	0	0	0	0	0	0	0
HAPPY HOUR 1 TIME PLAY COST	100	100	100	100	100	100	100
HAPPY HOUR 1 TIME MINUTES	4	4	4	4	4	4	4
HAPPY HOUR 2	0	0	0	0	0	0	0
HAPPY HOUR 2 START	48	48	48	48	48	48	48
HAPPY HOUR 2 DURATION	4	4	4	4	4	4	4
HAPPY HOUR 2 RACK PLAY	0	0	0	0	0	0	0
HAPPY HOUR 2 RACK COST	20	20	20	20	20	20	20
HAPPY HOUR 2 TIME PLAY	0	0	0	0	0	0	0
HAPPY HOUR 2 TIME PLAY COST	100	100	100	100	100	100	100
HAPPY HOUR 2 TIME MINUTES	4	4	4	4	4	4	4
HAPPY HOUR 3	0	0	0	0	0	0	0
HAPPY HOUR 3 START	48	48	48	48	48	48	48
HAPPY HOUR 3 DURATION	4	4	4	4	4	4	4
HAPPY HOUR 3 RACK PLAY	0	0	0	0	0	0	0
HAPPY HOUR 3 RACK COST	20	20	20	20	20	20	20
HAPPY HOUR 3 TIME PLAY	0	0	0	0	0	0	0
HAPPY HOUR 3 TIME PLAY COST	100	100	100	100	100	100	100
HAPPY HOUR 3 TIME MINUTES	4	4	4	4	4	4	4

Happy Hour 1, 2, 3 – a yes/no setting – use 1 for “YES/ON”, 0 for “NO/OFF”

Happy Hour Start is tricky, it is set up in 15-minute segments.

- For 12:30am, set at 2 (12:00am + 30 minutes (2 x 15) = 12:30am)
- For 12:00pm, set at 48 (12:00am + 720 minutes (48 x 15) = 12:00pm)
- For 4:00pm, set at 64 (12:00am + 960 minutes (64 x 15) = 4:00pm)

Duration is also set in 15-minute segments

- A duration of 4 = 1 hour
- A duration of 8 = 2 hours

Rack Cost, Bonus Cost and Time Cost remain settings in multiples of 0.05.

Games and Minutes remain as before



### **League Settings**

The table can have 10 leagues with 100 teams per league.

### **League State**

This is an On / Off value.

### **League Teams**

This is the number of teams in that league.

### **League Fees**

This is how much it costs to participate in the league, in whole dollars.

### **Audits**

You will also notice that the Audits of your table are saved into the **TABLE.CSV** file. As you move the USB memory stick from table to table, the file TABLE.CSV will grow as more audit information is appended to the file. You will have to take advantage of the table serial number feature in order to keep everything straight.





# The Valley Panther ZD-X

## ZD-X Wiring Schematic

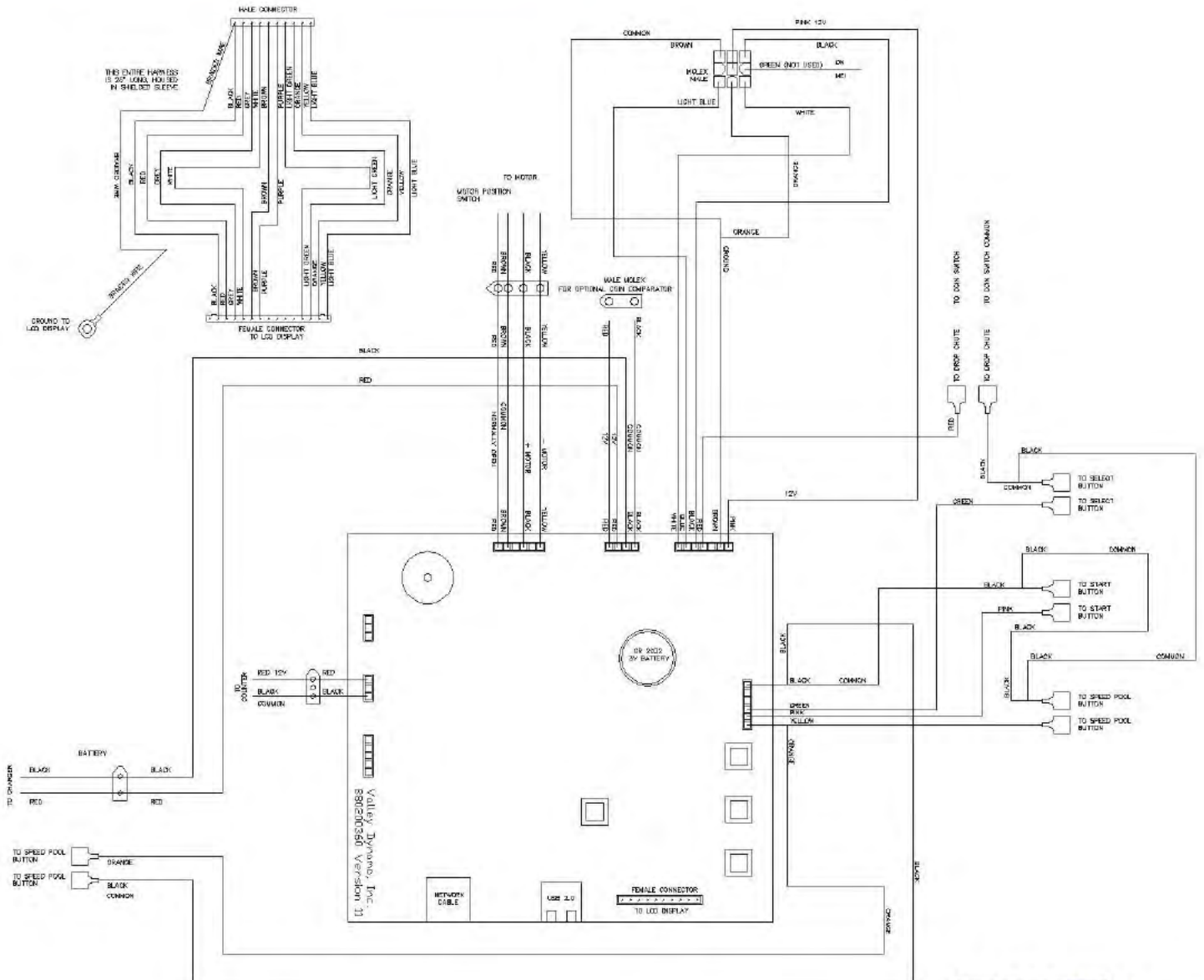



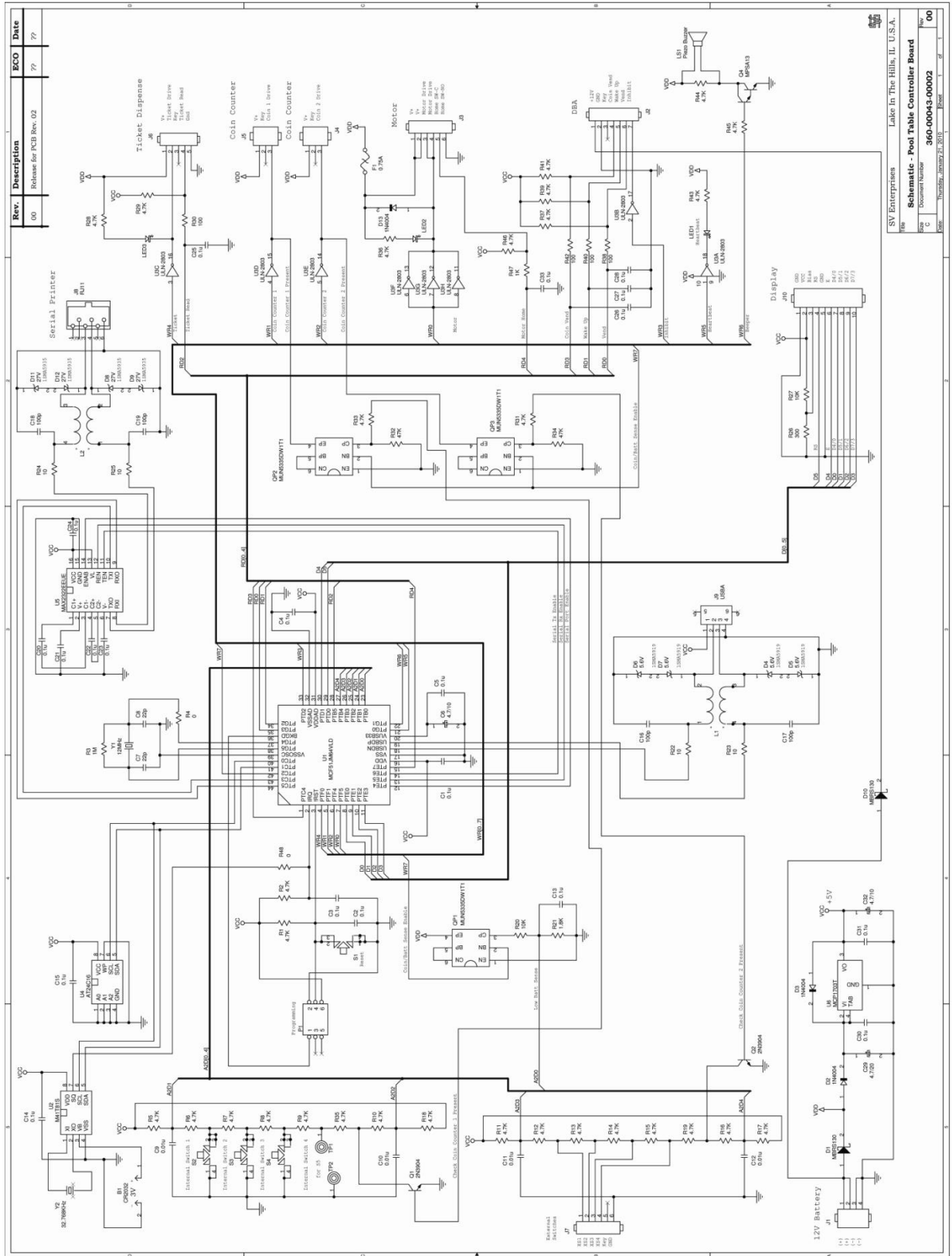

Rev.	Description	ECO	Date
00	Release for PCB Rev. 02	77	77

SV Enterprises  
 Lake in The Hills, IL U.S.A.  
**Schematic - Pool Table Controller Board**  
 Doc# 360-00043-00002  
 Rev 00  
 Thursday, January 21, 2011





## The Valley Panther ZD-X

### ESD Push Chute

The Panther ZD-X is equipped with a push chute so that if the battery protection measures and reminders to keep the battery charged all still result in a dead battery, your Panther ZD-X still has a way to be used. Setting the dollar value of your table is not fully complete unless you set the push chute to match.



1) Remove the Push Chute from the coin door, and remove the push chute end, proximity plate, anything bolted to the end— for easier access. You will need the Push Chute (of course), enough coins to make it work in its current setting, the inserts for the desired setting, and a Phillips screwdriver.

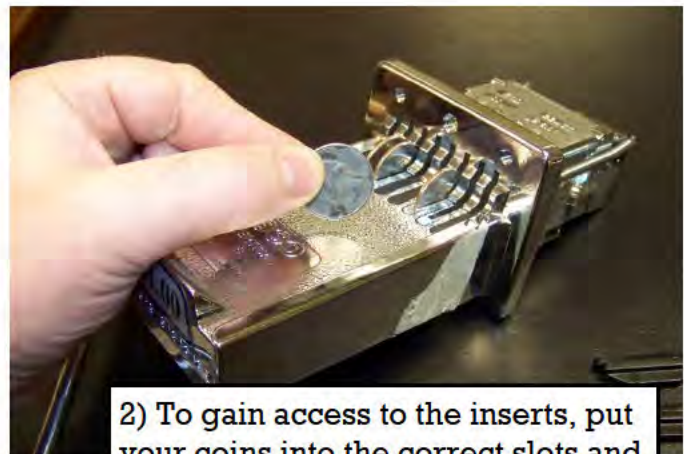

2) To gain access to the inserts, put your coins into the correct slots and then push in the handle.





3) After pushing in the chute and your coins drop out, you will be able to access the inserts, and a section that may contain spare inserts. Continue to hold the handle in as shown...



4) and unhook the two large return springs from the small hooks on the spring bracket.

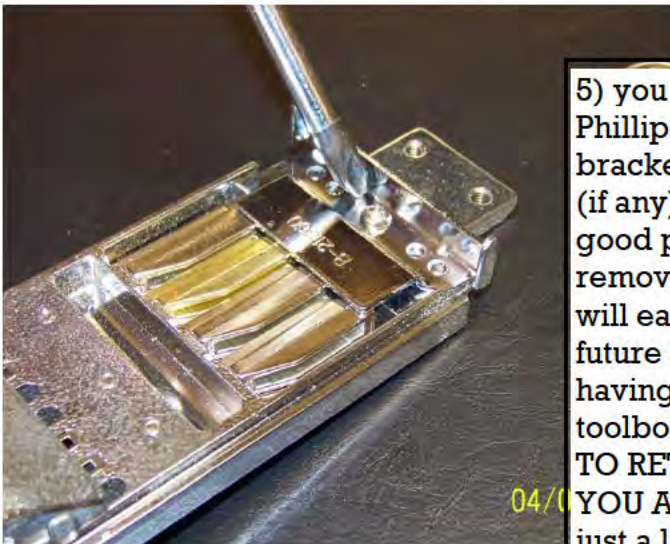

5) you can remove the single Phillips screw holding the spring bracket to access the spare inserts (if any). This will also be a very good place to store any inserts you remove during this process so you will easily be able to find them for future adjustments, and aren't having to dig in your workbench, toolbox, desk drawer, etc.. **BE SURE TO RETIGHTEN THIS SCREW ONCE YOU ARE DONE**, if it is sticking up just a little the unit will not move freely. No need to use Olympic-caliber strength, just make sure it is snug. Now turn the unit over.



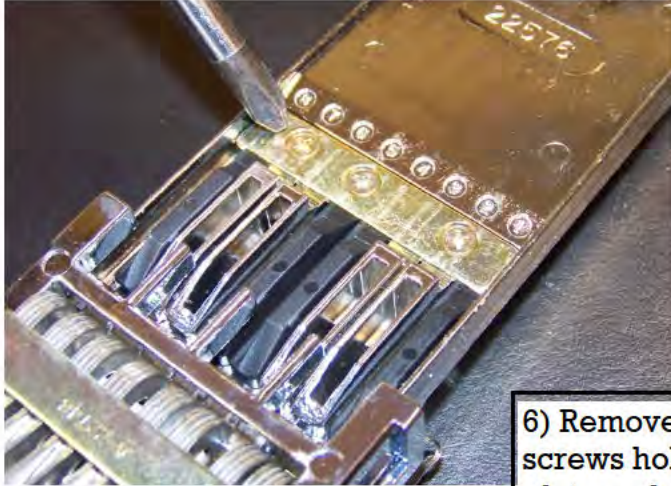

6) Remove the Phillips screw or screws holding the insert retainer plate and you will have access to all the inserts.

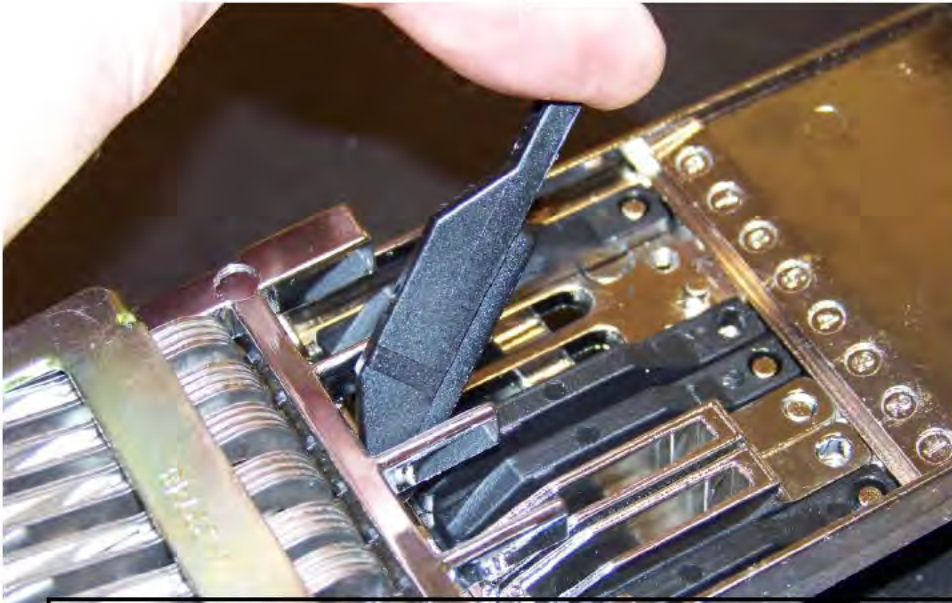

7) With the Insert Retainer Plate removed, you have ready access to make whatever changes you see fit. Switch coin inserts with blanks, or switch blank inserts for coins. When finished, it is important that the Insert retainer Plate is attached snugly so the unit will move freely and not catch on the plate or screws. Once the Insert Retainer Plate and Spring Bracket are snugly attached, reconnect the return springs, and test that the handle moves smoothly. If you've installed blanks, just give it a push. If you've set your Push Chute for coin use, you'll need the correct coins so it will work.





- 20100020 Trim Screw
- 20200020 Cushion bolt
- 20200030 Leg Bolt
- 20608000 Valley Panther Corner Castings
- 20607560 Leg Leveler
- 20600042 Valley Panther Pocket Liner Corner
- 20600043 Valley Panther Pocket Liner Side
- 20900016 Saluc Duramith Ball Set
- 20900046 Duramith Cue ball
- 720203088 Valley Panther Side Trim MDL 88
- 720203093 Valley Panther Side Trim MDL 93
- 720203101 Valley Panther Side Trim MDL 101
- 720203188 Valley Panther End Trim MDL 88
- 720203193 Valley Panther End Trim MDL 93
- 720203201 Valley Panther End Trim MDL 101

**ELECTRONICS**

- 880200100 MEI MARS DOLLAR BILL ACCEPTOR \$1 -\$20
- 880200131 Motor
- 880200360 Logic Board Panther Ver 11
- 880200520 Battery 18Amp Interstate
- 880200550 Charger 3 Amp
- 880200620 Display LCD
- 730200430 Cabinet Wire Harness
- 730200558 Battery Wire Harness





**The Valley Panther ZD-X Service manual is a work in progress. Our goal is to offer you instructions that explain the functions of the table without being too difficult or intimidating. Sometimes, too much information is as big a problem as not enough.**

**We invite your comments on areas that may be incomplete or confusing.**

**During business hours, you can reach a Tech support Professional by dialing 972.595.5300 and pressing Option #2.**

**Or you may contact [techhelp@valley-dynamo.com](mailto:techhelp@valley-dynamo.com)**

**We've seen it all,  
if we haven't, we probably ought to know about it!!**

