



Setup and Operation Service Manual

For use with:
Panorama Cabinet
32" and 42" Dedicated Cabinets

Revision HD-1.29-9.25-1



Big Buck HD® Copyright 2012 Play Mechanix™ Inc.

This software is based in part on the work of the Independent JPEG Group.

This product includes software developed by the OpenSSL Project for use in the OpenSSL Toolkit. (<http://www.openssl.org/>)

This product includes cryptographic software written by Eric Young (ey@cryptsoft.com)

Table of Contents

Safety	3
Product Specifications.....	5
Setup	6
Panorama Cabinet Setup	6
32" or 42" Dedicated Cabinet Setup.....	13
Big Buck HD® Setup Wizard	14
Maintenance	17
Diagnostic Menu System.....	19
Menu Screens and Descriptions	20
Adjustments	20
Audits	24
Online.....	25
Resets.....	30
System Information.....	30
Tests	33
Utilities	36
CoinUp®.....	40
Troubleshooting.....	48
Parts	52
Electrical Wiring	61
Contact Information.....	62



Safety

OPERATION

Before operating game, read this manual. Failure to properly install and operate this game could result in malfunction or accident. Operate the game in accordance with the manual.

TRANSPORTING

Cabinet is very heavy and contains fragile components. Use appropriate care when moving or transporting cabinet. Avoid rough handling.

HANDLING COMPONENTS

Many components are extremely sensitive to handling, environmental and Electrostatic Discharge (ESD) events—especially the computer. Do not handle it roughly. Before servicing, call your distributor and inquire about the PC warranty. Use proper ESD procedures when servicing. Protect components from harmful environmental conditions, such as extreme temperatures, excessive moisture or other damaging effects.

DISCONNECT POWER

Always turn off power and unplug the unit before servicing or making adjustments, unless otherwise instructed. Installing or repairing components while power is on can damage the components and void the warranty.

GROUNDING

Avoid electrical shock. Do not plug in AC power until you have inspected and properly grounded the unit. Only plug into a grounded, three-wire outlet. Do not use a “cheater” plug or cut off the ground pin on the line cord.

ELECTRICAL SHOCKS

There is no isolation transformer in the cabinet. Disconnect AC power before servicing. However, be aware that lethal voltages can remain in the electronic components even when AC power is disconnected. Use extreme caution when servicing. Verify that there is a working ground connection. If the unit sustains water damage, cease using it immediately and unplug AC power.

MONITOR

Extremely high voltages exist in the monitor at all times. These high voltages exist even when the monitor is off and the AC line cord is disconnected. These voltages are extremely lethal and will cause death. The monitor contains no user serviceable parts. Do not attempt to service the monitor.

POWER SELECTOR

Before installing game, ensure the voltage on the PC is set properly. There is a 115/230 VAC selector switch that must be set for the correct voltage for your site. Verify the fluorescent lamp rating. The rating must match the line voltage at the installation site.

CONNECTORS

Ensure all connectors mate properly. If connectors do not slip in easily, do not force them. Connectors are often keyed and only connect one way. Check for correct orientation.

COMPUTER

The computer contains sensitive components, including a hard drive. Do not handle it roughly. Call your distributor before servicing its internal components. Ask about warranty information as it relates to the PC.

Do not turn the PC power switch on or off. It should remain permanently in the ON position.

Cycle AC power on or off with the cabinet power switch.

A dongle has been inserted into one of the USB ports. This is required for game play.

Do not remove the dongle except for troubleshooting purposes.

POWER CORD

If the power cord is damaged or lost, replace it with an identical cord as supplied by the manufacturer or an authorized service agent.

WATER JETS

Do not install or operate game within operating perimeter of a water jet. Do not clean equipment using water jet.

HAZARD TO EPILEPTICS

A small portion of the population has an epileptic condition that may cause seizures. Affected persons experience seizure while watching some television pictures or playing certain video games. People who have not had seizures may still have an undetected epileptic condition. If anyone in your family has experienced epilepsy symptoms (seizures or loss of awareness), consult your physical before using video games. While children play video games, a parent should observe. Be alert to the following symptoms: dizziness, altered vision, eye or muscle twitching, involuntary movements, loss of awareness, disorientation or convulsions. If you or your child experiences these symptoms, discontinue use immediately and consult your physician.

MANUAL

Keep this manual available and ready for use. If the game fails to function properly, turn off the machine and unplug the AC line cord. Contact your local distributor. Your warrantee, when applicable, lasts 60 days from your purchase date. You may not reproduce this document or any of its contents without written authorization from Raw Thrills™, Inc. or PlayMechanix™ Inc.

SPECIFICATIONS

For reasons such as performance, this product's specifications may change without notice. Federal patent, copyright and other intellectual property laws protect the content, devices and design of the game and its equipment.



Product Specifications

Electrical Power

Domestic 120 VAC @ 60 Hz, 5 amps
International 240 VAC @ 50 Hz, 2.5 amps
Japan 100 VAC @ 50 Hz, 5 amps

DC Power Fuse Guide

+5 VDC - 2 amp Slow Blow +12 VDC - 7 amp Slow Blow

Temperature

32° to 100° Fahrenheit (0° to 38° Celsius)

Humidity

Must not exceed 95% relative humidity

Panorama Cabinet Dimensions

Height - 86" Width - 31.5" Depth - 51.694" *

*Dimensions do not account for varying screen dimensions

***Monitor weight does not exceed 120 lbs**

Panorama Carton Specifications

Weight: 287 lbs

Height - 41" Width - 31.5" Depth - 51.694"

32" Dedicated Cabinet Dimensions

Height - 78.5" Width - 32.5" Depth - 32"

32" Dedicated Carton Specifications

Weight: 350 lbs

Height - 80" Width - 35" Depth - 35"

42" Dedicated Cabinet Dimensions

TBD

42" Dedicated Carton Specifications

TBD



*Panorama Cabinet
with Operator
supplied monitor*

32" Dedicated Cabinet

*42" Dedicated Cabinet not pictured

Setup

Panorama Cabinet Setup

Unpack Carton

1. Place the shipping crate on a flat stable surface.
2. Cut the banding straps and remove the cardboard lid.
3. Lift off the large cardboard container surrounding the cabinet and any shipping cleats.
4. Remove the two steel monitor stanchions.
5. Remove both guns from the carton situated on top of cabinet pedestal.
6. Place the guns in holsters on cabinet bezel.
7. Remove carton containing mounting bracket assembly and marquee assembly.
8. With at least two people and a dolly, remove the cabinet from the shipping pallet.
9. Remove the coin door key from the coin return chute.
10. Open the top coin door.
11. Locate the key for the back door and the cash box.
12. Remove the items inside cash box: AC power cable, a bag of screws and tools, marquee power cable, this manual, registration packet, and cell antenna mount

Verify Contents

Verify you have received the following contents.

- (1) Big Buck HD® marquee
 - (1) Marquee Power Cable
 - (2) Monitor Stanchion
 - (1) Mounting Bracket
 - (1) AC Power Cable
 - (1) Cell Antenna mount
 - (1) Parts Bag Containing:
 - (4) ¼-20 x 3.5" flat-head bolts
 - (4) ¼-20 x 3" Hex bolts
 - (8) ¼-20 elastic stop nuts
 - (1) HDMI Cable*
 - (1) Mounting Screw Bag *
- *Not pictured



NOT INCLUDED:

- **Monitor**



Purchase a Monitor

Monitor selection is vital to game performance. This is due not only to visual quality but more importantly due to input latency. A high input latency can cause a noticeable delay between a player's input and its effect onscreen. It is advisable to avoid using low end models or older models. They may be cheaper, but the price can come at a cost in performance. Similarly, high end models may have additional features that negatively impact input latency. Look for a display built with gaming in mind, such as those with a game mode setting. Consult with the manufacturer and/or vendor to find a suitable low input latency monitor. Consult monitor manual and/or manufacturer to setup and configure display for low input latency.

At minimum, monitor should be a 1080p flat panel ranging from 42" to 55" with HDMI input.

It is strongly recommended to use a display with a game mode.

Note – Not all monitors have GAME MODE. Refer to monitor manual for confirmation.

Note – Not all monitors with GAME MODE have acceptable input latency.

Requirements

- 1080p
- HDMI input
- Monitor weight does not exceed 120 lbs

A list of approved monitors can be found at <http://rawthrills.com/>

Consult your distributor for further assistance in finding an acceptable monitor.

Mounting Screws

As VESA mount point thread sizes vary from monitor to monitor, you will need 4 of these screws, if your selected monitor does not include them.

A selection of the most commonly sized mounting screws has been included.

- **(4) 6MM X 16MM machine screws**
- **(4) 6MM X 30MM machine screws**
- **(4) 8MM-1.25 X 16MM machine screws**
- **(4) 8MM-1.25 X 30MM machine screws**

Service Manual

Setup

Setup Cabinet Pedestal

1. Using a wheeled cart and at least one assistant, transport the cabinet to a suitable playing area.

Proximity to Neon Lights

Neon lights may reduce the ability of the IR sensors to accurately track the guns. Place the cabinet far away from neon lights or turn off any nearby neon lights.

2. Ensure the game cabinet is level and stable.
With at least one assistant, adjust the leg levelers.
3. Check the AC line cord for visible signs of damage.
Pay particular attention to the plug and line cord insulation.
4. Check for shipping damage to the following:
 - Gun assembly: Left and right guns, gun holders, and cables
 - Cabinet Marquee
 - Cabinet back door
 - Cabinet coin door
 - Cabinet and gun decals

Setup Monitor Stanchions

1. Place the stanchions in each of the mounting voids with cabinet-bolt holes at the bottom. Center hole should be facing inside of cabinet as pictured.
2. Facing the back of the game, route Marquee power cable through right stanchion. 6-pin connector should remain at top. Locate and connect trio of connectors at the bottom.

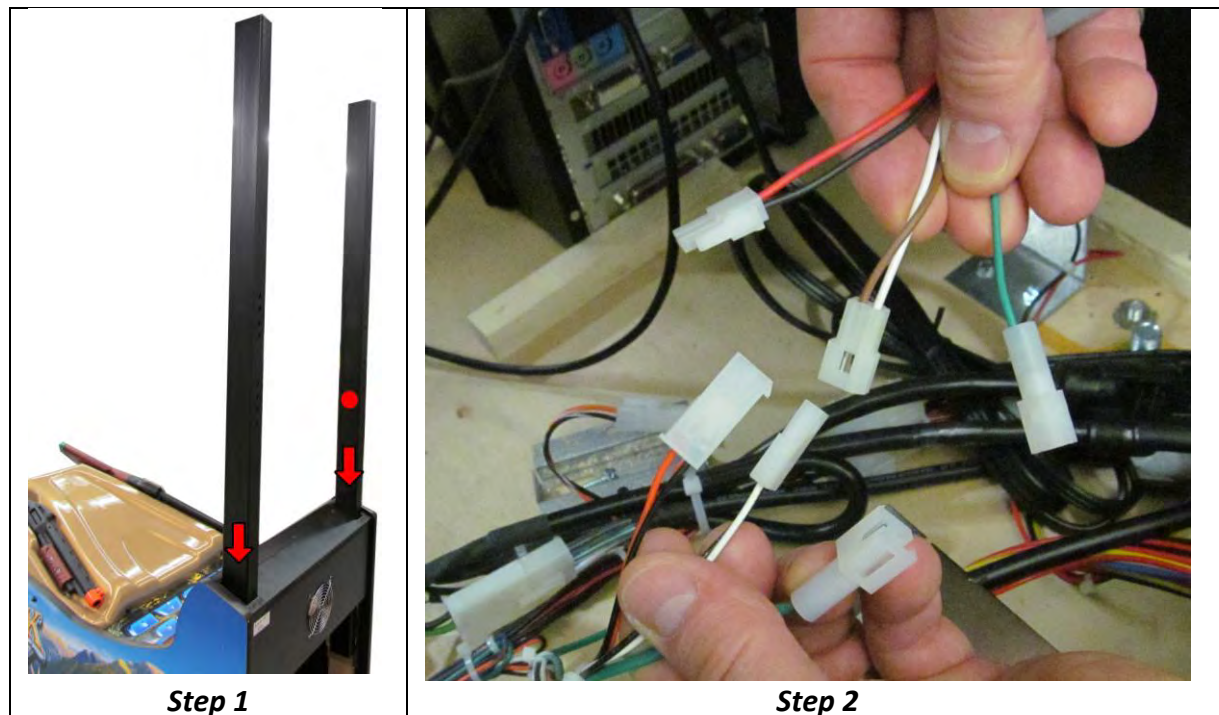



3. Connect HDMI cable to PC and connect monitor power cable inside cabinet.
4. Route the monitor HDMI and monitor power cables through the left stanchion tube. Start routing at bottom of stanchion. Route cables to midpoint opening with 12" slack exposed.
**Note: Some monitor power cables are fixed to the monitor. In such a case, cable must be routed through stanchion after hanging monitor.*



5. Locate hardware bag provided in the marquee box.
6. Using (4) ¼-20 x 3.5" flat-head bolts and (4) ¼-20 elastic stop nuts, secure stanchions.

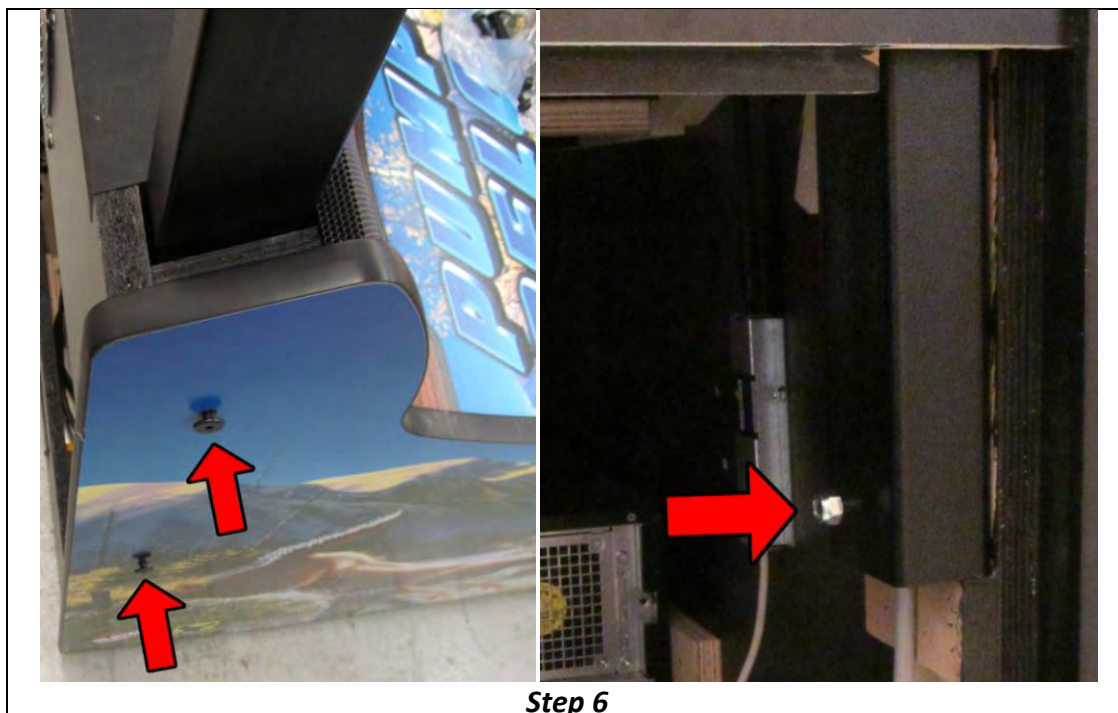

Attach Mounting Bracket to Stanchions

1. Locate Mounting Bracket in the marquee box.
2. Position mounting bracket to use 3rd hole set from the top of the stanchions.
3. Slide (4) ¼-20 x 3" hex bolts into mounting bracket from rear of stanchions.
4. Secure bolts with (4) ¼-20 elastic stop nuts at the front of the stanchions.

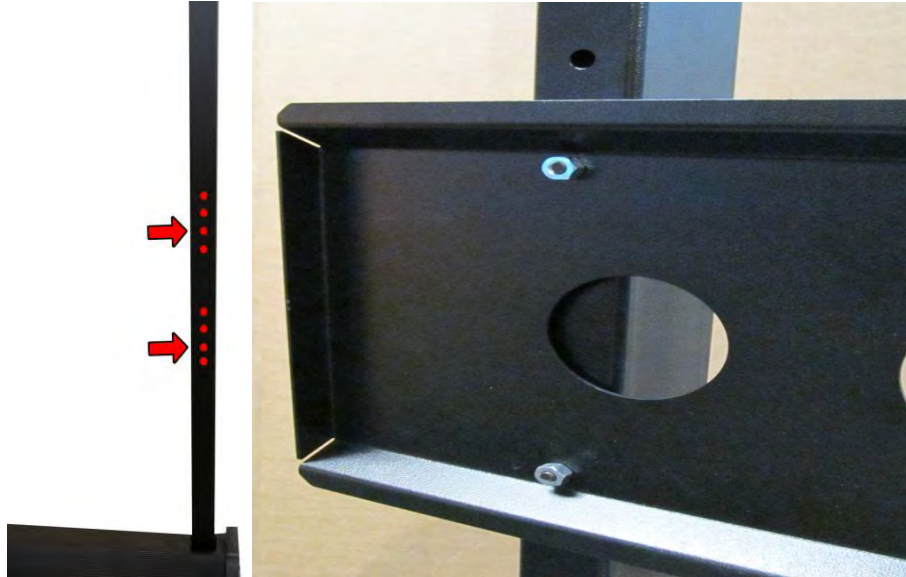

Mounting Bracket as seen from front of cabinet

Attach Monitor Mounts

1. Locate monitor mounts in the marquee box.
2. Locate VESA mount holes on the back of your selected monitor.
3. Position mounts in line with VESA mount holes.
Make sure to center the mounts vertically within the height of your monitor.
4. Fasten the monitor mounts to the back of the monitor.

As VESA mount point thread sizes vary from monitor to monitor, be sure to use the correct size of screws from the included assortment, if they are not provided by your selected monitor.

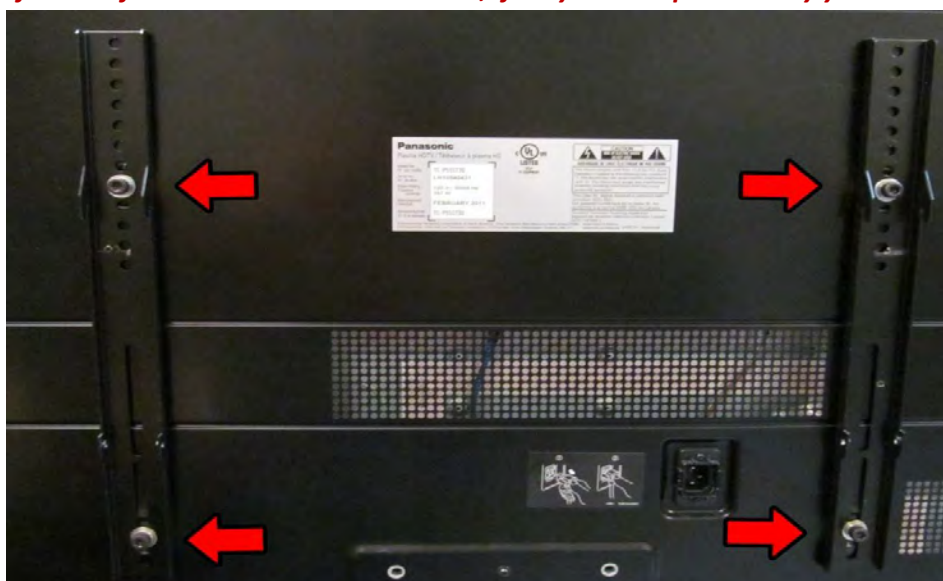



Attach Monitor to Mounting Bracket

1. With at least one assistant, raise monitor above cabinet pedestal.
2. Slide monitor on to mounting bracket.
3. Connect monitor power cable to monitor
4. Connect hdmi cable to monitor



Setup Marquee Assembly

1. Remove marquee assembly from box.
2. With at least one assistant, raise marquee assembly above stanchions.
3. Slide marquee down onto stanchions.
Be careful not to pinch cables.
4. Route IR and marquee cables through marquee mounts.
5. Rest marquee on top of monitor.
6. Adjust horizontal position of monitor. Marquee tab should be centered within monitor face.
7. Adjust depth of marquee. Be sure centering tab overlaps front of monitor.
Marquee tab should be flush against monitor face.
8. Secure marquee depth and height by tightening (4) marquee bolts.



Step 6 and 7



Step 8

Service Manual

Setup

9. Connect IR marquee 6-pin connector at top of stanchion.



10. Verify monitor is centered relative to marquee by sliding monitor left or right. Centering monitor is critical for gun calibration and performance.
11. Secure monitor to bracket by tightening the set screws on the monitor mounts.





32" or 42" Dedicated Cabinet Setup

1. Place the shipping crate on a flat stable surface.
2. Cut the banding straps and remove the cardboard lid.
3. Lift off the large cardboard container surrounding the cabinet and any shipping cleats.
4. With at least two people and a dolly, remove the cabinet from the shipping pallet.
5. Remove the coin door key from the coin return chute.
6. Open the top coin door.
7. Locate the key for the back door and the cash box.
8. Remove the items inside cash box: AC line cord, a bag of screws and tools, and a warranty card.
9. Using a wheeled cart and at least one assistant, transport the cabinet to a suitable playing area.

Proximity to Neon Lights

Neon lights may reduce the ability of the IR sensors to accurately track the guns.

Place the cabinet far away from neon lights or turn off any nearby neon lights.

10. Remove packing material from the guns.
11. Ensure the game cabinet is level and stable.
With at least one assistant, adjust the leg levelers.
12. Check the AC line cord for visible signs of damage.
Pay particular attention to the plug and line cord insulation.
13. Check for shipping damage to the following:
 - Gun assembly: Left and right guns, gun holders, and cable
 - Cabinet glass: Marquee and monitor
 - Cabinet back door
 - Cabinet coin door
 - Cabinet and gun decals

Verify Cabinet Functionality

1. Verify the voltage in the nearest AC outlet.
2. Verify the AC outlet ground connection is present and working.
3. Open the back door of the cabinet.
4. Near the AC power transformer, verify the voltage selector switch is set for the correct AC voltage.
5. Remove the marquee front plate.
6. Verify the fluorescent fixture in the marquee is set for the correct voltage.
7. Replace the marquee front plate
8. Plug the line cord into the AC outlet.
9. Replace the back door.
10. Turn the power switch to ON.
11. Verify that the cooling fans on the cabinet are working.
If not, turn off AC power and disconnect line cord. Contact Betson service
12. Check that no component is excessively hot or emitting foul odors.
If so, turn off AC power and disconnect line cord. Contact Betson service.
13. Once software loads, you will be asked to setup the cabinet software.

Big Buck HD® Setup Wizard



The Big Buck HD® Setup Wizard provides a step-by-step setup procedure.

Gun Calibration

Panorama Cabinet

1. Pull the trigger on the left gun to indicate that it is Player 1.
2. Stand directly in front of the gun pedestal; aim at the dot above the screen and shoot.
3. Continue to aim and shoot targets as instructed.
4. The targeting reticle indicates the spot where the gun is aimed.
Verify accuracy by pointing at different areas of the screen.
5. Accept calibration by pressing start button.
6. Repeat steps 2-5 for right gun.
7. Press Start button when finished.

32" and 42" Dedicated Cabinets

1. Pull the trigger on the left gun to indicate that it is Player 1.
2. Stand directly in front of the gun pedestal; aim at the dot center screen and shoot.
3. The targeting reticle indicates the spot where the gun is aimed.
Verify accuracy by pointing at different areas of the screen.
4. Accept calibration by pressing start button.
5. Repeat steps 2-4 for right gun.
6. Press Start button when finished.



Monitor Latency Test



Only part of Setup Wizard for Panorama Cabinets

1. Press start button to begin test
2. Watch the demo video or press test to skip.
3. Aim down the site and move gun left and right across the screen.
4. Determine monitor latency level.
If reticle stays in the **GREEN** zone while moving left/right, monitor has acceptable latency.
If reticle enters a **RED** zone, monitor has unacceptable latency.
5. Press test when done.

Consult distributor, monitor manual, and/or manufacturer for settings to help reduce latency.

Color & Brightness

Adjust color, contrast, brightness and other monitor settings for best picture quality.

Operator Registration

1. If you already have an existing account, login with your Operator id and pin.
2. To register as a new operator, follow the step-by-step instruction to create an account.

Cabinet Registration

Select or setup a location for the cabinet. This will provide tracking/management functionality through coinup.com. It will also allow players to locate the game through bigbuckhd.com.

Connectivity Wizard

Accept cell contract or reconfigure connection.

Verify Input and Output Functionality

See the Diagnostic Section for further information.

1. Enter the SWITCH TEST menu and verify all switches function.
2. Enter the SCREEN TEST menu and verify that video is acceptable.
3. Enter the SOUND TEST menu and verify the audio works and is not distorted.
4. Enter the COIN METER TEST and verify the operation of the coin meter.
5. Enter the START BUTTON LAMPS menu and verify that the lamps of the buttons work correctly.
6. Enter the WATCHDOG TEST menu, which re-boots the game.
7. Upon a successful re-boot, you are ready to make adjustments to pricing, volume and other functions found in the Diagnostic Section.

Verify Cabinet Connectivity

See Diagnostic Section for further information

1. Select ONLINE and run test connection
2. If any of the tests result in FAILURE, consult troubleshooting section.
3. Return to ONLINE and enter Cellular Information.
4. If connection is not optimal, consult connectivity guide.



Maintenance

Regular Gun Maintenance Procedure

Big Buck HD® is equipped with two state-of-the-art custom-designed gun controllers. In order to maximize income potential, keep the guns in optimal working order by performing the following five-step procedure every time you empty the cash box.

- 1. Check the camera lens**
Observe the tinted lens at the tip of the gun to ensure it has no cracks, scratches or dirt. Clean or replace the lens, if necessary.
- 2. Visually and manually inspect gun cable connections**
Open the coin door to see them. Reach in and ensure the cables are fully connected and are not pinched by any components.
- 3. Verify switch functionality**
Press the Test button on the service panel, select Tests, select Input Tests, and then select Switch Test (described earlier in this manual) to ensure all the gun switches are functioning properly. Switches in the gun include
 - Trigger
 - Pump
- 4. Calibrate, calibrate, calibrate**
Return to the Main Menu screen and select Gun Calibration. Follow the instructions earlier in this manual or on screen to recalibrate both guns.
- 5. Check IR sensors**
The IR sensors are directly below and above the printed marquee on the monitor assembly. From the Main Menu, select Tests, select Input Tests, and select IR Gun Sensor Test. See pg 20

Recalibrate the guns any time the game is moved or the guns are repaired, replaced or swapped.

Note: It is not advisable to replace or swap guns while power is on. Shut AC power off before connecting or disconnecting any components. If, for some reason, guns are changed while power is on, shut off AC power and reboot after the guns are connected again. Failure to do so may confuse the system so it does not recognize the guns.

**Following These Procedures Is Critical To
Maintaining Guns and Maximizing Revenue.
Perform regular gun maintenance to keep your
game in top working order.**

Hard Drive Recovery

Hard Drive Recovery is used to update your game with new software or return the game to factory

Symptoms requiring hard drive recovery include:

- File Test reports bad or missing files
- Game fails to finish loading during startup
- After resetting the AC power, an error is reported
- You are prompted to insert a boot DVD
- Erratic Game or Attract Mode
- The following screen:



COMPUTER

The computer contains sensitive components, including a hard drive. Do not handle roughly. Call your distributor before servicing its internal components. Ask about warranty information as it relates to the PC.

Do **not** use the PC on/off switch. Turn AC power on or off with the cabinet power switch.

1. With game and PC on, insert recovery DVD, marked as Disc 1, into DVD-ROM drive tray.
2. Close tray and Turn cabinet AC power switch to OFF.
3. **Disconnect all USB devices from the PC.**
4. Wait 30 seconds, then turn AC power switch to ON. Recovery begins automatically.
If recovery fails to begin, check that disc is seated properly in DVD-ROM drive tray.
5. Initial software loading may take several minutes. Check progress periodically.
Do not interrupt power or reset the game during recovery.
6. At some point, the game will eject *Disc 1* and prompt you to insert *Disc 2*.
7. Swap discs and close the tray. **Do not interrupt power or reset the game.**
8. At some point, the game will eject *Disc 2* and prompt you to insert *Disc 3*.
9. Swap discs and close the tray. **Do not interrupt power or reset the game.**
10. When software has finished loading, a message indicates that restore is complete.
When instructed to remove *Disc 3*, open DVD-ROM drive tray and remove disk.
11. **Reconnect all USB devices.** Turn cabinet power switch off.
12. After 30 seconds, turn cabinet power switch on.
13. After game restarts, it will enter calibration mode. Re-calibrate guns.



14. Settings will now be factory defaults – make changes as desired.

Diagnostic Menu System

Diagnostic Menu Interface

The Service Panel should have four buttons. Pressing the TEST button at any point while the game is running will enter the diagnostic menu. This menu can be navigated with the service panel or the gun.

An on-screen message acknowledges changes or when you exit a selection without making a change.

At the bottom of each screen, there is a brief description of the highlighted menu option.

For clarity, all menu screens in this manual omit the header, background image, and control instructions.

Navigating with Service Panel Switches

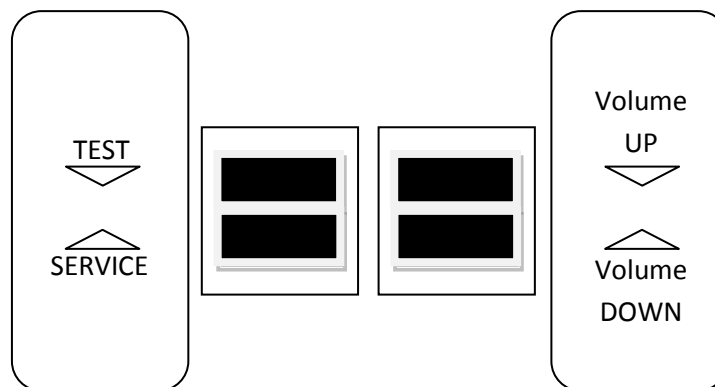

- TEST enters diagnostic system or select highlighted menu option
- SERVICE exit current menu
- VOLUME DOWN moves down through menu or setting choices
- VOLUME UP moves up through menu or setting choices

Navigating with Gun

- The menu interface can be navigated with the gun by aiming and shooting.
- Shooting the right side options will perform the indicated action.
- Shoot scroll up or scroll down to highlight menu options.
- Shoot select to enter the highlighted menu or perform the highlighted option.
- Shoot exit to return to the prior menu or exit the diagnostic system.

Menu Screens and Descriptions

Main Menu

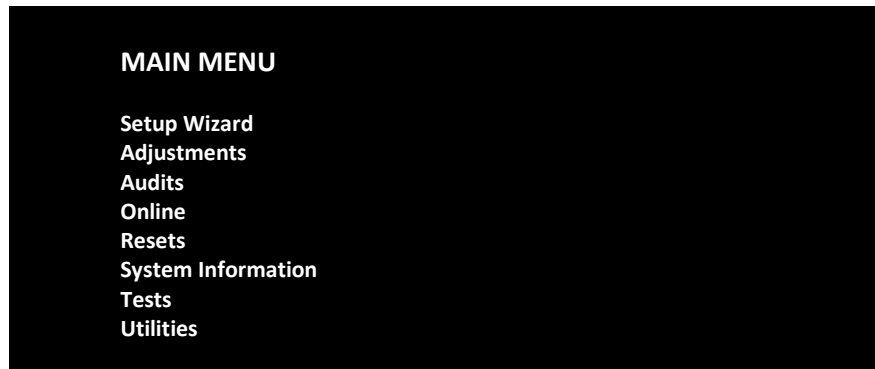

- **Setup Wizard** pg 14 - will only appear if setup wizard has not been completed
- **Adjustments** pg 20 - modify various game settings
- **Audits** pg 24 - view various tracking statistics
- **Online** pg 25 - setup and manage online functionality
- **Resets** pg 30 - used to restore game to factory defaults
- **Information** pg 30 - view various hardware and software information
- **Tests** pg 33 - execute various diagnostic and maintenance tests
- **Utilities** pg 36 - contains tools for managing game performance

Main Menu

Adjustments

These menus control gameplay, coinage and sound adjustments.

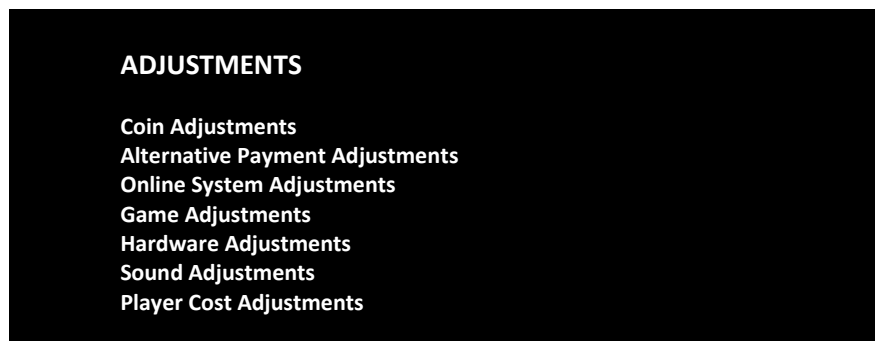

You can improve earnings by customizing performance with game adjustments. Each variable on an adjustment menu changes an aspect of game play or appearance. Optimizing these settings can maintain or increase player interest. Monitor the effects of adjustments by comparing audit information and earnings before and after changes.



Main Menu
Adjustments
Coin Adjustments

COIN ADJUSTMENTS	
Currency Type	Dollar
Coin Base Unit	\$0.25
Coin 1 Value	\$0.25
Coin 2 Value	\$0.25
DBV Pulse Value	\$0.25
Service Credit Value	\$0.25

Setting	Description	Default	Choices
Currency Type	Changing currency type resets coin door values. The denomination symbol changes on screen with each currency	Dollar	Yen, Won, Ruble, Real, Peso, Krona, Guilder, Franc, Can. Dollar, Coins, Euro, NZ Dollar, Rand, Pound, Aus. Dollar
Coin Base Unit	Changes the amount by which monetary values increment	\$0.25	\$0.25 - \$63.75 in \$0.01 increments
Coin 1 Value	Sets the coin slot pricing	\$0.25	\$0.25 - \$63.75 incrementing by coin base unit setting
Coin 2 Value	Sets the coin slot pricing	\$0.25	\$0.25 - \$63.75 incrementing by coin base unit setting
DBV Pulse Value	The bill validator (DBV) translates bills into electronic pulses. This setting determines how much game credit is awarded per pulse. With default setting of \$0.25, every \$1 bill will award \$1 in game credit. Set to \$0.50, every \$1 bill will award \$2 in game credit.	\$0.25	\$0.25 - \$63.75 incrementing by coin base unit setting
Service Credit Value	Set the amount of credit given by the service button	\$0.25	\$0.25 - \$63.75 incrementing by coin base unit setting

DBV PULSE VALUE

DBV must be set to award four pulses per dollar. Consult DBV for dipswitch settings or programming instructions.

Main Menu
Adjustments
Alternative Payment Adjustments

This menu allows control over accepting alternative payment.

ALTERNATIVE PAYMENT ADJUSTMENTS	
Cash Card	ON

Setting	Description	Default	Choices
Cash Card	Accept payment with cash cards	ON	ON/OFF

Service Manual

Diagnostic Menu System

Main Menu

Adjustments

Online System Adjustments

ONLINE SYSTEM ADJUSTMENTS

Online Maintenance Hour 4:00 am-5:00 am
 DB Server Port Automatic
 File Server Port Automatic

Setting	Description	Default	Choices
Online Maintenance Hour	The 60-minute period during which online-enabled games contact the server to check for software updates and synchronize with the game database.	4:00 am - 5:00 am	24 hours in one hour increments
DB Server Port	Adjusts the ports used to connect to the DB server.	Automatic	Automatic, 21, 80, 443, 7686
File Serve Port	Adjusts the ports used to connect to the File server.	Automatic	Automatic, 21, 80, 443, 8080, 8686

Main Menu

Adjustments

Game Adjustments

GAME ADJUSTMENTS

Trail Guides On

Setting	Description	Default	Choices
Trail Guides	Toggles the appearance of the female trail guides	ON	ON/OFF

Main Menu

Adjustments

Hardware Adjustments

HARDWARE ADJUSTMENTS

Monitor Size On

Setting	Description	Default	Choices
Monitor Size	Changes the brightness of IR array LEDs to accommodate bigger screens	40-55"	Less than 40"/40-55"/56-65"/66-74"/75" or larger



Main Menu

Adjustments

Sound Adjustments

Outside of diagnostic mode, pressing the Service Panel Vol + and Vol – buttons will adjust settings depending on if operator is within game or attract mode.

SOUND ADJUSTMENTS	
Game Volume	50
Attract Volume	25
Attract Sound Frequency	Frequently

Setting	Description	Default	Choices
Game Volume	Modifies volume during game play	50	0-100
Attract Volume	Modifies volume during attract mode	25	0-100
Attract Sound Frequency	Determines how often attract mode music will be played	Frequently	Off, Occasionally, Frequently, or Always

Main Menu

Adjustments

Player Cost Adjustments

PLAYER COST ADJUSTMENTS	
Freeplay	OFF
Trek Cost	\$1.00
Adventure Cost	\$3.00
Bonus-Only Cost	\$1.00
Showdown Cost	\$2.00

Setting	Description	Default	Choices
Freeplay	Allows play without money	OFF	OFF / ON
Trek Cost	5 sites and one bonus game	\$1.00	\$0.00 - \$63.75 incrementing by coin base unit setting
Adventure Cost	15 sites and three bonus games	\$3.00	\$0.00 - \$63.75 incrementing by coin base unit setting
Bonus-Only Cost	Four bonus games	\$1.00	\$0.00 - \$63.75 incrementing by coin base unit setting
Showdown Cost	Networked head to head game over 2 treks	\$2.00	\$0.00 - \$63.75 incrementing by coin base unit setting

Main Menu

Audits

Audit screens help assess game performance, find intermittent problems, decide whether to adjust game difficulty and free game award and help maximize game earnings.

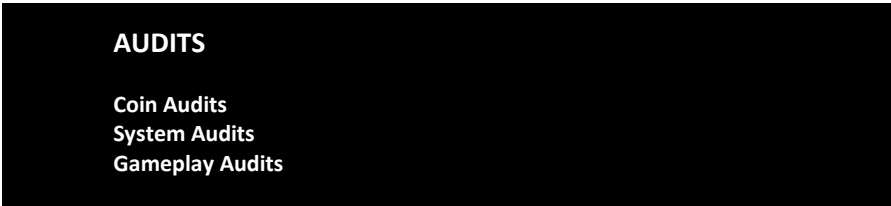

Main Menu

Audits

Coin Audits

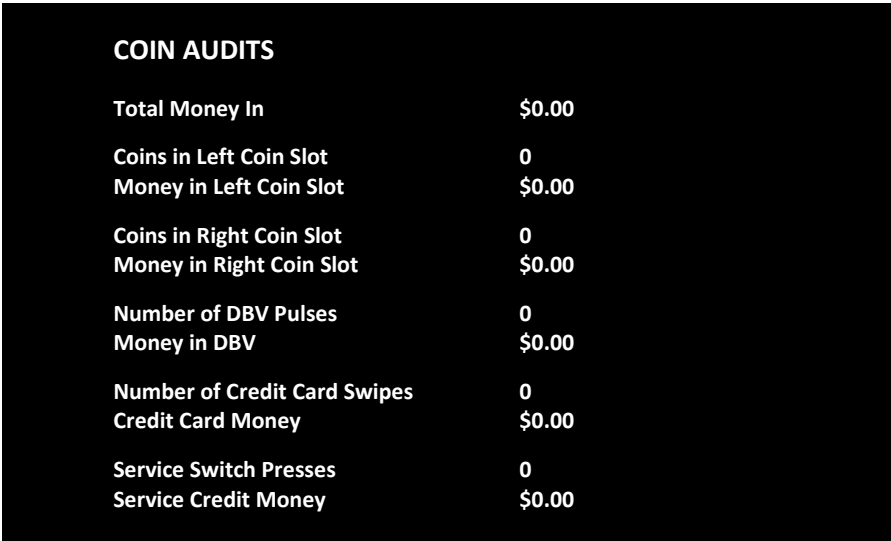

Main Menu

Audits

System Audits

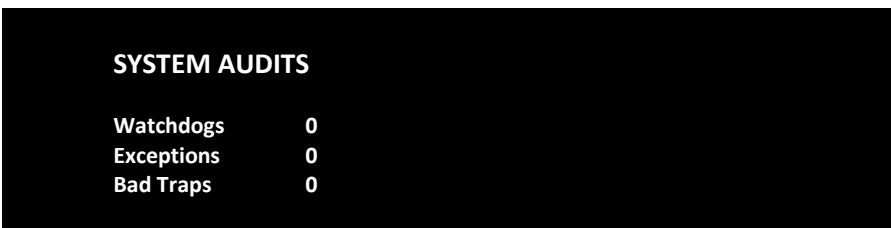



- Main Menu
- Audits
- Game Audits

GAME AUDITS			
1-Player Turn-Based Games	Total: 0,	1-Trek: 0,	3-Trek: 0
2-Player Turn-Based Games	Total: 0,	1-Trek: 0,	3-Trek: 0
3-Player Turn-Based Games	Total: 0,	1-Trek: 0,	3-Trek: 0
4-Player Turn-Based Games	Total: 0,	1-Trek: 0,	3-Trek: 0
Shootout Games	Total: 0,	1-Trek: 0,	3-Trek: 0
Showdown Games	0		
Total Player Starts	0		
Total Player Continues	0		
Total Continues Offered	0		

- Main Menu
- Online

These menus cover all online interaction with CoinUp®.

ONLINE
Connection Details and Test
Cellular Information
Wi-Fi Information
Online Synchronization
Connection Wizard
Cabinet Location/Registration
Software Update
Online Debug

- Main Menu
- Online
- Connection Details and Test

Use the Test Connection button to refresh the ping results.

CONNECTION DETAILS AND TEST			
Connection Interface	Wired (Ethernet)	eth0	00:18:d3:ff:c2:d6
Connection IP Info	10.0.1.2	255.255.255.0	10.0.1.1
Server Info	games.playmechanix.net	67.217.33.153	80
File Server Info	files.playmechanix.net	67.217.33.153	443
Test Results			
Server Ping	0	ms	Success
Database Ping	295	ms	Success
File Server Ping	840	ms	Success
Queued Messages	0		
Last Successful DB Query	04.05.2012 10:57:13	Last Successful FS Transfer	04.05.2012 10:57:13
Last Successful DB Query	04.05.2012 10:58:13	Last Successful FS Connection	04.05.2012 10:57:13
Last Failed DB Query	Never	Last Failed FS Connection	Never

Main Menu

Online

Cellular Information

Cellular Information provides all relevant information if a cell modem is being used.

CELLULAR INFORMATION	
Device Model	Not Found
Service Provider	N/A
ESN	N/A
Mobile Number	N/A
Mobile Line	Unknown
Connection Status	Not Connected
Roaming	No
Signal Strength	Bar Graph (0.0dBm)

Main Menu

Online

WI-FI Information

Wi-Fi Information provides all relevant information if a wireless device is being used.

WI-FI INFORMATION	
Adapter Model	Not Found
Adapter MAC Address	N/A
SSID	N/A
Connection Status	Not Connected
Access Point MAC Address	N/A
Signal Strength	Bar Graph

Main Menu

Online

Online Synchronization

This option executes synchronization with the online database. It will try to update the system clock, game registration, advertisements, tournaments, and other online features. This synchronization is also executed when the game is rebooted. Use this option to force any changes that have been made via coinup.com.

Main Menu

Online

Connection Wizard

The Connection Wizard is a step by step setup process for selecting and configuring the game's internet connection.



Main Menu

Online

Cabinet Location/Registration

This option displays current registration status for the machine. It allows the operator to register the machine to a location or change the registered location of the game. Game registration allows a variety of helpful interactions with coinup.com and online gameplay.

Main Menu

Online

Software Update

This option contacts database and file servers to check for new software updates.

Main Menu

Online

Online Debug

ONLINE DEBUG

- Tournament Information
- Add-on Tourney Information
- Add-on Tourney Template Info
- Advertisement Info
- View Online Permissions
- Server Details
- Certificate Details
- Activate Cell Modem
- Purge Query Cache

Main Menu

Online

Online Debug

Tournament Information

Displays various information regarding any classic tournaments assigned to the machine.

TOURNAMENT INFORMATION

Count Total – 0 – Complete – 0 – Active 0

- Name
- Info
- Dates
- Ldrbds

Main Menu

Online

Online Debug

Add-on Tourney Information

This screen displays information for the machine's add-on tournaments.
 Tournament ID: Unique identifier combining Animal, date, and an incrementing number
 Adv: Identifier related to the animal
 Treks: Indicates how many treks are played
 Max: Indicates maximum number of entrants
 Buy: Indicates entry cost per entrant
 Lbd: Indicates current number of entrants
 Timestamp: Indicates the last time the tournament was updated

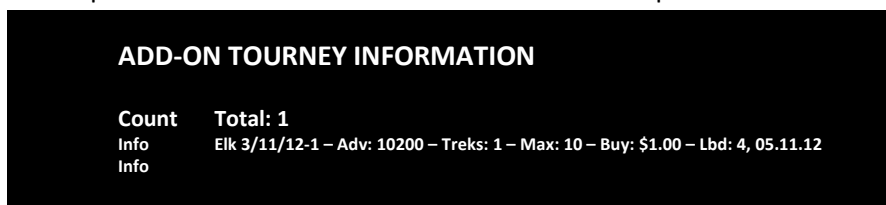

Main Menu

Online

Online Debug

Add-on Tourney Template Info

This page displays information regarding eligible add-on tournament types.



Main Menu

Online

Online Debug

Advertisement Info

This page displays information regarding downloaded advertisements.



Main Menu

Online

Online Debug

View Online Permissions

This page displays information regarding permitted online activity.

VIEW ONLINE PERMISSIONS	
Online:	ENABLED
Registered:	ENABLED
Full Connection:	ENABLED
Active Connection:	ENABLED
Credit Cards:	ENABLED
Add-on Tournaments:	ENABLED
Classic Tournaments:	ENABLED
Showdown:	ENABLED
Showdown Tournaments:	ENABLED
Trophy Club:	ENABLED
Buck Points:	ENABLED
Guest Login:	DISABLED
Quick Switch:	DISABLED

Main Menu

Online

Online Debug

Server Details

Displays server name, IP, and port for both database and file servers.

Main Menu

Online

Online Debug

Certificate Details

Displays the client's authorization certificate.

Main Menu

Online

Online Debug

Activate Cell Modem

Activates the cell modem line for use.

Main Menu

Online

Online Debug

Purge Query Cache

Purging the query cache will clear any online information stored locally forcing the game to pull down the most current information.



Main Menu

Resets

This menu allows for clearing of various settings and information.
Factory Reset clears everything and restores the machine to factory defaults.

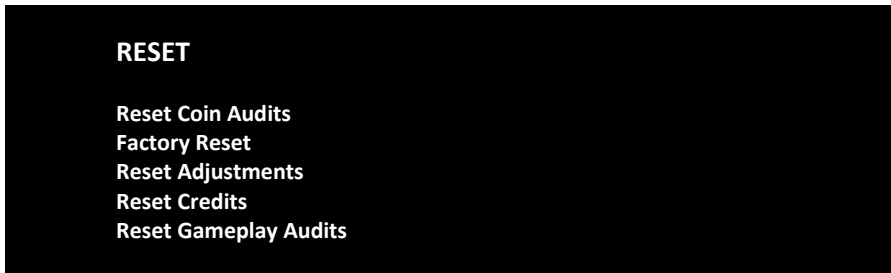

Main Menu

System Information

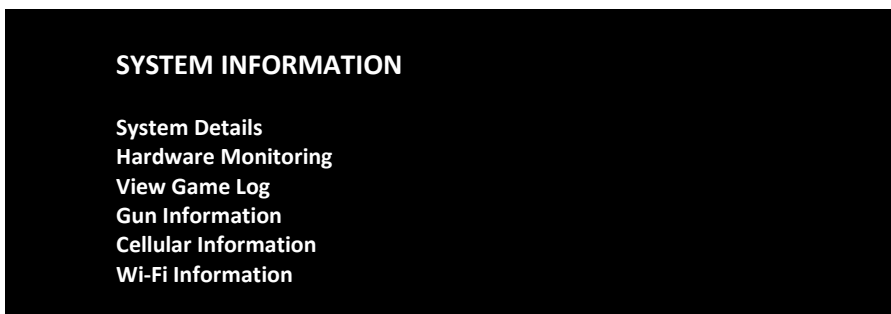



- Main Menu
- Information
- System Details**

SYSTEM DETAILS

BIOS	Vendor: Dell Inc. Version: A06	Date: 03/27/12
Kernel	2.6.39-jl2	
Processor	Intel® Celeron® CPU G530 @ 2.40GHz	
Memory	2051176 kb	
G5 Rev	27523	
Library Rev	1079	
Engine version	01.20.01	
I/O lib	01.01.05	
IR Track	03.02.35	
SDL	1.2.14	
Sound Lib	1.2.11	
RIO	HW: FFFC SW: 0.14	
Card Reader	1.6.3	
Game Version	1.29	

- Main Menu
- Information
- Hardware Monitoring**

HARDWARE MONITORING

System Uptime:	4 days, 07 hours, 39 minutes
Connection Audits Since:	7.27.2012 12:00:00
IO Board Connection:	Pass
IO Board Disconnects:	0
IO Board Last Disconnect:	
Left (Green) Gun Connection:	Pass
Left (Green) Gun Disconnects:	0
Left (Green) Gun Last Disconnect:	
Right (orange) Gun Connection:	Pass
Right (orange) Gun Disconnects:	0
Right (orange) Gun Last Disconnect:	
Card Reader Connection:	Pass
Card Reader Disconnects:	0
Card Reader Last Disconnect:	

Service Manual

Diagnostic Menu System

Main Menu
Information
View Log

This page displays any logged events or errors that occur during the game.

Main Menu
Information
Gun Information

GUN INFORMATION

Number of Attached Guns 2	Serial #'s
Left (Green) Gun Info:	Right(Orange) Gun Info:
Connected	Connected
Serial #	Serial #
Firmware Version	Firmware Version
Firmware Checksum	Firmware Checksum
Trigger	Trigger
Pump	Pump
Advanced Gun Info:	
Last LED Message # seconds	Last LED Message # seconds
Last Status Message # seconds	Last Status Message # seconds
Good Camera Frames (last 5 sec)	Good Camera Frames (last 5 sec)
Stuck Bits	Stuck Bits
N/A	N/A

Main Menu
Information
Cellular Information

See pg 26 – same screen as in Online Menu

Main Menu
Information
Wi-Fi Information

See pg 26 – same screen as in Online Menu



Main Menu
Tests

These various tests check cabinet and game functionality.
 They are divided into submenus for input and output tests.

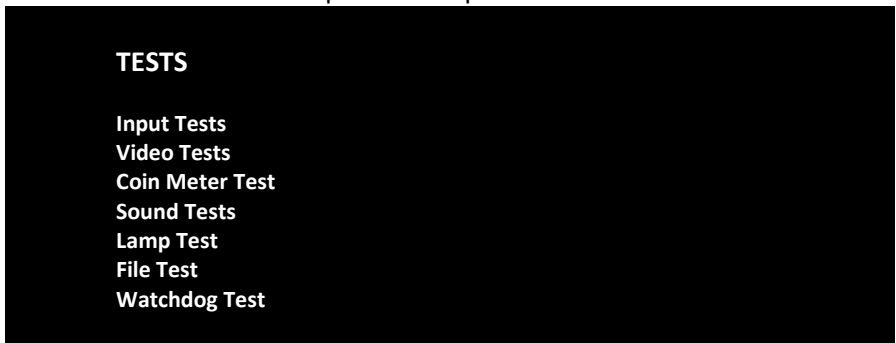

Main Menu
 Tests
Input Tests

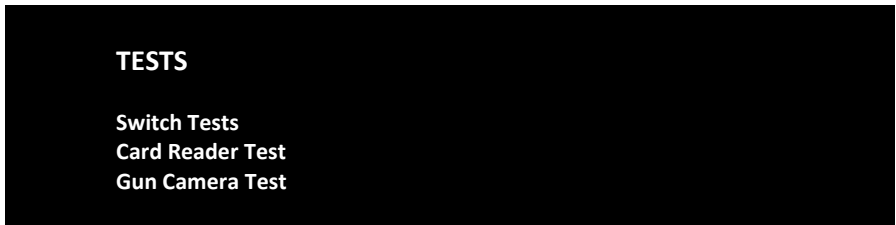

Main Menu
 Tests
 Input Tests
Switch Tests

This checks input switch performance. By default, all switches should indicate inactive.
 When a switch is pressed, it should indicate active and be highlighted on screen.

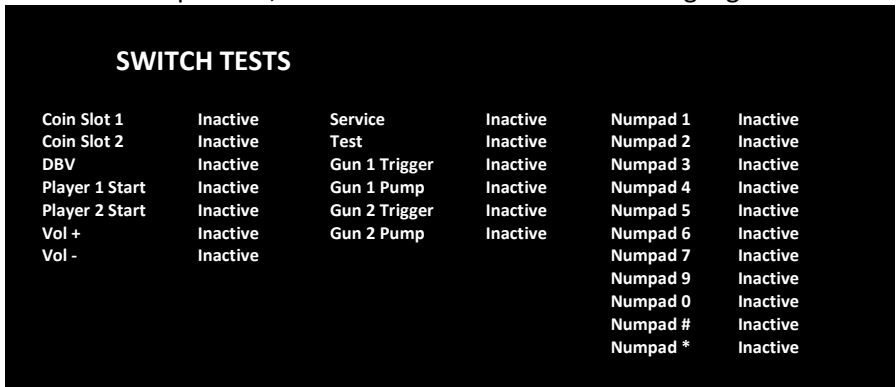

The Switch Test menu has a unique exit procedure, because it checks the switches normally used for navigation. To exit the switch test menu, press the test button five times.

Main Menu
Tests
Input Tests
Card Reader Test

On swipe, card reader should read the card type and indicate success/failure for track 1 & 2. If results indicate failure, that card might be worn. If results indicate failure across several cards, card reader might be faulty.

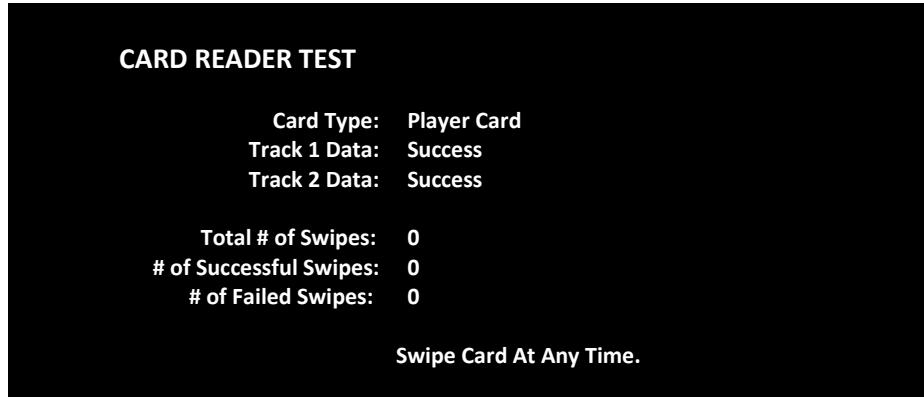

Main Menu
Tests
Input Tests
Gun Camera Test

This test displays the IR array information as interpreted by the gun's camera. This will be displayed onscreen as two rows of dots. If these dots do not display, there may be a problem with the camera or IR array boards. If any grouping of dots is not present or flickers, IR board should be replaced.

Main Menu
Tests
Video Tests

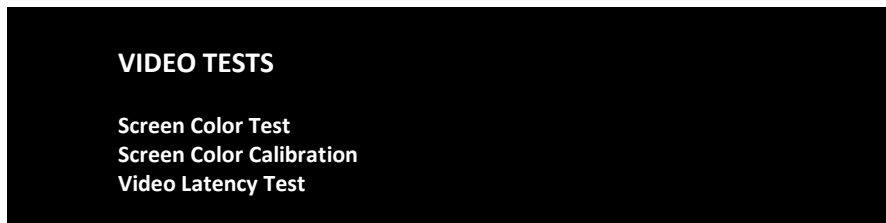



Main Menu

Tests

Video Tests

Screen Color Test

Screen Color test provides a full screen of a solid color. Press start button to cycle colors.

Main Menu

Tests

Video Tests

Screen Color Calibration

Screen test provides a static picture and color bars to assist in adjusting monitor settings.

Main Menu

Tests

Video Tests

Video Latency Test

This test checks the video response time of the display.

Main Menu

Tests

Coin Meter Test

Press a start button to increment the coin meter.

Main Menu

Tests

Sound Tests

This checks sound volume and quality. Missing sounds indicated digital flaws. Distorted sounds suggest analog flaws. Lack of sound suggests disconnected or bad cables or speakers.

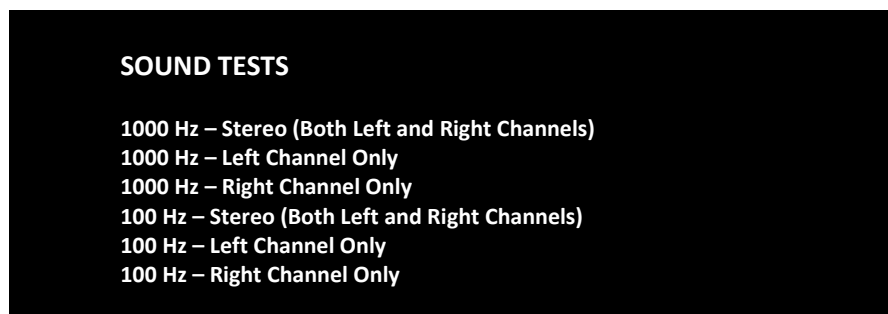

100 and 1000 Hz tests generate specific frequency sounds on the indicated channel. Cancel these sounds by selecting another test or exiting the menu.

Service Manual

Diagnostic Menu System

Main Menu

Tests

Lamp Test

This test checks for burned-out start button lamps. Test lights left, right, then both buttons.

Main Menu

Tests

File Test

This tests the integrity of the contents of the hard drive, searching for corrupt or missing game files. Damaged or missing files register as failed and are listed. The only solution to this problem is to restore the system from the DVD-ROM, as described in the Restore the Hard Drive section.

Main Menu

Tests

Watchdog Test

This tests the Watchdog circuit, which protects the game against screen freezes (infinite loops). After a countdown, the game resets. To exit before the reset, press either Start or Volume button, squeeze a trigger or pump a gun. If the test succeeds, the game resets normally. If the test fails, the reset process loops or ends abnormally. See the Troubleshooting Chapter to diagnose and correct this problem.

Main Menu

Utilities

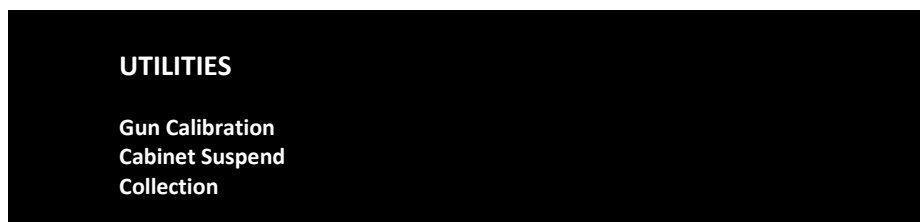

Main Menu

Utilities

Gun Calibration

This is the same procedure described earlier in the Gun Calibration section pg14.

Main Menu

Utilities

Cabinet Suspend

This option toggles a suspended state for maintenance to avoid online service changes.



- Main Menu
- Utilities
- Collection**

COLLECTION

- Take Collection
- View Cash Card Details
- View Player Account Details
- View Service Credit Details
- View Credit Card Fee Details
- View Coinup Service Details

- Main Menu
- Utilities
- Collection
- Take Collection**

TAKE COLLECTION

Date of Last Collection:	01.10.2012 (0.0 days)	
Gross Collection		\$0.00
Cash	\$0.00	
Cash Card	\$0.00	
Credit Card	\$0.00	
Player Account	\$0.00	
Service Credits	\$0.00	
<u>Balance (Cash Card not included)</u>		<u>\$0.00</u>
Credit Card Fees		- \$0.00
CoinUp Fees		- \$0.00
<u>Net Collection</u>		<u>\$0.00</u>
Operator Split	(50.0%)	\$0.00
Location Split	(50.0%)	\$0.00

Send Collections Message contacts the server and delivers the latest collections information. Operator and location splits can be adjusted.

Main Menu
Utilities
Collections
View Cash Card Details

VIEW CASH CARD DETAILS	
Turn Based Play	\$0.00
Shootout Play	\$0.00
Bonus Only Play	\$0.00
Add On Trny Fees	\$0.00
National Trny Play	\$0.00
National Trny Funding	\$0.00
Custom Trny Play	\$0.00
Custom Trny Funding	\$0.00
Showdown Play	\$0.00
<u>Showdown Trny Fees</u>	<u>\$0.00</u>
Total Cash Card Usage	\$0.00

Main Menu
Utilities
Collections
View Player Account Details

VIEW PLAYER ACCOUNT DETAILS	
Turn Based Play	\$0.00
Shootout Play	\$0.00
Bonus Only Play	\$0.00
Add On Trny Fees	\$0.00
National Trny Play	\$0.00
National Trny Funding	\$0.00
Custom Trny Play	\$0.00
Custom Trny Funding	\$0.00
Showdown Play	\$0.00
<u>Showdown Trny Fees</u>	<u>\$0.00</u>
Total Player Account Usage	\$0.00



Main Menu
Utilities
Collections
View Service Credit Details

VIEW SERVICE CREDIT DETAILS	
Turn Based Play	\$0.00
Shootout Play	\$0.00
Bonus Only Play	\$0.00
Add On Trny Fees	\$0.00
National Trny Play	\$0.00
National Trny Funding	\$0.00
Custom Trny Play	\$0.00
Custom Trny Funding	\$0.00
Showdown Play	\$0.00
<u>Showdown Trny Fees</u>	<u>\$0.00</u>
Total Player Account Usage	\$0.00

Main Menu
Utilities
Collections
View Credit Card Details

VIEW CREDIT CARD DETAILS	
Attempted Credit Transactions	0
Successful Credit Transaction	0
<u>Total Charged</u>	<u>\$0.00</u>
Transaction Fees	\$0.00

Main Menu
Utilities
Collections
View Coinup Service Details

VIEW COINUP FEE DETAILS		
Online Subscription Service	(0.0 days)	\$0.00
Cell Modem Charge	(0.0 days)	\$0.00
Add On Trny Funding		\$0.00
Showdown Trny Funding		\$0.00
National Trny Funding		\$0.00
Operations Charge	(0.0 days)	\$0.00
<u>Custom Trny Funding</u>		<u>\$0.00</u>
Total Coinup Service		\$0.00

CoinUp®

Operation Overview

Having your game connected to CoinUp® allows easy access to software updates and permits game health and earnings to be monitored via coinup.com.

There are three ways to connect: wired, cellular, or wireless.

Operator Registration

New operators may register directly at the game. Simply follow the steps during the Setup Wizard.

You will need a valid credit card to complete registration. Card will be charged \$0.01; this charge is immediately voided and will not appear on your monthly statement.

Be sure to note your assigned operator id number and your pin. These numbers distinguish operators and are used to login to the game during unit registration.

Alternatively, complete the following steps.

1. Open a bank debit account.
2. Complete CoinUp® Operator Registration Packet.
 - Fill out the CoinUp® *Authorization Agreement for Automated Payments*.
 - Read and sign the CoinUp® *Participating Operator Agreement*.
 - Read and sign the CoinUp® *Operator Registration Form*.
3. To become an authorized operator, fax the forms to (630) 348-2099 or mail them to:
Play Mechanix™
800 Roosevelt Road, Suite D-103
Glen Ellyn, IL 60137
Authorization occurs in just a few days. Login information will be sent via email.

Unit Registration

During the setup wizard, you will be prompted to register the game. This links the game to the operator and ties it to a specific location. Unit registration permits monitoring and management via coinup.com. Follow the on-screen prompt to login and add/select a location to complete registration.

Access CoinUp® Operator Center

The CoinUp® Operator Center tracks the performance of your games. For example, you can compare performance of different machines at the same location, or even across locations. To access CoinUp® and view your pages, follow the steps below. From there, the site provides guidance. You follow easy prompts and navigate to the statistic, accounting, bookkeeping or performance data that you need.

1. Access the CoinUp® Web site at www.coinup.com.
2. Enter the account e-mail address and password to login.
3. (Optional) To change login information, use the Profile tab.
4. Select locations or products to view.

FCC Compliance You are solely responsible for FCC compliance on installations.



Network Configurations

Wired Connection – Ethernet Cable

1. Set up DSL or cable modem service through an ISP.
2. Turn off AC power, unplug the power cord, and open the back door.
3. Run the Ethernet cable to the cabinet.
4. Route the Ethernet cable through the mouse hole in the back door.
5. Inside the cabinet, dress the Ethernet cable away from other cables and metallic parts.
6. Connect the Ethernet cable to the RJ45 jack on the PC.
7. Close the back door.
8. Plug in power cord and turn on AC power.

Cellular Connection - Cell Modem

A cell modem and antenna comes preinstalled and preconfigured with the cabinet. The antenna is located beneath cabinet bezel. *However, other antenna positions may provide improved connectivity.* Follow recommended guidelines and procedure to reposition the antenna.

Antenna Location Guidelines

- Keep the antenna vertical.
- Avoid mounting an antenna near power lines.
- Avoid areas where people could trip on a cable.
- Don't tempt vandals: If possible, keep the antenna out of plain sight.

Changing Antenna Location

1. Turn off AC power, unplug the power cord, and open the back door.
2. Remove 4 screws at front of bezel.



Service Manual

CoinUp®

3. Remove 2 screws from each side of cabinet.
4. Remove 2 screws at the back of the bezel *not pictured.
5. Lift and prop up cabinet bezel.

Be careful to avoid damaging start buttons, card reader, or keypad connections.



6. Unscrew antenna from the cabinet.

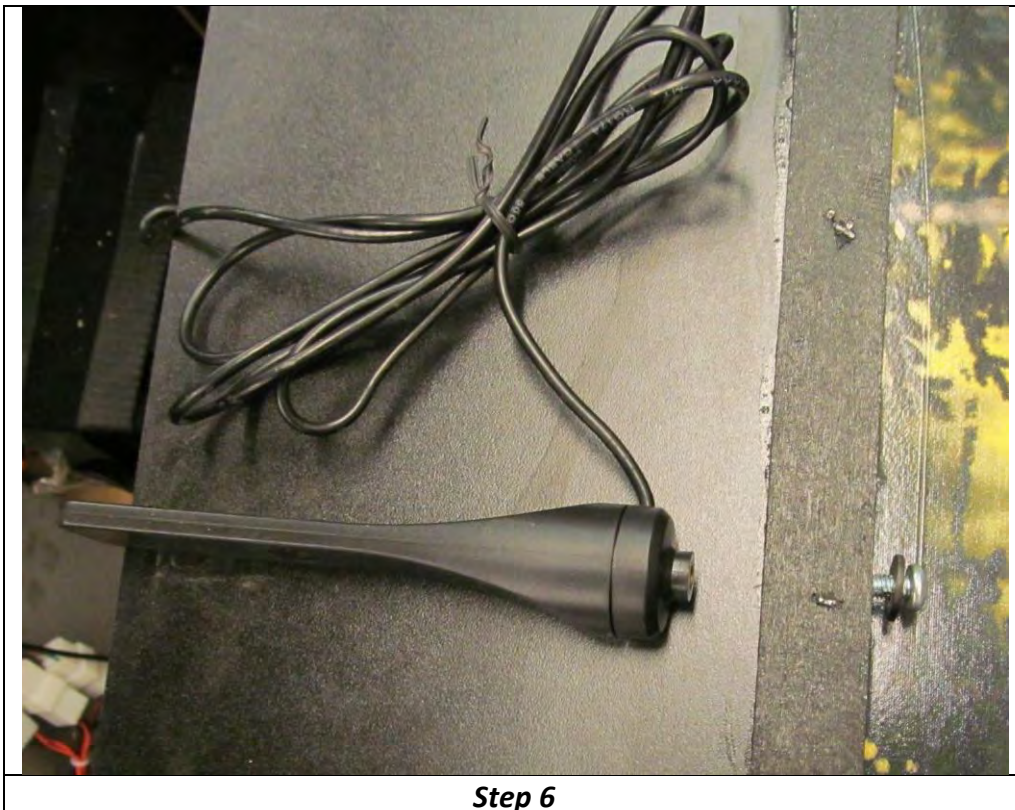



7. Locate cell modem and mounting bracket inside cabinet.

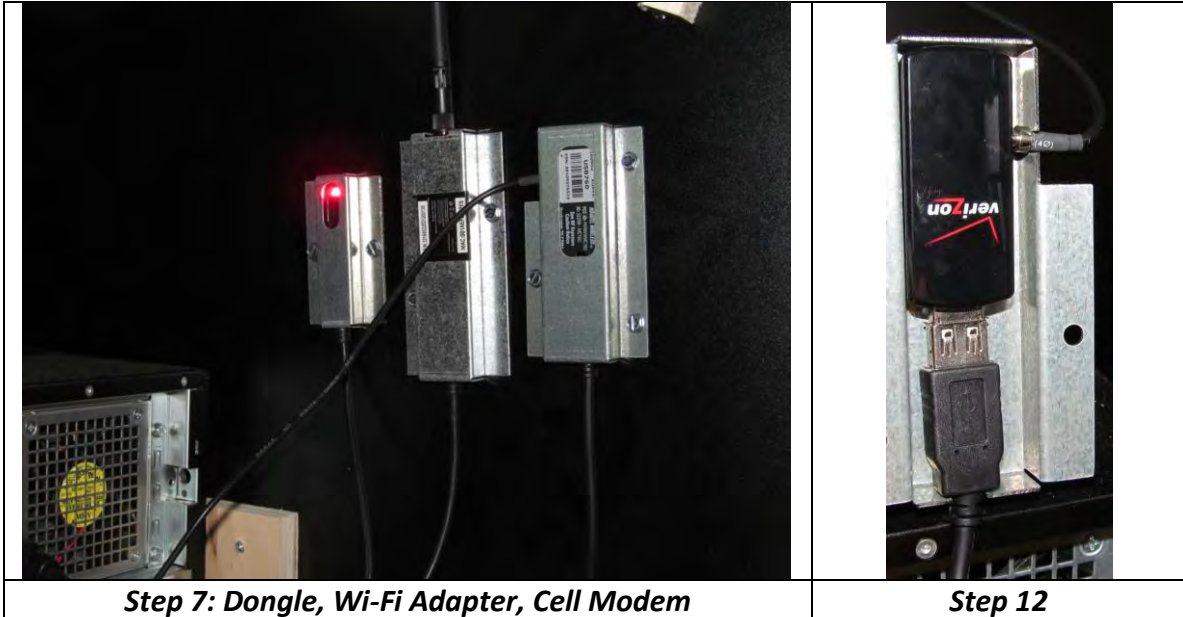

8. Remove cell modem mounting bracket from the cabinet.
9. Disconnect antenna from cell modem.
10. Facing the back of the cabinet, route the antenna cable through the right monitor stanchion.
11. Reconnect antenna to cell modem.
12. Secure cell modem mounting bracket to cabinet.
Be careful to correctly align antenna cable within mounting bracket. Do not pinch cable.
13. Close the back door and turn on AC power.
14. Attach antenna to the included antenna mount.
15. Move antenna to new location.
16. Secure mounting plate to new location using the attached double stick tape.
Use Cellular Information (pg 26) in diagnostic menu to gauge reception to find best location.

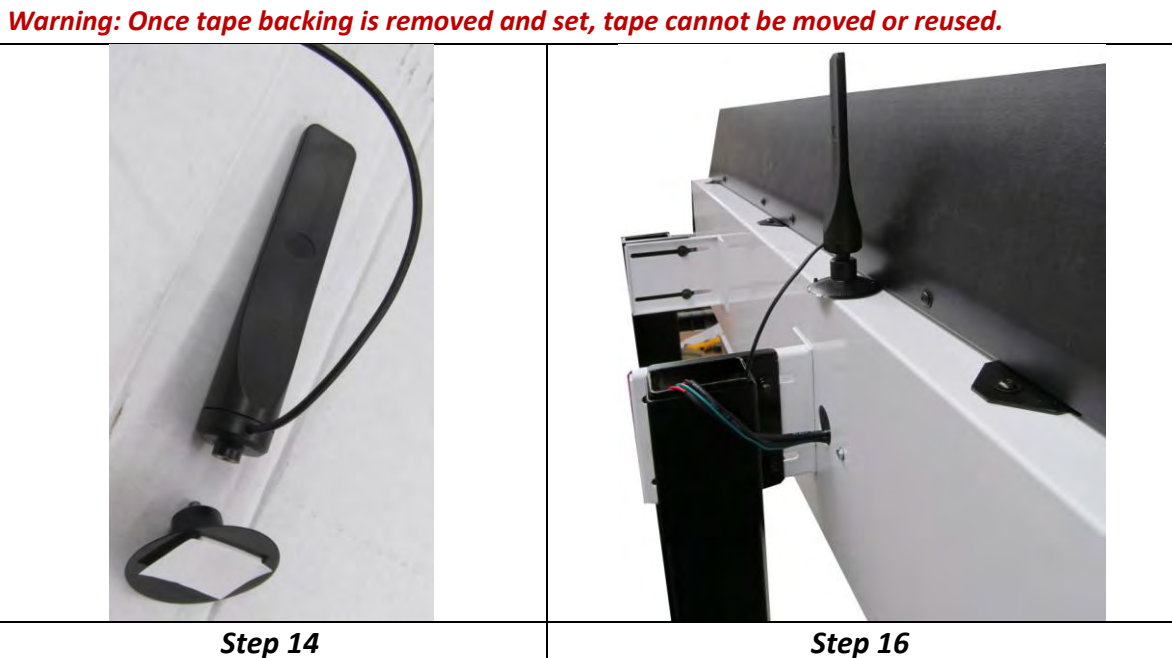

Service Manual

CoinUp®

Wireless Connection - Wi-Fi Adapter

A Wi-Fi adapter comes preinstalled and preconfigured with the cabinet.

Connection Wizard

The connection wizard provides a step-by-step guide to configuring an internet connection. Select a connection type and follow the on screen instructions.

Wired Configuration

- Dynamic will automatically try to assign an IP address to the game machine
- Static allows the game machine to be set with a fixed IP address

Cellular Configuration

- Game will try to dynamically configure cellular connection.

Wireless Configuration

Prepare for Setup

1. Log into wireless access point or router.
2. Write down Wi-Fi network information on a sheet of paper:
 - SSID (network name)
 - Broadcast Channel
 - Encryption Type (WEP 64-bit, WEP 128-bit, WEP 256-bit, WPA-PSK + TKIP encryption, WPA-PSK + AES encryption, WPA2)
 - Encryption Key (Different encryption types require different keys. See below for examples)

Encryption Type	Key Details	Credit Card - PCI Compliant
None/Open	None	NO
WEP	10, 26, or 58 hexadecimal characters	NO
WPA or WPA2	8-63 character ASCII pass phrase	YES

Note: PCI Compliance is required for credit card usage. Game will only allow credit card use if wireless network is encrypted with WPA/WPA2 standards.

Enter Network SSID

1. Start Connection Wizard from Online option in diagnostics menu.
2. Select Wireless. The game will try to scan for available networks.
3. Scroll through the detailed list to locate your network.

*Depending on settings, networks may not broadcast their SSID. These networks are displayed as ****HIDDEN****. To use a hidden network, select it, and enter the SSID manually when prompted.*

4. If network does not appear in list, select rescan to refresh list of available networks. Alternatively, select Enter Manually: enter SSID, encryption type, key and broadcast channel.

Select Encryption Type

This section only appears if Enter Manually was selected.

1. Shoot options to select None, WEP, or WPA/WPA2.
2. Shoot Select Encryption Type to continue.



Enter Encryption Key

If the encryption type is disabled/open, skip this section, because there is no key.

1. Shoot onscreen keyboard to enter security key/passphrase.

Broadcast Channel

This section applies only if the SSID was entered manually.

1. Scroll through the list and shoot to select the appropriate channel.
2. If you are unsure of the correct broadcast channel, select Auto.
3. Shoot Select Channel to continue.

Confirm Wi-Fi Info

This section only appears if Enter Manually was selected.

1. Verify that information on the confirmation screen is correct.
2. If the information is incorrect, select Prev to return to prior sections of Wi-Fi setup.
3. If the information is correct, select OK to store the information.

Select Dynamic or Static

- Dynamic will automatically try to assign an IP address to the game machine
- Static allows the game machine to be set with a fixed IP address

Checking the Connection

Cell or Wi-Fi Users

1. Enter Diagnostic mode by pressing the TEST service button.
2. Select Online – select Cellular Information or Wi-Fi Information.
3. Connection Status should indicate Connected
4. Note the signal strength, which appears as a set of colored bars. Green bars indicate strength. A strong signal is 5/5; a weak signal is 1/5 or 2/5.
5. If strength is below 3/5, reposition and recheck signal strength.

All Users

1. Enter Diagnostic mode by pressing the TEST service button.
2. Select Online then select Connection Details and Test.
3. Execute Test Connection to verify:
 - It can obtain a valid IP address.
 - It can contact the CoinUp® server.
 - It can access the CoinUp® database.
 - It can access the CoinUp® file server.
4. The test results section reports: SUCCESS or FAILURE.
If any ping results in FAILURE, see the Troubleshooting chapter or call your distributor.

Game Registration

After the first reboot with a network connection, you will be prompted to register your location. You can also register by entering the Diagnostic menu, select Online, then select Cabinet Location/Registration.

1. Login by swiping operator card or manually with operator id and pin.
2. Set Cabinet Location screen appears, downloading locations from CoinUp® automatically.
3. Scroll through the list and highlight the appropriate location.
4. Shoot the location to continue.
5. After location is chosen, a confirmation screen is displayed.
6. Shoot Use this Location to continue.
7. If the location is not on the list, shoot Add New Location to continue.
8. When adding a new location, follow step-by-step instructions to provide needed information.

Online Operation

1. Ensure game remains connected to the CoinUp® network.
2. The hard drive stores data about the game location. If the hard drive is removed from the PC, important data will be lost. Do not swap or replace drives without authorization from CoinUp®.
3. Keep game location data accurate. Before moving a game, have the PC communicate with the server, then unregister the game. Re-register the game with updated information at the new location.

Collection Procedure

The CoinUp® server tracks various book-keeping statistics including collections. To see them, log on to the CoinUp® Operator Center page at www.coinup.com and go to the Reports section.

1. During a normal collection, enter Diagnostic mode - select Utilities – select Collection.
2. Detailed breakdowns for Cash Cards, Player Account, Credit Cards, and CoinUp® can be seen in their respective menus.
3. Select Take Collection and Review the entire report.
The system calculates Gross Collection from the last time the report screen was cleared.
This figure and the actual collection should agree.
4. Shoot DO COLLECTION to send collection information.
5. After sending the collections, coin related audits are automatically reset.
This allows coin audits to accurately reflect earnings since the last collection. If you don't send collections, the next collection won't match the figures on the Collections screen and you will not be able to view your collections on www.coinup.com.
If you wish to reset the other game audits, go to Reset Menu and select Reset Game Audits.
6. Split collection with location as usual.
CoinUp® debits your account for its portion.



CoinUp® Fee Schedule

Pricing is subject to change without notice.

For online features, CoinUp® collects a monthly subscription. Additional fees are collected by CoinUp®, but are passed along. Cellular Service fees are passed along to cellular provider, credit card fees are passed along to credit card companies, and tournament prize funding paid for by the players is passed along to any winners. The Operator portion can be adjusted as noted, using coinup.com - under the Game Machines section, or at the game – in Diagnostic menu system, within Operator Adjustments, in Player Cost. Adjustments should be made to each individual game.

Service	Operator Portion	Who Pays	Additional Information
Basic Play			
1-Trek (5 sites 1 bonus)	\$1.00	Player, at game	Operator portion is adjustable
Adventure (3-Treks)	\$3.00	Player, at game	Operator portion is adjustable
Shootout (1-trek or adv)	x2	Player, at game	Operator portion is adjustable
Showdown (2-Treks)	\$2.00	Player, at game	Operator portion is adjustable
Bonus Only (4 bonuses)	\$1.00	Player, at game	Operator portion is adjustable

Classic Tournament

Operator Created Trny	*	Player, at game	Custom created via coinup.com
-----------------------	---	-----------------	---

***Operator is free to customize length of tournament, cost, and prizes.**

Service	Operator Portion	CoinUp® Portion	Who Pays	Additional Information
CoinUp® Sponsored Content				
Add-on Trny Prize Fund	*	+\$1.00	Player, at game	Added to 1-Trek or Adventure cost
Showdown Trny Fund	*	+\$1.00	Player, at game	Added to Showdown cost
National Trny (1-trek)	\$1.00	\$0.00**	Player, at game	Operator portion NOT adjustable
National Trny (2-trek)	\$2.00	\$0.00**	Player, at game	Operator portion NOT adjustable
National Trny (3-trek)	\$3.00	\$0.00**	Player, at game	Operator portion NOT adjustable

***Operator portion remains per basic play above. CoinUp® portion is collected to fund prize table; this funding fee is passed directly on to winning players.**

****CoinUp® does not collect a funding fee for national tournaments. Prize table is completely funded by CoinUp®.**

Service	Cost	Who Pays	Additional Information
CoinUp® Service - Per unit			
Online Subscription*	\$24.99	Operator	Taxes may apply
Cellular Service **	\$18.00	Operator	Pass through service fees
Credit Card Fees***	4% + fixed fees	Operator	Pass through service fees
Tournament Funding	****	Player, at game	Pass through prize funding

***This is the monthly service fee to CoinUp® which is accrued at a rate of \$0.82 per day.**

**** Cellular Service is collected by CoinUp®, passed along to cellular provider, accrued at a rate of \$0.59 per day.**

*****This is a flat percent of monthly usage plus a fixed fee per transaction, collected by CoinUp®, passed along to the credit card companies.**

******Tournament Funding will vary based on monthly gameplay and usage.**

Accounting Guidelines

After the close of each billing cycle, the monthly CoinUp® billing statement, itemizing the costs of online services, is viewable through the operator account at www.coinup.com.

The statement shows the approximate date of the automatic debit, allowing time to deposit appropriate funds. The automatic debit charges the bank account submitted on your debit account form.

CoinUp® honors company checks but must receive them three or more business days before the debit date. Late or delinquent deposits may exclude a game from access to online features and incur late fees.

Troubleshooting

Warning: Review safety chapter before making any adjustments to game.

General Troubleshooting

Problem	Possible Cause	Solution
Game will not power up	Game not plugged in.	Plug game into outlet.
	Game not turned on.	Turn on main power switch.
	Game fuse is blown.	Check and replace fuse.
	No power to receptacle.	Test outlet and plug game into powered outlet.
	PC not turned on.	Turn PC power switch on. Ensure IEC cable tightly plugged in. Trace cable back to source to ensure continuity.
	PC BIOS set incorrectly.	See BIOS Settings chapter.
Screen not powering on with game	TV Auto On not set	Consult TV manual for details.
NO VIDEO message	Video cables not plugged in properly	Reattach and/or tighten video cable to monitor. Reattach and/or tighten video cable to PC.
	Faulty video cable	Replace video cable
	PC not turned on.	Turn PC power switch on.
No sound	Bad Connection	Check connection to speakers.
Game does not load	Hard drive failure	Recover hard drive. See procedure on pg 18.
Hard drive test reports "bad" or "missing" files.		
Game fails to finish loading.		
After resetting, game still reports an error.		
Game suggests inserting a boot DVD.		
Erratic game mode or attract mode.		
<p style="text-align: center;">WARNING! Data Files Corrupted. (Game Operation May Become Unstable.) Use "Test" Switch to Enter Test Mode and Run "File Test." Press Start To Continue.</p>		
Game resets	Bad file.	Run File Test. Restore hard drive.



Message	Possible Cause	Solution
Guns won't register, or function poorly	Bad calibration	Calibrate guns.
	Dirty/damaged lens	Clean gun lens.
	Gun disconnected	Check USB connections.
Coin meter does not click during Test	No pulse to meter	Check all wiring from meter to I/O board
	Faulty meter	Replace coin meter
Exits Test Mode every 3 seconds	Test button stuck in ON position	Slide or toggle button off after Test Menu appears
<i>Dongle Not Present</i>	Dongle missing or disconnected	Find dongle usb connection and reseal in USB port
	Faulty USB port	Connect dongle to another USB port
<i>Connect I/O Board or I/O Board Missing</i>	USB cable disconnected	Check USB connection from PC to I/O board Try connecting to a different USB port
	Blown fuse	Verify 5V and 12V fuses are not blown
	No power to RIO board	Check for proper voltage (+5V, +12V) at RIO P2 connector
	Bad RIO Board	Replace RIO board with known functional board

Connection to CoinUp® Troubleshooting

General Connection Troubleshooting

Problem	Possible Cause	Solution
Connection Details and Test has IP address but Test Connection reports Database Ping failure or File Server Ping failure.	Firewall is blocking communication with server.	Read firewall documentation. Ensure configuration allows ICMP Echo. If router has built-in firewall, check router configuration. Enable communication on ports 80, 443, 7786, and 7787.
	Database or File Server is down	Wait 30 minutes and revisit Test Connection screen. If still reporting failure, call CoinUp® service.

Ethernet Connection Troubleshooting

Problem	Possible Cause	Solution
Game cannot connect to CoinUp® server. No IP address appears under Connection Details and Test	No broadband internet service	Contact a local ISP to setup either cable modem or DSL service.
	Wrong router configuration	Configure router for DHCP (Dynamic Host Configuration Protocol).
	Disconnected Ethernet cable	Check that Ethernet cables are tightly connected at both ends. An audible click confirms tightness. Reboot game. In Diagnostic mode, select Online, then Test Connection. Confirm that IP address appears. The phrase eth0 must follow IP address.
	Faulty Ethernet cable	Test cable by connecting it from another PC into router or wall jack. Replace cable if faulty.
	Faulty Ethernet wall jack.	Plug Ethernet cable into a different jack.
	Broadband service is down.	Contact ISP.
	Faulty router	Plug Ethernet cable into different jacks in router. Plug Ethernet cable directly into DSL or cable modem instead of router. Replace router if faulty.
	Faulty network card	Call CoinUp® service



Cellular Connection Troubleshooting

Problem	Possible Cause	Solution
<p>Game cannot connect to CoinUp® server</p> <p>No IP address appears in Connection Details and Test</p> <p>Connection Details and Test reports failures</p>	Poor connection between cell modem and PC.	<p>Check that USB connections at cell modem and PC are tight. Turn off cabinet AC power. Wait 30 seconds and reboot game.</p> <p>If still not connected, enter Diag, select Online, and then select Cellular Information.</p> <p>If message is <i>No Modem Found</i> or <i>Collecting Data</i>, call CoinUp® service.</p>
	Faulty cell modem	<p>Ensure PWR LED on cell modem glows green, which means PC is providing modem with power.</p> <p>If no power, swap with working modem. Check modem for obvious damage (dents, burns, smoke damage, broken connectors)</p> <p>If modem seems fine, call CoinUp® service.</p>
<p>Cell modem connection is good and IP address appears at Test Connection screen. Under Cell Modem Details, signal is weak or nonexistent.</p>	Poor antenna location	Change placement of antenna and/or cabinet.
	Faulty connection	Check connections between cell modem and antenna. Replace antenna if it appears damaged.

Wi-Fi Connection Troubleshooting

Problem	Possible Cause	Solution
<p>Wi-Fi Details status is <i>Not Connected</i> or Adapter is <i>Not Found</i>.</p>	A supported USB Wi-Fi adapter is not connected.	Connect a supported Wi-Fi adapter. Turn cabinet AC power off for a minute and reboot.
	Faulty USB port	Connect device to another USB port
<p>Wi-Fi Details status is <i>Not Connected</i>, but a supported adapter is connected.</p>	Wi-Fi network information is incorrect	Run connection wizard and select Wireless. Enter required information.
	Wireless access point or router is off or disconnected.	Ensure access point has power. Ensure it is connected to router. Restart access point. Ensure router has power and is connected to cable/DSL modem.

Parts

BBHD Vacform Assembly

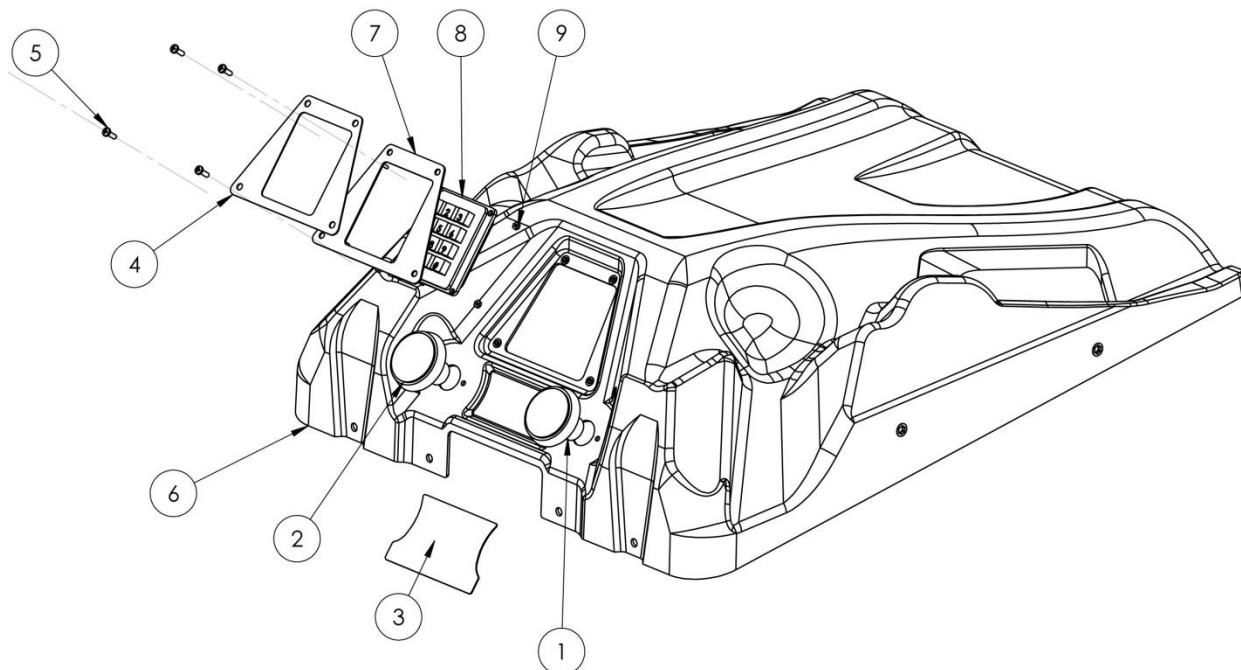

Item	Part No.	Description	QTY
1	702-00008-01	ORANGE ROUND ILLUM PB	1
2	702-00007-01	GREEN ROUND ILLUM PB	1
3	606-00680-01	DECAL- C'PANNEL-BBHD	1
4	606-00683-01	DECAL-KEYPAD-BBHD	1
5	CR-PHMS 0.164-32x0.5x0.5-N	8-32 X .50 BUT-HD-BLK-BOLT	4
6	603-00567-01	VACFORM-C'PANEL-BBHD	1
7	600-00888-01	PLATE-KEYPAD	1
8	813-00006-01	KEYPAD-ATM STYLE – KEY TEK	1
9	MSHXNUT 0.112-40-S-N	4-40 – NYLOCK NUT	4

Monitor Mounting Screws

Item	Part No.	Description	QTY
1	31-MSM06-01-002	6MM X 30 MM LG H.H.M.S. STL-ZINC	4
2	31-MSM06-01-004	6MM X 16 MM LG H.H.M.S. STL-ZINC	4
3	31-MSM08-03-003	8MM-1.25 X 16MM LG H.H.M.S STL-ZINC	4
4	31-MSM08-03-004	8MM-1.25 X 30MM LG H.H.M.S STL-ZINC	4
5	3-102	WASHER 5/16ID X .750OD X 1/16THK STL-ZINC	4
6	4-748	PLASTIC SPACER - .75 OD X .325 ID X .50 THK	4
7	3-400-25	1/4 EXTERNAL TOOTH LOCKWASHER	4
8	3-400-31	5/16 EXTERNAL TOOTH LOCKWASHER	4

Service Manual

Parts

Panorama Cabinet Assembly Part Numbers

Item	Part No.	Description	QTY
1	601-00577-01	BBHD-42-WOOD-CAB-ASSY	1
2	601-00579-01	ASSY-REAR DOOR - 42 BBHD	1
3	BBHD-42LCD-STAND-ASSY	BBHD-42LCD-STAND-ASSY	1
4	BBHD-VACFORM-ASSY	BBHD-VACFORM-ASSY	1
5	CARD-SWIPE-ASSY	CARD-SWIPE-ASSY	1
6	800-00005-01	MID-WIDTH COINDOOR - BBHD	1
7	BETSON 47-4450-XX	GUN MOUNTING PLATE	2
8	600-00772-01	GRILL-SPEAKER-BBHD	1
9	SX-RIO ASSY	SX-RIO PCB ASSY - BBHD	1
10	807-00003-00	SPEAKER-6.5 INCH WOOFER-8OHM	1
11	2-1-02-00-00-017	APS_POWER_SUPPLY_WITH_BRACKET 90-AP-188	1
12	820-00001-00	FAN-120MM-120VAC-15/19W	1
13	800-00001-00	GUARD-FAN-WIRE-120MM	1
14	2-1-10-00-00-000	5.25 Full Range Speaker	2
15	Optiplex 390 Assy	Optiplex 390 Assy-BBHD	1
16	810-00053-01	TEST SERVICE BUTTON ASSY	1
17	820-00018-00	BBHD-COMPLETE GUN-ORANGE	1
18	820-00019-00	BBHD-COMPLETE GUN-GREEN	1
19	600-00901-01	BRACKET-PC STRAP MOUNT	2
20	Foam-pc-.5x8x14.5	FOAM-PC-.5X8X14.5 - POLYETHYLENE PLANK	1
21	87425k76 (56" LG)	NYLON STRIP 0.075" THICK, 1" WIDTH, BLACK (56" LG)	2
22	29705K76 (FEMALE)	PLASTIC BUCKLE FOR 1"WEB, NO SEW RELEASE - FEMALE	2
23	29705K76 (MALE)	PLASTIC BUCKLE FOR 1"WEB, NO SEW RELEASE - MALE	2
24	606-00676-01	DECAL-LEFT SIDE PANEL	1
25	606-00677-01	DECAL-RIGHT SIDE PANEL	1
26	606-00678-01	DECAL-TOP CAB	1
27	606-00685-01	DECAL-VINYL-FRONT PANEL	1
28	606-00696-01	DECAL-OVAL GUN-BBHD	4
29	IN-HWMS 0.19-32X0.75X0.75-N	10-32 X .75LG HWH MACHINE SCREW	5
30	Regular FW 0.138	#6 FLAT WASHER - BLACK	4
31	CR-PHMS 0.138-32X1.25X1-N	6-32 X 1.25LG TP-BH MACHINE SCREW - BLACK	4
32	FHTS 0.112-24-AB-0.8125-N	#8 X .75LG WOOD SCREW	8
33	PANHTS 0.112-24-TYPE 1-BP-0.8125-N	#8 TP-BH WOOD SCREW - BLACK	3
34	BB142090UHD	1/4-20 X 3.547LG DEC.HEAD JOINT BOLT (STAFAST)	4
35	MSHXNUT 0.250-20-S-N	1/4-20 NYLOCK NUT	4
36	CR-PHMS 0.164-32X1.625X1-N	8-32 X 2.25LG PHILIPS HEAD MACHINE SCREW	4
37	MSHXNUT 0.164-32-S-N	8-32 NYLOCK NUT	4
38	RHSNBOLT 0.19-24X1.5X.75-N	10-24 X 1.25LG CARRAIGE BOLT - BLACK	6
39	Regular FW 0.19	#10 FLAT WASHER	10
40	MSHXNUT 0.190-24-S-N	10-24 NYLOCK NUT	6
41	IN-HWMS 0.138-32X0.5X0.5-N	#8 X .50LG SHEET METAL SCREW	2
42	CR-PHMS 0.25-20X0.75X0.75-N	1/4-20 X 1.25LG TP-BH-BOLT-BLACK	6
43	CR-PHMS 0.25-20X0.75X0.75-N	1/4-20 X .75LG TP-BH-BOLT-BLACK	4
44	Regular LW 0.25	1/4" SPLIT LOCK WASHER	3
45	HFBOLT 0.25-20X1X0.75-N	1/4-20 X .75LG HH BOLT	3
46	FHTS 0.112-24-BP-0.8125-N	#8 X .75LG WOOD SCREW	4
47	CR-PHMS 0.19-24X0.625X0.625-N	#10 X .63LG WOOD SCREW	8



32" Cabinet Assembly

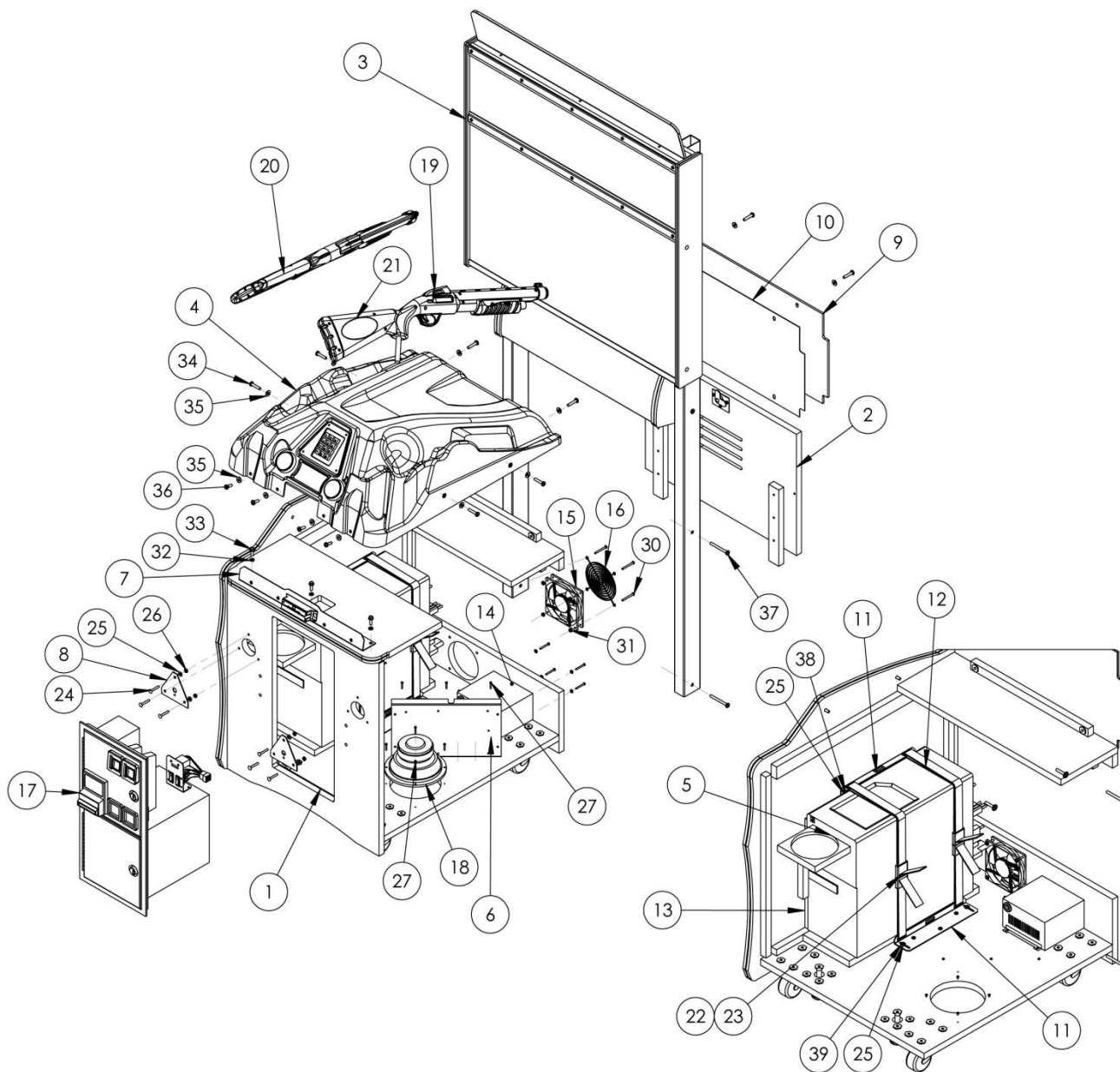

Service Manual

Parts

32" Cabinet Assembly Part Numbers

Item	Part No.	Description	QTY
1	601-00565-01	ASSY-WOOD-32" CAB-BBHD	1
2	601-00566-00	ASSY-REAR DOOR - 32"CAB-BBHD	1
3	601-00568-01	ASSY-WOOD-32"LCDBOX-BBHD	1
4	BBHD-VACFORM-ASSY	BBHD-VACFORM-ASSY	1
5	Optiplex 390 Assy	Optiplex 390 Assy-BBHD	1
6	SX-RIO ASSY	SX-RIO PCB ASSY - BBHD	1
7	CARD-SWIPE-ASSY	CARD-SWIPE-ASSY	1
8	BETSON 47-4450-XX	GUN MOUNTING PLATE	2
9	600-00896-01	SINTRA-GRAPHICS PANEL	1
10	606-00719-01	DECAL- GRAPHICS PANEL (LOWER BLOCKER)	1
11	600-00901-01	BRACKET-PC STRAP MOUNT	2
12	87425K76 (56" LG)	NYLON STRIP 0.075" THICK, 1" WIDTH, BLACK (56" LG)	2
13	FOAM-PC-.5X8X14.5	FOAM-PC-.5X8X14.5 - POLYETHYLENE PLANK	1
14	2-1-02-00-00-017	APS_POWER_SUPPLY_WITH_BRACKET 90-AP-188	1
15	820-00001-00	FAN-120MM-120VAC-15/19W	1
16	800-00001-00	GUARD-FAN-WIRE-120MM	1
17	800-00005-01	MID-WIDTH COINDOOR - BBHD	1
18	807-00003-00	SPEAKER-6.5 INCH WOOFER-8OHM	1
19	820-00018-00	BBHD-COMPLETE GUN-ORANGE	1
20	820-00019-00	BBHD-COMPLETE GUN-GREEN	1
21	606-00696-01	DECAL-OVAL GUN-BBHD	4
22	29705K76 (FEMALE)	PLASTIC BUCKLE FOR 1"WEB, NO SEW RELEASE - FEMALE	2
23	29705K76 (MALE)	PLASTIC BUCKLE FOR 1"WEB, NO SEW RELEASE - MALE	2
24	RHFNBOLT 0.19-24X1.25X.75-N	10-32 X 1.25LG CARRAIGE BOLT - BLK	6
25	Preferred Narrow FW 0.19	#10 FLAT WASHER - ZINC	10
26	MSHXNUT 0.190-32-S-N	10-32 NYLOCK NUT	6
27	FHTS 0.112-24-AB-0.8125-N	#8 X .75LG WOOD SCREW	7
28	CR-PHMS 0.138-32X1.25X1-N	6-32 X 1.25LG TP-BH-MS-BLK	4
29	Preferred Narrow FW 0.138	#6 FLAT WASHER - BLK	4
30	CR-PHMS 0.164-32x1.625x1-N	8-32 X 2.25LG TP-BH-MS-BLK	4
31	MSHXNUT 0.164-32-S-N	8-32 NYLOCK NUT	4
32	Regular LW 0.25	1/4" SPLIT LOCK WASHER	3
33	IN-HWMS 0.25-20X0.75X0.75-N	1/4-20 X .75LG HH-BOLT	3
34	CR-PHMS 0.25-20X1.25X1-N	1/4-20 X 1.25LG TP-BH-MS-BLK	8
35	Preferred Narrow FW 0.25	1/4" FLAT WASHER - BLK	12
36	CR-PHMS 0.25-20X0.75X0.75-N	1/4-20 X .75LG TP-BH-MS-BLK	4
37	BB142070UHD	1/4-20 X 2.756LG DEC HEAD JOINT BOLT (STAFAST)	4
38	CR-PHMS 0.19-24X0.625X0.625-N	#10 X .63"LG WOOD SCREW	5
39	CR-PHMS 0.19-32X0.75X0.75-N	10-32 X .75LG HWH MACHINE SCREW	5



32" Monitor Assembly

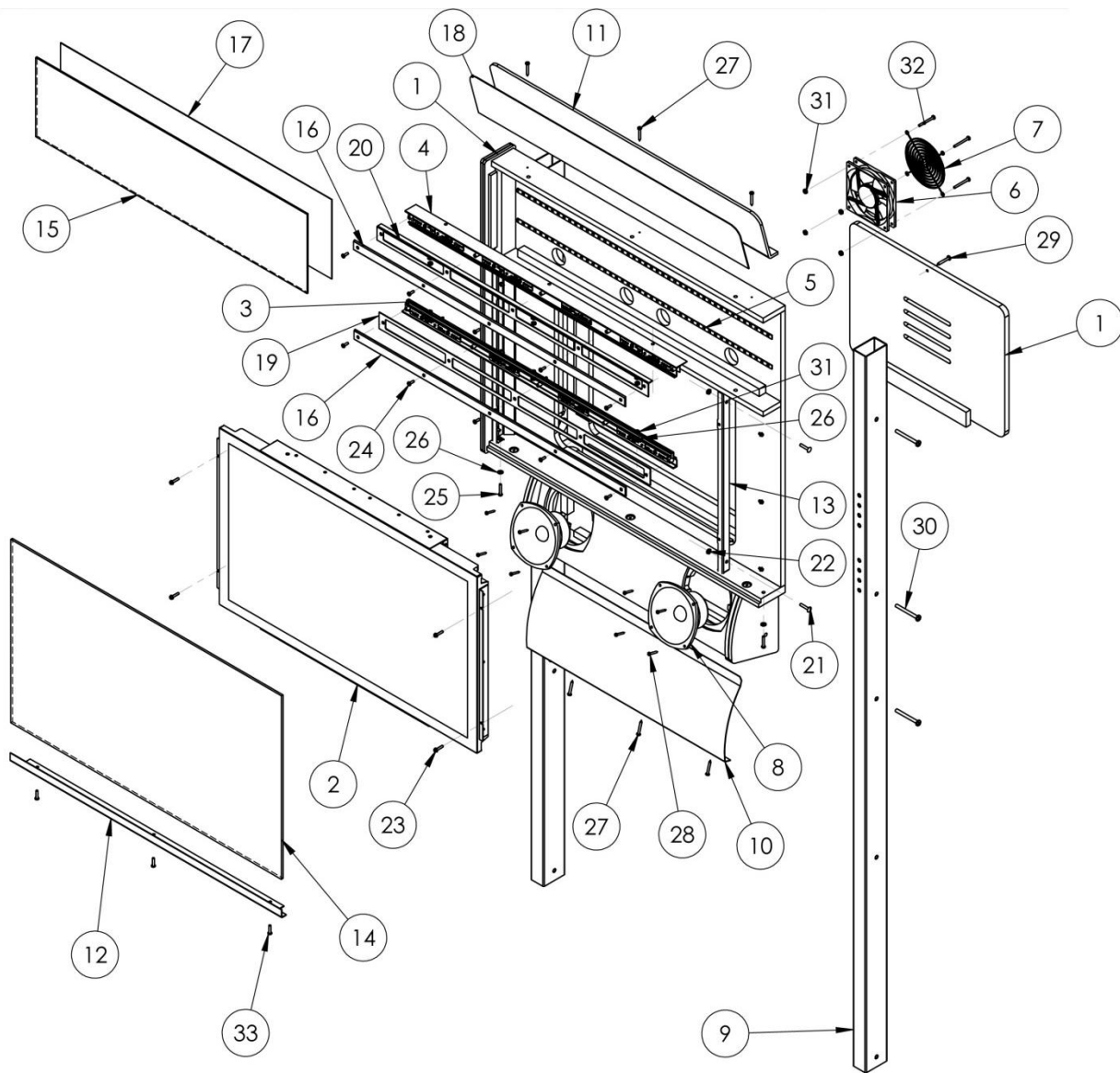

Service Manual

Parts

32" Monitor Assembly Part Numbers

Item	Part No.	Description	QTY
1	601-00568-01	ASSY-WOOD-32"LCDBOX	1
2	ASSY-32"OEM-LCD-WOOD	ASSY-32"OEM-LCD-WOOD	1
3	ASSY-BTM-LED-ARRAY-32"BBHD	ASSY-BTM-LED-ARRAY-32"BBHD	1
4	ASSY-TOP-LED-ARRAY-32"BBHD	ASSY-TOP-LED-ARRAY-32"BBHD	1
5	White LED Strip-30	30" LG WHITE LED STRIP	2
6	820-00001-00	FAN-120MM-120VAC-15/19W	1
7	800-00001-00	GUARD-FAN-WIRE-120MM	1
8	2-1-10-00-00-000	5.25 Full Range Speaker	2
9	600-00745-01	TUBE-42"LCD MOUNT-BBHD	2
10	600-00772-01	GRILL-SPEAKER-BBHD	1
11	600-00820-01	BLOCKER-SINTRA-TOP MARQ	1
12	600-00747-01	RETAINER-GLASS-32"LCD	1
13	600-00748-01	BRACKET-32"LCD-WOOD MOUNT	2
14	600-00755-01	GLASS-32"LCD-WOOD-MOUNT	1
15	600-00775-01	PLEX-MARQUEE-32" BBHD	1
16	600-00818-01	PLEX-SMOKED-32"MARQUEE-BBHD	2
17	606-00702-01	TRANSLITE-32" MARQUEE-BBHD	1
18	606-00701-01	DECAL-32" BLOCKER-BBHD	1
19	600-00898-01	PLATE- LOWER IR RETENTION	1
20	600-00907-01	PLATE- TOP IR RETENSION	1
21	RHFNBOLT 0.19-24x1x.75-N	10-32 X 1.00", CARRAIGE BOLT-BLK	4
22	MSHXNUT 0.190-32-S-N	10-32 KEP NUT	4
23	IN-HWMS 0.164-32x0.75x0.75-N	8-32 X 1.00LG HEX WASHER HEAD-MS-ZINC	4
24	CR-PHMS 0.164-32x0.5x0.5-N	8-32 X .50LG-TP-BH-BLK-MS	10
25	CR-PHMS 0.164-32x1x1-N	8-32 X 1.00LG-TP-BH-BLK-MS	2
26	Preferred Narrow FW 0.164	#8 BLK WASHER	8
27	PANHTS 0.164-19-type I-AB-1.25-N	#8 X .75LG TP-WOOD SCREW - BLK	6
28	PANHTS 0.138-20-type I-AB-1-N	#8 X .50LG PHIL-WOOD SCREW-ZINC	8
29	PANHTS 0.19-16-type I-AB-1.375-N	#8 X 1.25LG PHIL - MS - BLK	1
30	BB142070UHD	1/4-20 X 2.756LG DEC.HEAD JOINT BOLT (STAFAST	6
31	MSHXNUT 0.164-32-S-N	8-32 NYLOCK NUT	10
32	CR-PHMS 0.164-32x1.625x1-N	8-32 X 2.25LG PHIL-MS-BLK	4
33	CR-PHMS 0.164-32x0.75x0.75-N	8-32 X .75LG - TP-BH-BLK-MS	3



BBHD Gun Assembly
Green Gun Parts and Assembly

ITEM NO.	PART NUMBER	DESCRIPTION	QTY.
1	600-00846-01	RIGHT GUN HALF	1
2	600-00847-01	LEFT GUN HALF	1
3	600-00849-01	GUN BUTT - GREEN	1
4	600-00851-01	GUN TIP - GREEN	1
5	600-00852-01	IR FILTER LENS	1
6	600-00853-01	PUMP STOP	2
7	600-00854-01	RIGHT PUMP HALF	1
8	600-00855-01	LEFT PUMP HALF	1
9	810-00131-01	HOSE ASSEMBLY	1
10	500-00095-01	PCB	1
11	825-00001-01	CAMERA MODULE	1
12	600-00856-01	TRIGGER	1
13	600-00857-01	TRIGGER SPRING	1
14	600-00858-01	PUMP SPRING	1
15	600-00859-01	SPRING STOP WASHER	1
16	606-00696-01	OVAL DECAL	2
17	600-00860-01	TRIGGER GUARD	1
18	600-00861-01	PUMP ROD	1
19	600-00862-01	SWITCH SHIM	3
20		6-32 NUT	5
21		6-32 NYLOCK NUT	6
22		6-32 X 5/16" TAMPERPROOF SCREW	2
23		6-32 X 5/8" TAMPERPROOF SCREW	6
24		10-32 X 1 1/4 TAMPERPROOF SCREW	2
25		2-28 X 1/2" PHILLIPS THREADFORMING SCREW	6
26		10-32 NYLOCK NUT	2
27		4-40 X 1/2" SCREW	1
28		4-40 NUT	1
29		6-32 X 1/4" TAMPERPROOF SCREW	3
30		6-32 X 1" TAMPERPROOF SCREW	2

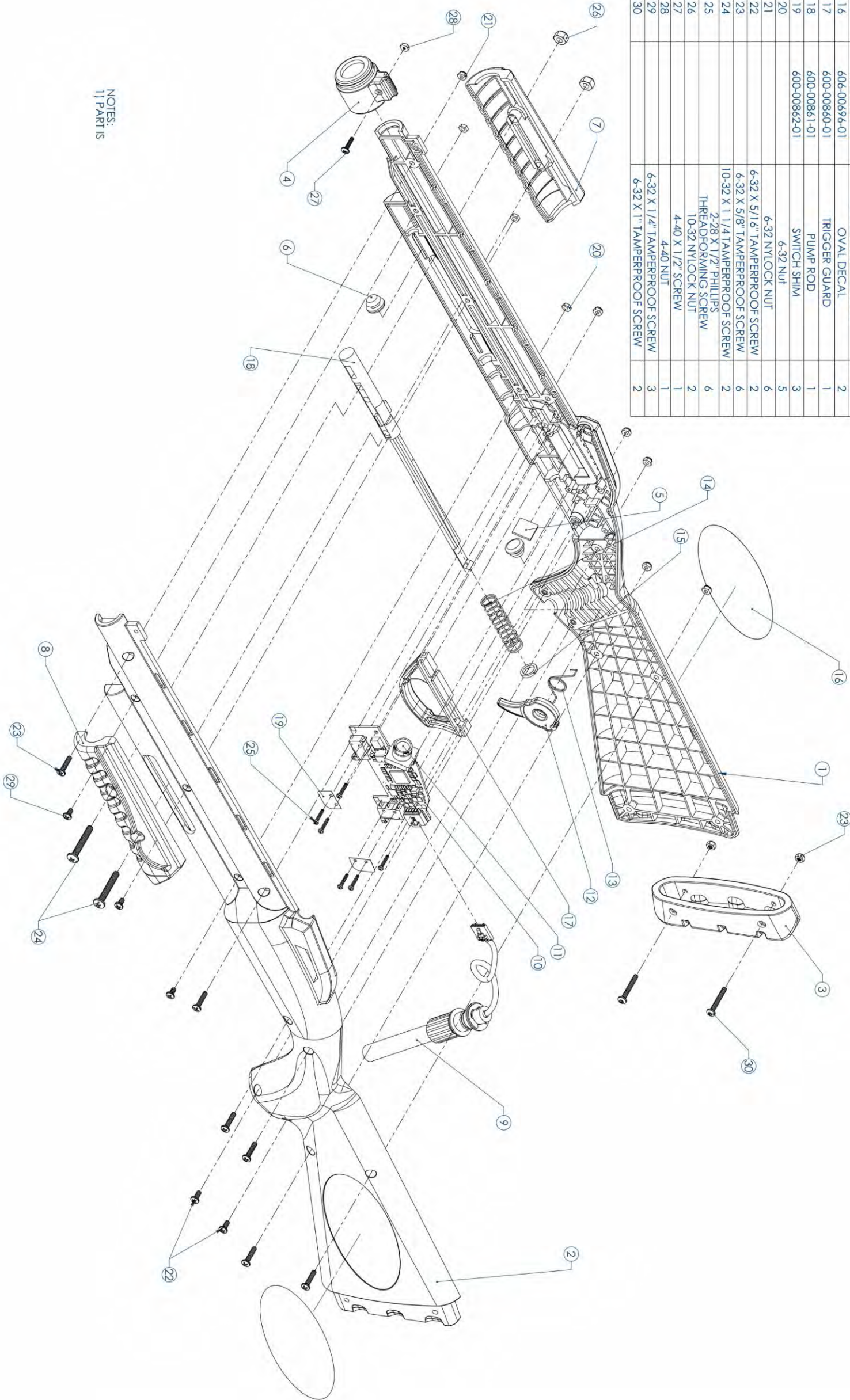

NOTES:
 1) PART IS

ITEM NO.	PART NUMBER	DESCRIPTION	QTY.
1	600-00846-01	RIGHT GUN HALF	1
2	600-00847-01	LEFT GUN HALF	1
3	600-00848-01	GUN BUTT - ORANGE	1
4	600-00850-01	GUN TIP - ORANGE	1
5	600-00852-01	IR FILTER LENS	1
6	600-00853-01	PUMP STOP	2
7	600-00854-01	RIGHT PUMP HALF	1
8	600-00855-01	LEFT PUMP HALF	1
9	810-00131-01	HOSE ASSEMBLY	1
10	500-00095-01	PCB	1
11	825-00001-01	CAMERA MODULE	1
12	600-00856-01	TRIGGER	1
13	600-00857-01	TRIGGER SPRING	1
14	600-00858-01	PUMP SPRING	1
15	600-00859-01	SPRING STOP WASHER	1
16	606-00696-01	OVAL DECAL	2
17	600-00860-01	TRIGGER GUARD	1
18	600-00861-01	PUMP ROD	1
19	600-00862-01	SWITCH SHIM	3
20		6-32 NUT	5
21		6-32 NYLOCK NUT	6
22		6-32 X 5/16" TAMPERPROOF SCREW	2
23		6-32 X 5/8" TAMPERPROOF SCREW	6
24		10-32 X 1 1/4 TAMPERPROOF SCREW	2
25		2-28 X 1/2" PHILLIPS THREADFORMING SCREW	6
26		10-32 NYLOCK NUT	2
27		4-40 X 1/2" SCREW	1
28		4-40 NUT	1
29		6-32 X 1/4" TAMPERPROOF SCREW	3
30		6-32 X 1" TAMPERPROOF SCREW	2

