

Bally

January 27, 1998
16-10648

The **CHAMPION** **PUB**



OPERATIONS HANDBOOK

Williams Electronics Games, Inc., 3401 N. California Avenue, Chicago, IL 60618

TABLE OF CONTENTS

MAIN MENU	1
LAMP LOCATIONS	2
SWITCH LOCATIONS	4
SOLENOID/FLASHLAMP LOCATIONS	6
UPPER PLAYFIELD PARTS LOCATIONS	8
LOWER PLAYFIELD PARTS LOCATIONS	10
LED LIST	12
FUSE LIST	13
LAMP MATRIX	14
SWITCH MATRIX	15
SOLENOID/FLASHLAMP TABLE	16

MENU SYSTEM OPERATION

The Main Menu allows you to choose from several options, which in turn lead to other menus to choose from. To access the Main Menu open the coin door, press the Begin Test button, then the Enter button. Press the Up and Down buttons to scroll through the Main Menu. To access a menu, (Bookkeeping, Printouts, etc.), from the Main Menu, press the Enter button. To return to the Main Menu (from Bookkeeping, Printouts, etc.) press the Escape button. Press the Start button for HELP.

MAIN MENU

B. BOOKKEEPING MENU

B.1 Main Audits	Press Escape
B.2 Earning Audits	To move out of a menu selection.
B.3 Standard Audits	
B.4 Feature Audits	Press Enter
B.5 Histograms	To get into a menu selection.
B.6 Time-Stamps	

P. PRINTOUTS MENU

P.1 Earnings Data	Press Up
P.2 Main Audits	Increases sequence; Example A.1, A.2, A.3, A.4.
P.3 Standard Audits	Press Down
P.4 Feature Audits	Decreases sequence; Example A.4, A.3, A.2, A.1.
P.5 Score Histograms	
P.6 Time Histograms	Use Up or Down to cycle through the selections in a menu.
P.7 Time-Stamps	
P.8 All Data	

T. TEST MENU

T.1 Switch Edges Test	Use Escape and Enter to move into and out of the selected menu.
T.2 Switch Levels Test	
T.3 Single Switches Test	
T.4 Solenoid Test	
T.5 Flasher Test	
T.6 General Illumination Test	
T.7 Sound and Music Test	
T.8 Single Lamp Test	
T.9 All Lamps Test	
T.10 Lamp and Flasher Test	
T.11 Display Test	
T.12 Flipper Coil Test	
T.13 Ordered Lamps Test	
T.14 Lamp Row-Col.	
T.15 DIP Switch Test	
T.16 Jump Rope Test	
T.17 Boxer Test	
T.18 LED Bar Test	
T.19 Empty Balls Test	

U. UTILITIES MENU

U.1 Clear Audits
U.2 Clear Coins
U.3 Reset H.S.T.D.
U.4 Set Time and Date
U.5 Custom Message
U.6 Set Game I.D.
U.7 Factory Adjustments
U.8 Factory Resets
U.9 Presets
U.10 Clear Credits
U.11 Auto Burn-in

A. ADJUSTMENT MENU

A.1 Standard Adjustments
A.2 Feature Adjustments
A.3 Pricing Adjustments
A.4 H.S.T.D. Adjustments
A.5 Printer Adjustments

Lamp Locations

Item Number	Lamp Assembly Part Number	Bulb Type	Bulb Part Number	Socket Part Number	Description
11	A-21808	#555	24-8768	24-8767	HEAVY BAG COMPLETE
12	A-21808	#555	24-8768	24-8767	JUMP ROPE COMPLETE
13	A-21808	#555	24-8768	24-8767	SPEED BAG COMPLETE
14	A-22196	#555	24-8768	24-8767	RIGHT JAB COMBO
15	A-22196	#555	24-8768	24-8767	LOCK
16	A-22196	#555	24-8768	24-8767	RIGHT START FIGHT
17	A-22196	#555	24-8768	24-8767	RIGHT JACKPOT
18	A-22196	#555	24-8768	24-8767	RIGHT JAB
21	A-22194	#555	24-8768	24-8767	BOUT 1
22	A-22194	#555	24-8768	24-8767	BOUT 2
23	A-22194	#555	24-8768	24-8767	BOUT 3
24	A-22194	#555	24-8768	24-8767	BOUT 4
25	A-22202	#555	24-8768	24-8767	JUMP ROPE
26	A-22202	#555	24-8768	24-8767	LEFT JAB COMBO
27	A-22202	#555	24-8768	24-8767	CENTER START FIGHT
28	A-22202	#555	24-8768	24-8767	LEFT JAB
31	A-22195	#555	24-8768	24-8767	LOWER BLUE ARROW
32	A-22195	#555	24-8768	24-8767	LEFT HOOK TO WIN
33	A-22195	#555	24-8768	24-8767	WHITE ARROW
34	A-22195	#555	24-8768	24-8767	THROWN TOWEL
35	A-22195	#555	24-8768	24-8767	CENTER BLUR ARROW
36	A-22195	#555	24-8768	24-8767	LOWER YELLOW ARROW
37	A-22195	#555	24-8768	24-8767	TOP YELLOW ARROW
38					NOT USED
41	A-22201	#555	24-8768	24-8767	LEFT HOOK
42	A-22201	#555	24-8768	24-8767	BODY BLOW
43	A-22201	#555	24-8768	24-8767	RIGHT HOOK
44	A-22201	#555	24-8768	24-8767	CENTER JACKPOT
45	A-22201	#555	24-8768	24-8767	LEFT KO BOXER
46	A-22201	#555	24-8768	24-8767	HURRY-UP
47	A-22201	#555	24-8768	24-8767	HEAVY BAG
48	A-22201	#555	24-8768	24-8767	RIGHT KO BOXER
51	A-22193	#555	24-8768	24-8767	JACKPOT COMPLETE
52	A-22193	#555	24-8768	24-8767	PUB CHAMPION
53	A-22193	#555	24-8768	24-8767	WON BY KO
54	A-22193	#555	24-8768	24-8767	MULTIBALLS COMPLETE
55	A-22193	#555	24-8768	24-8767	TRAINING COMPLETE
56	A-21808	#555	24-8768	24-8767	SPEED BAG
57	A-21808	#555	24-8768	24-8767	LEFT JACKPOT
58	A-21808	#555	24-8768	24-8767	BALCONY
61	A-22243	#555	24-8768	24-8767	ULTIMATE CHALLENGE
62	A-22243	#555	24-8768	24-8767	POKER NIGHT
63	A-22243	#555	24-8768	24-8767	EXTRA BALL
64	A-22243	#555	24-8768	24-8767	SPITTING GALLERY
65	A-22243	#555	24-8768	24-8767	LEFT START FIGHT
66	A-17807	#44	24-6549	Not Sold Separate	THE CORNER
67	A-17385	#44	24-6549	Not Sold Separate	RIGHT RETURN
68	A-17385	#44	24-6549	Not Sold Separate	RIGHT SECOND WIND
71	A-22192	#555	24-8768	24-8767	RAID
72	A-22192	#555	24-8768	24-8767	FISTICUFF
73	A-22192	#555	24-8768	24-8767	MULTIBRAWL
74	A-22192	#555	24-8768	24-8767	THREE BANK TOP
75	A-22192	#555	24-8768	24-8767	THREE BANK MIDDLE
76	A-22192	#555	24-8768	24-8767	THREE BANK BOTTOM
77	A-17835	#44	24-6549	Not Sold Separate	LEFT RETURN
78	A-17835	#44	24-6549	Not Sold Separate	LEFT KO
81	A-17835	#44	24-6549	Not Sold Separate	RIGHT KO
82	A-17835	#44	24-6549	Not Sold Separate	LEFT SECOND WIND
83	A-17835	#44	24-6549	Not Sold Separate	TOP BLUE ARROW
84	A-17835	#44	24-6549	Not Sold Separate	CENTER KO
85	A-17807	#44	24-6549	Not Sold Separate	BALL SAVE POST
86	A-17835	#44	24-6549	Not Sold Separate	SHOOT AGAIN
87	20-9663-B-4	----	----	----	LAUNCH BUTTON
88	20-9663-16	----	----	----	START BUTTON

Lamp Locations

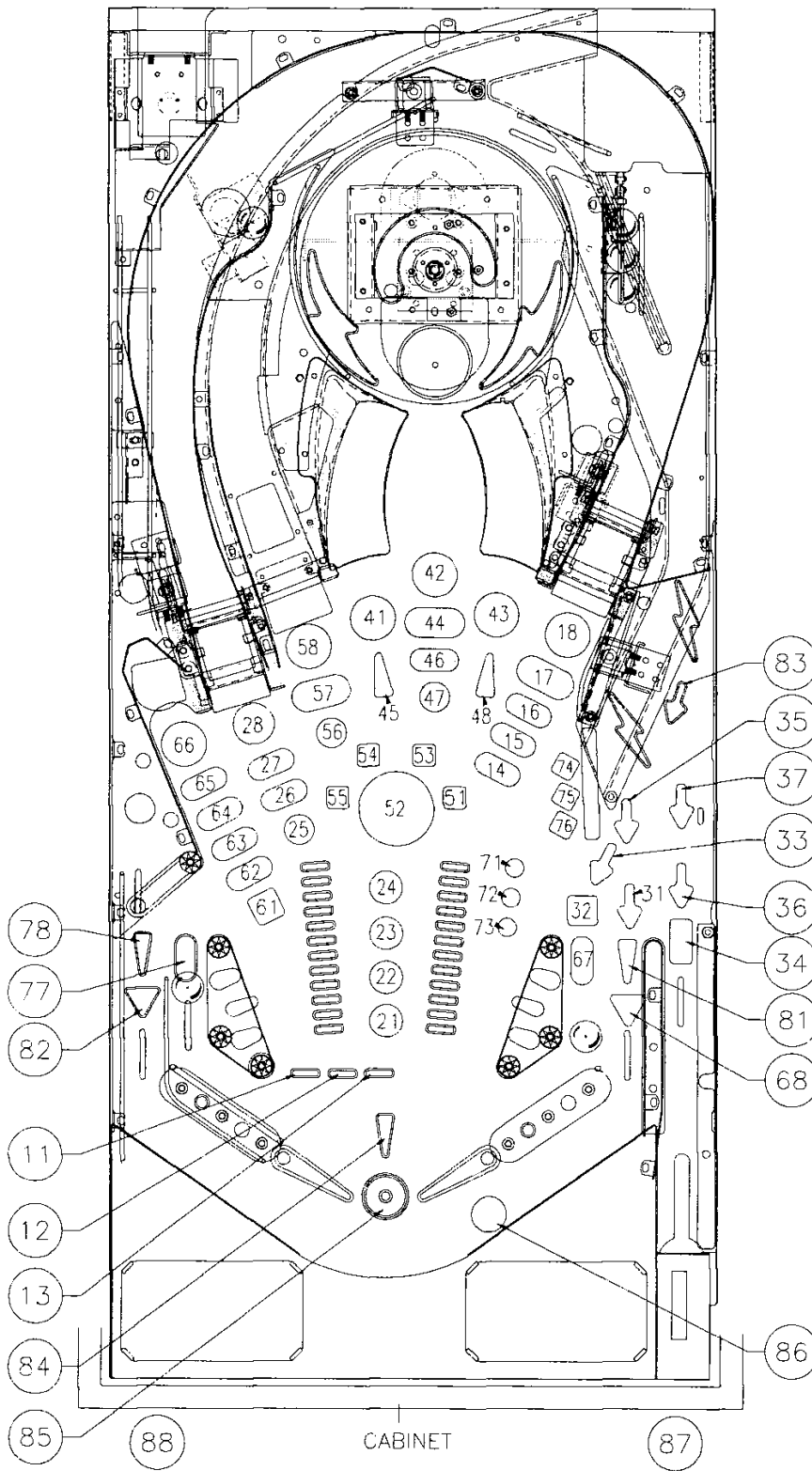

Switch Locations

Item Number	Switch Assembly Part Number <i>OR</i> Opto Assembly Part Number	Switch Part Number	Description
F1	-----	SW-1A-194	*LOWER RIGHT FLIPPER E.O.S.
F2	A-17316	-----	*LOWER RIGHT FLIPPER CABINET
F3	-----	SW-1A-194	*LOWER LEFT FLIPPER E.O.S.
F4	A-17316	-----	*LOWER LEFT FLIPPER CABINET
F5	NOT USED	-----	UPPER RIGHT FLIPPER E.O.S.
F6	NOT USED	-----	UPPER RIGHT FLIPPER CABINET
F7	NOT USED	-----	UPPER LEFT FLIPPER E.O.S.
F8	NOT USED	-----	UPPER LEFT FLIPPER CABINET
11	-----	5647-12693-13	MADE RAMP
12	A-11177	-----	HEAVY BAG
13	20-9663-16	-----	START BUTTON
14	-----	04-10346	*PLUMB BOB TILT
15	B-13289	5647-12693-34	LOCK UP 1
16	A-17813-1	5647-12693-19	LEFT OUTLANE
17	A-17813	5647-12693-19	RIGHT RETURN
18	-----	5647-12133-12	SHOOTER LANE
21	A-17238	-----	*SLAM TILT
22	-----	5643-09268-00	*COIN DOOR CLOSED
23	20-9663-B-4	-----	BALL LAUNCH
24	-----	5643-15190-00	*ALWAYS CLOSED
25	A-22252	A-22253-6	THREE BANK MIDDLE
26	A-17813-1	5647-12693-19	LEFT RETURN
27	A-17813-1	5647-12693-19	RIGHT OUTLANE
28	A-22169 (SEE NOTE 1)	5647-12693-11	POPPER
31	A-18617-1 (LED) A-18618-1 (PHOTO TRANS)	-----	TROUGH ELECT
32	A-18617-1 (LED) A-18618-1 (PHOTO TRANS)	-----	TROUGH BALL 1
33	A-18617-1 (LED) A-18618-1 (PHOTO TRANS)	-----	TROUGH BALL 2
34	A-18617-1 (LED) A-18618-1 (PHOTO TRANS)	-----	TROUGH BALL 3
35	A-18617-1 (LED) A-18618-1 (PHOTO TRANS)	-----	TROUGH BALL 4
36	A-16908 (LED) A-16909 (PHOTO TRANS)	-----	LEFT JAB MADE
37	A-22214 (SEE NOTE 1)	5647-12693-11	CORNER EJECT
38	A-16908 (LED) A-16909 (PHOTO TRANS)	-----	RIGHT JAB MADE
41	A-22171 (SEE NOTE 1)	A-22260 (MOTOR 4-OPTO PCB)	BOXER POLE CENTER
42	A-16908 (LED) A-16909 (PHOTO TRANS)	-----	BEHIND LEFT SCOOP
43	A-16908 (LED) A-16909 (PHOTO TRANS)	-----	BEHIND RIGHT SCOOP
44	A-22189	A-16908 (LED) A-16909 (PHOTO TRANS)	ENTER RAMP
45	A-16908 (LED) A-16909 (PHOTO TRANS)	-----	JUMP ROPE
46	A-22171 (SEE NOTE 1)	A-22260 (MOTOR 4-OPTO PCB)	BAG POLE CENTER
47	A-22171 (SEE NOTE 1)	A-22260 (MOTOR 4-OPTO PCB)	BOXER POLE RIGHT
48	A-22171 (SEE NOTE 1)	A-22260 (MOTOR 4-OPTO PCB)	BOXER POLE LEFT
51	A-17801	A-17800 (KICK) A-17794 (SCORE)**	LEFT SLINGSHOT
52	A-17801	A-17800 (KICK) A-17794 (SCORE)**	RIGHT SLINGSHOT
53	A-22252	A-22253-6	THREE BANK BOTTOM
54	A-22252	A-22253-6	THREE BANK TOP
55	A-17795-6	-----	LEFT HALF GUY
56	A-17795-6	-----	RIGHT HALF GUY
57	B-13289	5647-12693-33	LOCK UP 2
58	B-13289	5647-12693-32	LOCK UP 3
61	A-22176 (SEE NOTE 1)	5647-12693-36	LEFT SCOOP UP
62	A-22176 (SEE NOTE 1)	5647-12693-36	RIGHT SCOOP UP
63	A-17813-1	5647-12693-19	THROWN TOWEL
64	A-22147 (SEE NOTE 1)	A-20533.1-1 (POSITION ENCODER PCB)	ROPE CAM

Switch Locations

Item Number	Switch Assembly Part Number <i>OR</i> Opto Assembly Part Number	Switch Part Number	Description
65	A-22148 (SEE NOTE 1)	SW-1A-215	SPEED BAG
66	A-11177	-----	BOXER GUT 1
67	A-11177	-----	BOXER GUT 2
68	SW-1A-216-3	-----	BOXER HEAD
71	A-22179	5647-12693-17	EXIT ROPE
72	-----	5647-12693-13	ENTER SPEED BAG
73	A-22168	5647-12693-11	DANGER ZONE
74	A-22220 (SEE NOTE 1)	A-16443	ENTER LOCKUP
75	A-22173 (SEE NOTE 1)	5647-12693-11	UP/DOWN POST
76	-----	5647-12693-13	TOP OF RAMP
77	-----	-----	NOT USED
78	A-22220 (SEE NOTE 1)	A-16443	ENTER ROPE
81 TO 88	-----	-----	NOT USED

*NOT SHOWN. **SCORE SWITCHES HAVE DIODES ATTACHED.

NOTE 1: THIS IS THE COMPLETE MECHANICAL ASSEMBLY PART NUMBER, NOT A SWITCH ASSEMBLY PART NUMBER.

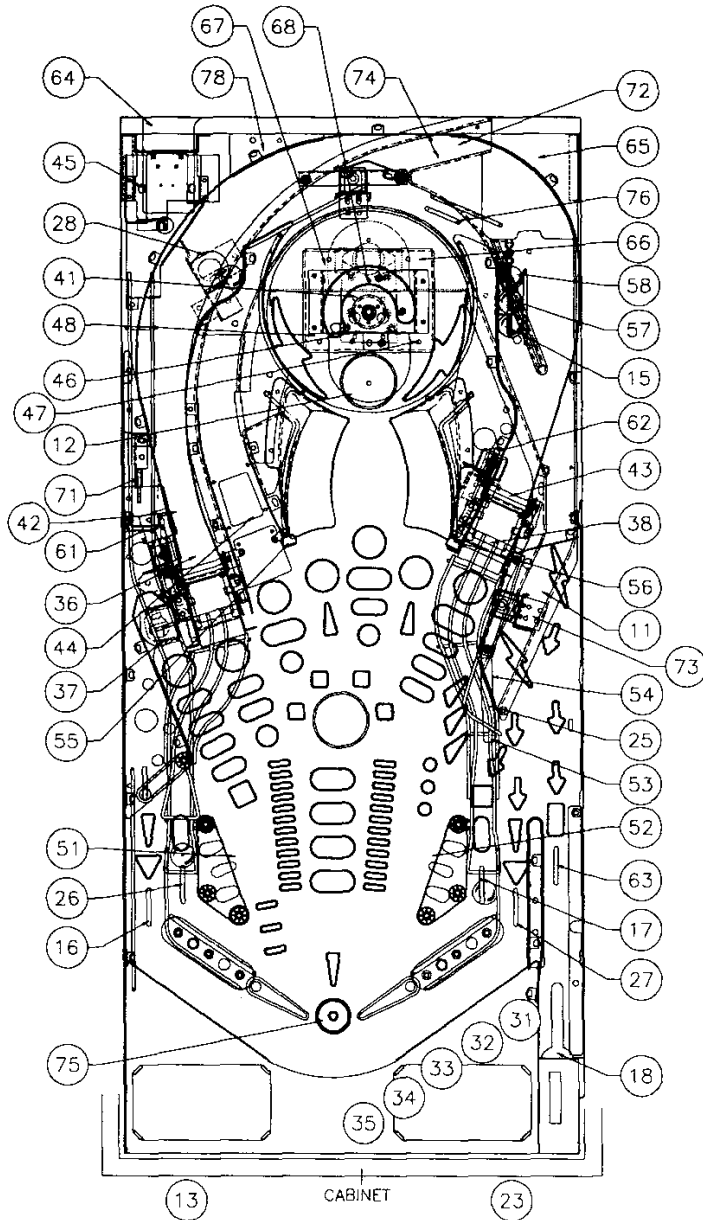

Solenoid/Flashlamp Locations

Item Number	Assembly Part Number	Coil or Flasher Part Number	Description
01	A-16757-2	AE-26-1200	AUTO PLUNGER
02	A-19963	AE-26-1500	TROUGH EJECT
03	A-22176	FL-22241	LEFT SCOOP POWER
04	A-22176	FL-22241	RIGHT SCOOP POWER
05	A-22214	AE-30-2000	CORNER KICKOUT
06	A-22173	FL-22241	POST POWER
07	A-22147	20-10197	ROPE MAGNET
08	A-22167	AE-27-1200	POST DIVERTER
09	A-22176	FL-22241	LEFT SCOOP HOLD
10	A-22176	FL-22241	RIGHT SCOOP HOLD
11	A-22177	04-11000	RIGHT ARM
12	A-22173	FL-22241	POST HOLD
13	A-22177	04-11000	LEFT ARM
14	A-22169	AE-27-1200	POPPER
15	A-22206-2	AE-26-1200	LEFT SLINGSHOT
16	A-22206-2	AE-26-1200	RIGHT SLINGSHOT
17	04-11152.1-12 (2), A-17802 (1)	#906 (3)	BOXER FLASHER
18	A-17802 (2)	#906 (2)	DANGER ZONE FLASHER
19	A-22267-4 (1)	#906 (1)	JUMP ROPE FLASHER
19	-----	#906 (1)	INSERT PANEL FLASHER
20	A-22267-2 (1)	#906 (1)	LOCK KICKOUT FLASHER
20	-----	#906 (1)	INSERT PANEL FLASHER
21	A-22267-1 (1)	#906 (1)	LEFT KICKOUT FLASHER
21	-----	#906 (2)	INSERT PANEL FLASHER
22	A-17802 (2)	#906 (2)	BOXER FLASHER
22	-----	#906 (1)	INSERT PANEL FLASHER
23	04-11152.1-16	#906 (1)	JUMP ROPE FLASHER
24	04-11152.1-16	#906 (1)	SPEED BAG FLASHER
25	A-22147	SEE NOTE 1	ROPE MOTOR
26	A-22171	SEE NOTE 2	TOGGLE DIRECTION
27	A-22171	SEE NOTE 2	MOTOR ON/OFF
28	A-22221	AE-26-1500	LOCK PIN

Flippers

Item	Assembly Part Number	Coil Part Number	Description
29-30	A-15849-R-4	FL-15411	LOWER RIGHT FLIPPER
31-32	A-15849-L-4	FL-15411	LOWER LEFT FLIPPER
33	A-22147	AE-30-2000	ROPE POPPER
34	A-22172	AE-26-1500	RAMP DIVERTER
35	A-22148	AE-27-1200	LEFT SPEED BAG
36	A-22148	AE-27-1200	RIGHT SPEED BAG

24 LED Circuits (SEE NOTE 3)

Item	Driver Board	LED Board	Description
37	A-21967-2	A-21991	
38	A-21967-2	A-21991	
39	A-21967-2	A-21991	
40	A-21967-2	A-21991	

General Illumination

Item	Bulb Number	Bulb Type	Description
01	24-8768	#555	ILLUMINATION STRING 1
02	24-8768	#555	ILLUMINATION STRING 2
03	24-6549	#44	ILLUMINATION STRING 3
04	24-6549	#44	ILLUMINATION STRING 4
05	24-6549	#44	ILLUMINATION STRING 5

24-6549 = #44 Bulb	24-8802 = #906 Bulb
24-8768 = #555 Bulb	

NOTE 1: Solenoid 25, Rope Motor, uses a Motor EMI board, p/n A-15542 (Qty. 1), and a motor, p/n 14-8038 (Qty. 1).

NOTE 2: Solenoid 26 Toggle Direction, and solenoid 27 Motor On/Off, work in tandem and use a TTL Bi-direct Motor board, p/n A-22013 (Qty. 1), and a motor, p/n 14-8036 (Qty.1).

NOTE 3: The 24 LED Display uses two boards:

The Serial 24 Driver Board, part number A-21967-2 (Qty. 1), and the 24 LED Assembly, part number A-21991 (Qty. 2)

Solenoid/Flashlamp Locations

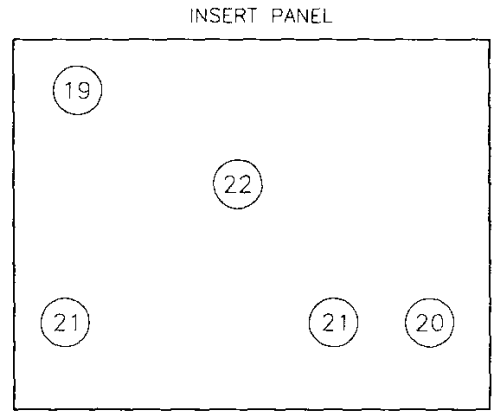
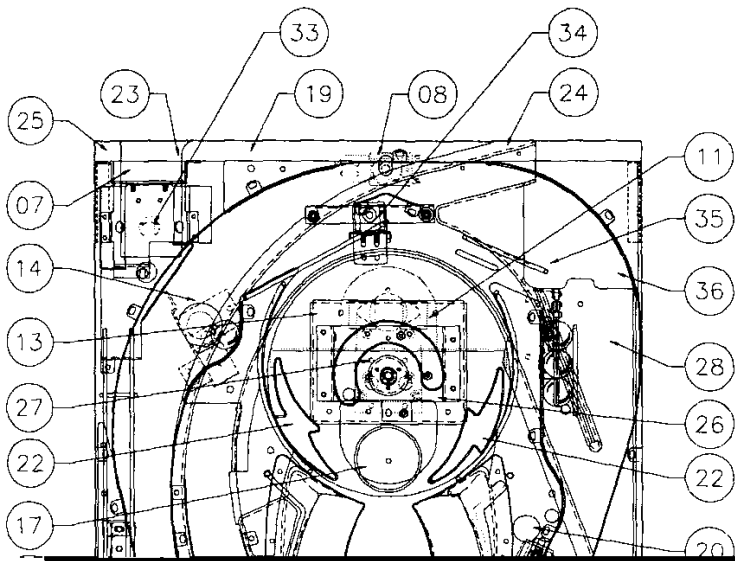

Upper Playfield Parts

Item Number	Part Number	Description	Not Shown: Part Number	Description
1	A-19963	Ball Trough Assembly	A-13204-50063	Bottom Arch Assembly
2	A-16757-2	Catapult Assembly	A-22220	Rollover Button
3	A-15849-R-4 20-10110-6	Flipper Coil - Orange Flipper Bat & Shaft	01-12624	Lower Arch Mounting Bracket
4	12-7402.2	Launch Ramp	01-14776	Left Steel Rail
5	A-17811 A-17801 A-22206-2	Kicker Slingshot Assembly Kicker Switch Assembly Coil & Bracket Assembly	01-14777	Right Steel Rail
6	A-22252	3-bank Standup Target	31-1357-50063	Screened Backglass
7	A-22145	Main Ramp		
8	A-22168 12-7405	One Way Gate Assembly Gate Wire		
9	12-7401	Right Ramp		
10	A-17795-6	Yellow Standup Target		
11	A-22245 A-22175 A-22176	Right Scoop Assembly Up/Down Ball Scoop Scoop Actuator		
12	A-22154	Right Punch Ramp		
13	A-22170 A-22177 A-22263 A-22171	Boxer/Heavy Bag Assembly Boxer Assembly Heavy Bag Assembly Boxer Motor Assembly		
14	A-22254 B-13289	3-bank Micro Switch Assy 3-Bank Switch & Bracket		
15	A-22148	Speed Bag Assembly		
16	A-22172 01-14766	Ramp Diverter Assembly Diverter Blade		
17	A-22167	Up/Down Post Diverter		
18	A-22146	Back Panel Assembly		
19	NOT USED			
20	A-22147	Jump Rope Assembly		
21	A-22169	Popper Assembly		
22	A-22153	Left Punch Ramp		
23	A-22246 A-22175 A-22176	Left Scoop Assembly Up/Down Ball Scoop Scoop Actuator		
24	A-17795-6	Yellow Standup Target		
25	A-22214	Eject Popper Assembly		
26	12-7400.1	Left Wire Ramp		
27	01-14775	Ball Guide #5		
28	A-17811 A-17801 A-22206-2	Kicker Slingshot Assembly Kicker Switch Assembly Coil & Bracket Assembly		
29	A-15849-L-4 20-10110-6	Flipper Coil - Orange Flipper Bat & Shaft		
30	A-22173	Ball Save Post		
31	A-22221	Disappearing Post Assy		
32	01-14771	Ball Guide #1		
33	01-14773	Ball Guide #3		
34	01-14778	Ball Guide #6		
35	01-14772	Ball Guide #2		

*The *Champion Pub* hardcoat playfield does not require a full Mylar. However, mylars can be purchased through your local WILLIAMS Distributor.

Upper Playfield Parts Locations

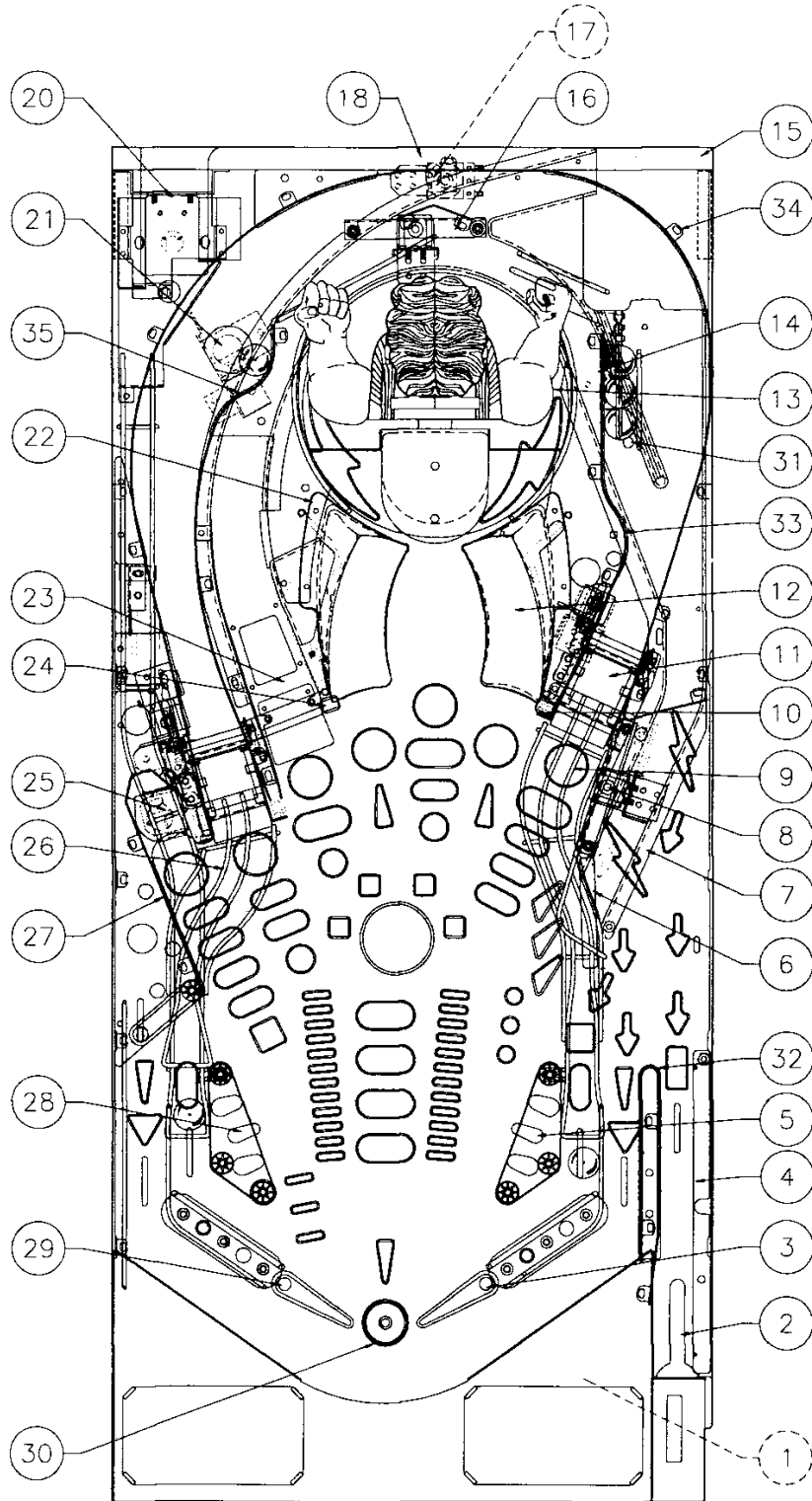

Lower Playfield Parts

Item	Part Number	Description
1	01-11781	Support Bracket (2)
2	A-16757-2	Catapult Assembly
3	A-19963	Ball trough Assembly
4	A-15849-R-4	Flipper Assembly Complete
5	A-22206-2	Coil & Bracket Assembly (2)
6	A-22195	7-Lamp PCB Assembly
7	A-22192	3-Lamp PCB Assembly
8	A-21991-1	24 LED PCB Assembly (2)
9	A-22194	4-Lamp PCB Assembly
10	A-22196	5-Lamp PCB Assembly
11	A-22201	8-Lamp PCB Assembly
12	A-22193	6-Lamp PCB Assembly
13	A-22202	4-Lamp PCB Assembly
14	A-21808	3-Lamp PCB Assembly (2)
15	A-22243	5-Lapm PCB Assembly
16	A-22176	Scoop Actuator Assembly (2)
17	A-22221	Disappearing Post Assembly
18	A-22019-2	16-Opto PCB Assembly
19	A-22171	Boxer Motor Assembly
20	A-22172	Ramp Diverter Assembly
21	A-22167	Up/Down Post Diverter Assy.
22	A-15542	Motor EMI Assembly
23	A-22169	Popper Assembly
24	A-17749.1-2	Slide Playfield Assembly, Right
25	A-17749.1-1	Slide Playfield Assembly, Left
26	A-21967-2	Serial 24 Driver PCB Assembly
27	A-22214	Eject Popper Assembly
28	A-15849-L-4	Flipper Assembly Complete
29	A-22173	Ball Save Post Assembly

Lower Playfield Parts Locations

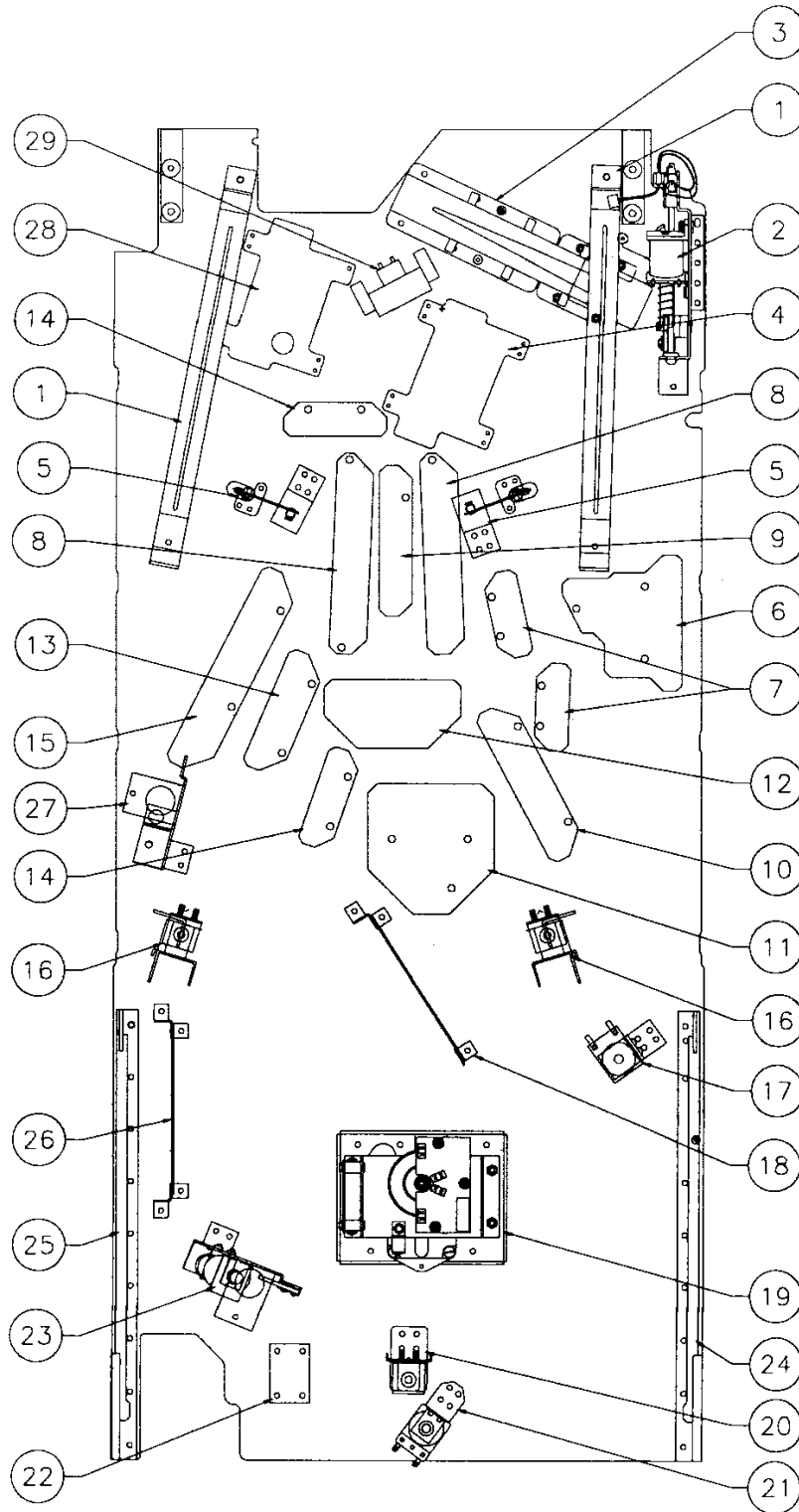

(Underside of Playfield, Viewed in Raised Position)

LED LIST

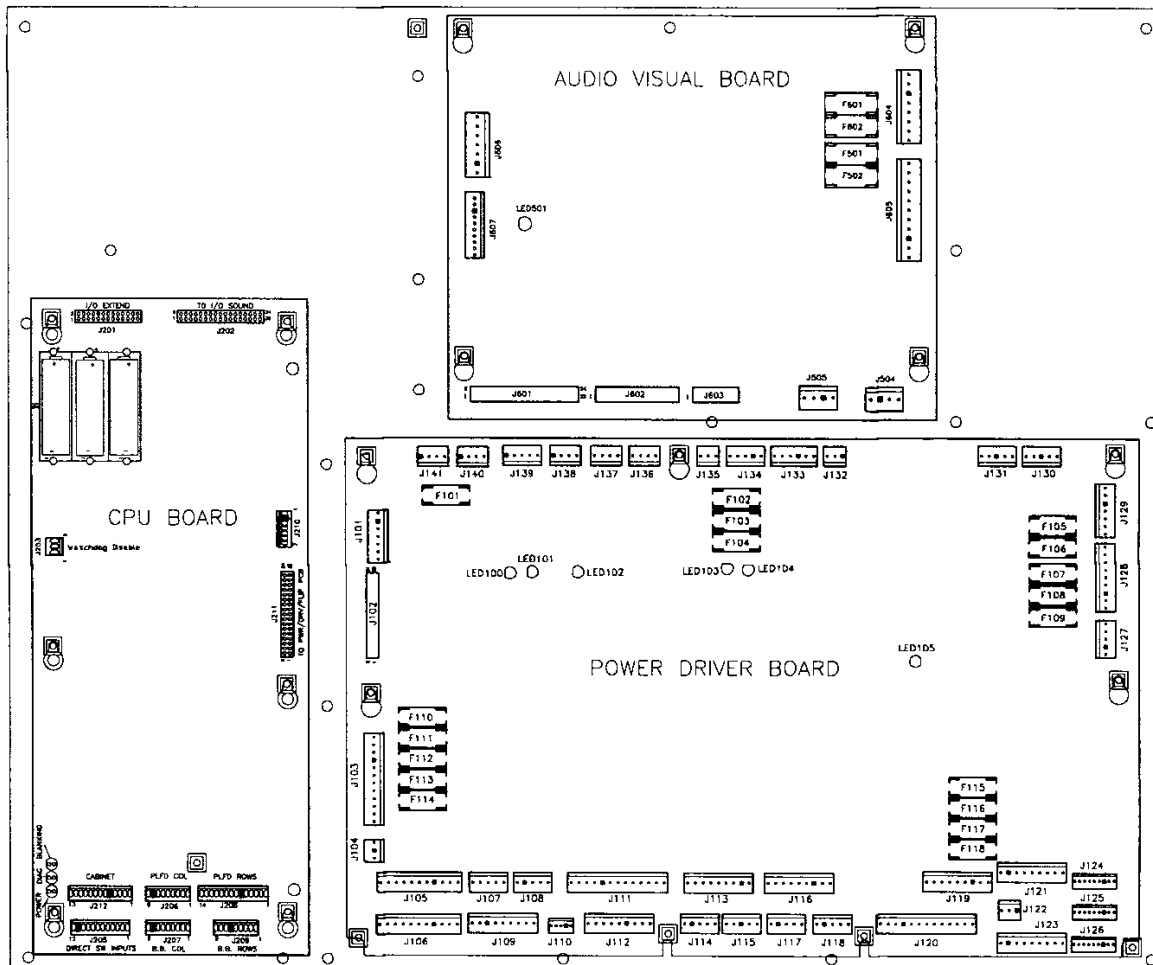

CPU BOARD

- LED 201 Blanking
- LED 202 Power
- LED 203 Diagnostics

At game turn-on, LED 201 and LED 202 are on, LED 203 is off. During normal operation LED 201 is off, LED 202 is on, and LED 203 is flashing.

AUDIO VISUAL BOARD

- LED 501 +5VDC, Normally flashing, but at a slower rate than LED 203.

POWER DRIVER BOARD

- LED 100 +12VDC Regulated, Normally On
- LED 101 +5VDC Digital, Normally On
- LED 102 +18VDC Lamps, Normally On
- LED 103 +12VDC Unregulated, Normally On
- LED 104 +20VDC Flashlamps, Normally On
- LED 105 +50VDC Coils, Normally On

FUSE LIST

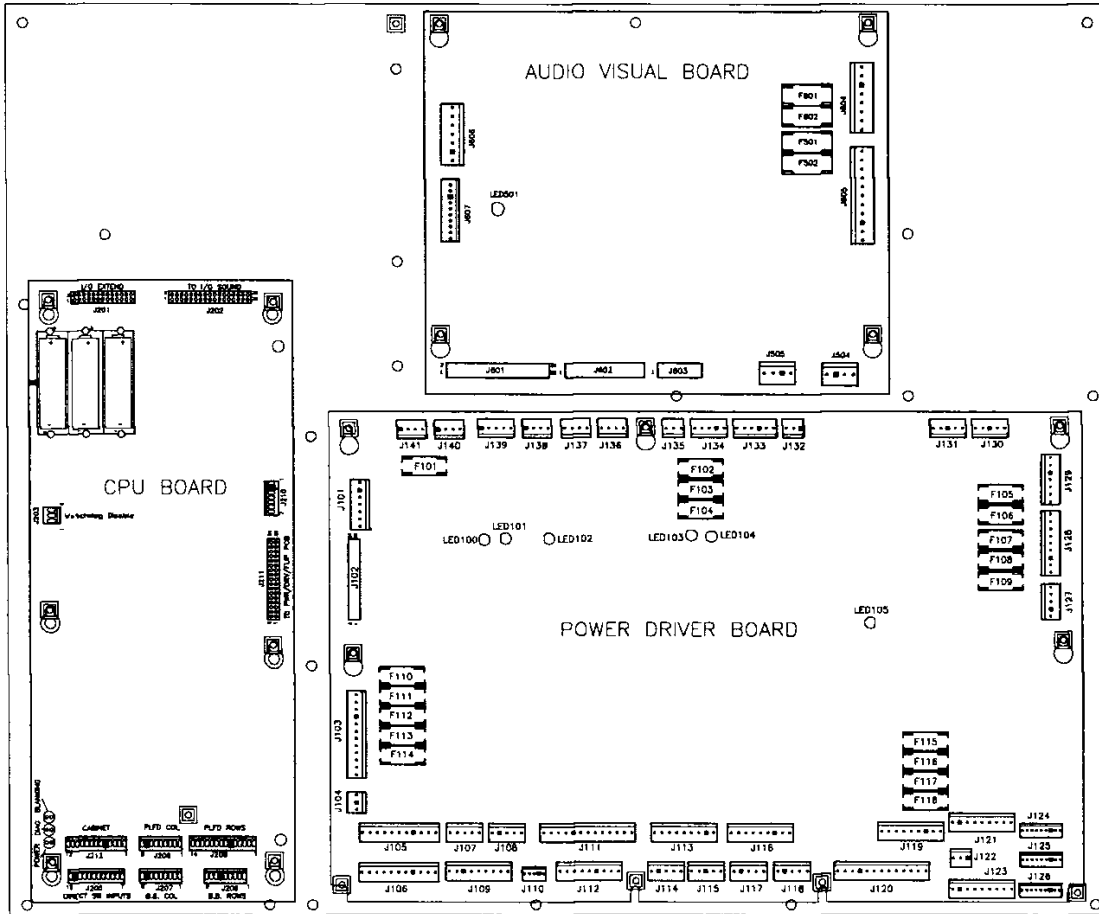

AUDIO VIDEO BOARD

Loc.	Description	Part Number	Value
F501	-25V	5731-14532-00	T2.5A, 250V
F502	+25V	5731-14532-00	T2.5A, 250V
F601	+62V	5731-14533-00	T0.315A, 250V
F602	-113V & -125V	5731-14533-00	T0.315A, 250V

CPU BOARD

There are no fuses on the CPU board.

POWER DRIVER BOARD

Loc.	Description	Part Number	Value	Loc.	Description	Part Number	Value
F101	Regulated 12V	5731-14531-00	T0.63A, 250V	F110	G.I. #5 WHT-VIO	5731-14530-00	T4.0A, 250V
F102	Solenoid. #25 to #28	5731-14530-00	T4.0A, 250V	F111	G.I. #4 WHT-GRN	5731-14530-00	T4.0A, 250V
F103	Solenoid #1-#8	5731-14530-00	T4.0A, 250V	F112	G.I. #3 WHT-YEL	5731-14530-00	T4.0A, 250V
F104	Solenoid #9 to #16	5731-14530-00	T4.0A, 250V	F113	G.I. #2 WHT-ORG	5731-14530-00	T4.0A, 250V
F105	+5V Logic	5731-14530-00	T4.0A, 250V	F114	G.I. #1 WHT-BRN	5731-14530-00	T4.0A, 250V
F106	+18V Lamp Matrix	5731-14046-00	T5.0A, 250V	F115	+50V Flippers	5731-14530-00	T4.0A, 250V
F107	Flasher Secondary	5731-14530-00	T4.0A, 250V	F116	+50V Flippers	5731-14530-00	T4.0A, 250V
F108	Solenoid Secondary	5731-14529-00	T6.3A, 250	F117	+50V Flippers	5731-14530-00	T4.0A, 250V
F109	Unregulated 12V	5731-14530-00	T4.0A, 250V	F118	+50V Flippers	5731-14530-00	T4.0A, 250V

LINE FILTER

Loc.	Part Number	Value
Foreign	5731-14530-00	T4.0A, 250V
Domestic	5731-14046-00	T5.0A, 250V

LAMP MATRIX

Yellow (B+)



Red

Column Row	1 Yellow-Brown J121-1 Q96	2 Yellow-Red J121-2 Q100	3 Yellow-Orange J121-3 Q95	4 Yellow-Black J121-4 Q99	5 Yellow-Green J121-5 Q94	6 Yellow-Blue J121-6 Q98	7 Yellow-Violet J121-7 Q93	8 Yellow-Gray J121-9 Q97
1 Red-Brown J125-1 Q104	HEAVY BAG COMPLETE 11	BOUT 1 21	LOWER BLUE ARROW 31	LEFT HOOK 41	JACKPOTS COMPLETE 51	ULTIMATE CHALLENGE 61	RAID 71	RIGHT KO 81
2 Red-Black J125-2 Q108	JUMP ROPE COMPLETE 12	BOUT 2 22	LEFT HOOK TO WIN 32	BODY BLOW 42	PUB CHAMPION 52	POKER NIGHT 62	FISTICUFF 72	LEFT SECOND WIND 82
3 Red-Orange J125-4 Q103	SPEED BAG COMPLETE 13	BOUT 3 23	WHITE ARROW 33	RIGHT HOOK 43	WON BY KO 53	EXTRA BALL 63	MULTIBRAWL 73	TOP BLUE ARROW 83
4 Red-Yellow J125-5 Q107	RIGHT JAB COMBO 14	BOUT 4 24	THROWN TOWEL 34	CENTER JACKPOT 44	MULTIBALLS COMPLETE 54	SPITTING GALLERY 64	THREE BANK TOP 74	CENTER KO 84
5 Red-Green J125-6 Q102	LOCK 15	JUMP ROPE 25	CENTER BLUE ARROW 35	LEFT KO BOXER 45	TRAINING COMPLETE 55	LEFT START FIGHT 65	THREE BANK MIDDLE 75	BALL SAVE POST 85
6 Red-Blue J125-7 Q106	RIGHT START FIGHT 16	LEFT JAB COMBO 26	LOWER YELLOW ARROW 36	HURRY-UP 46	SPEED BAG 56	THE CORNER 66	THREE BANK BOTTOM 76	SHOOT AGAIN 86
7 Red-Violet J125-8 Q101	RIGHT JACKPOT 17	CENTER START FIGHT 27	TOP YELLOW ARROW 37	HEAVY BAG 47	LEFT JACKPOT 57	RIGHT RETURN 67	LEFT RETURN 77	LAUNCH BUTTON 87
8 Red-Gray J125-9 Q105	RIGHT JAB 18	LEFT JAB 28	NOT USED 38	RIGHT KO BOXER 48	BALCONY 58	RIGHT SECOND WIND 68	LEFT KO 78	START BUTTON 88

J1XX = Power Driver Board

SWITCH MATRIX

White  Green

DEDICATED GROUNDED SWITCHES	Column		1	2	3	4	5	6	7	8	FLIPPER GROUNDED SWITCHES
	Row		Green-Brown J206-1 U20-18	Green-Red J206-2 U20-17	Green-Orange J206-3 U20-16	Green-White J206-4 U20-15	Green-Black J206-5 U20-14	Green-Blue J206-6 U20-13	Green-Violet J206-7 U20-12	Green-Gray J206-9 U20-11	
Orange-Brown J205-1 LEFT COIN CHUTE U17-5 D1	1	White-Brown J208-1 U18-11	MADE RAMP 11	SLAM TILT 21	TROUGH EJECT 31	BOXER POLE CENTER 41	LEFT SLINGSHOT 51	LEFT SCOOP UP 61	EXIT ROPE 71	NOT USED 81	BLACK-GREEN J208-13 LOWER RIGHT FLIPPER E.O.S. F1
Orange-Red J205-2 CENTER COIN CHUTE U17-7 D2	2	White-Red J208-2 U18-9	HEAVY BAG 12	COIN DOOR CLOSED 22	TROUGH BALL 1 32	BEHIND LEFT SCOOP 42	RIGHT SLINGSHOT 52	RIGHT SCOOP UP 62	ENTER SPEED BAG 72	NOT USED 82	BLACK-VIOLET J212-12 LOWER RIGHT FLIPPER OPTO F2
Orange-Black J205-3 RIGHT COIN CHUTE U17-11 D3	3	White-Orange J208-3 U18-5	START BUTTON 13	BALL LAUNCH 23	TROUGH BALL 2 33	BEHIND RIGHT SCOOP 43	THREE BANK BOTTOM 53	THROWN TOWEL 63	DANGER ZONE 73	NOT USED 83	BLACK-BLUE J208-12 LOWER LEFT FLIPPER E.O.S. F3
Orange-Yellow J205-4 4TH COIN CHUTE U17-9 D4	4	White-Yellow J208-4 U18-7	PLUMB BOB TILT 14	ALWAYS CLOSED 24	TROUGH BALL 3 34	ENTER RAMP 44	THREE BANK TOP 54	ROPE CAM 64	ENTER LOCK UP 74	NOT USED 84	BLACK-GRAY J212-11 LOWER LEFT FLIPPER OPTO F4
Orange-Green J205-6 Normal Function Test Function Srv Crsts Escape D5	5	White-Green J208-5 U19-11	LOCK UP 1 15	THREE BANK MIDDLE 25	TROUGH BALL 4 35	JUMP RAMP 45	LEFT HALF GUY 55	SPEED BAG 65	UP/DOWN POST 75	NOT USED 85	BLACK-VIOLET J208-11 UPPER RIGHT FLIPPER E.O.S. F5
Orange-Blue J205-7 Normal Function Test Function Volume Dn Down D6	6	White-Blue J208-7 U19-9	LEFT OUTLANE 16	LEFT RETURN 26	LEFT JAB MADE 36	BAG POLE CENTER 46	RIGHT HALF GUY 56	BOXER GUT 1 66	TOP OF RAMP 76	NOT USED 86	BLACK-YELLOW J212-10 UPPER RIGHT FLIPPER OPTO F6
Orange-Violet J205-8 Normal Function Test Function Volume Up Up D7	7	White-Violet J208-8 U19-5	RIGHT RETURN 17	RIGHT OUTLANE 27	CORNER EJECT 37	BOXER POLE RIGHT 47	LOCK UP 2 57	BOXER GUT 2 67	NOT USED 77	NOT USED 87	BLACK-GRAY J208-10 UPPER LEFT FLIPPER E.O.S. F7
Orange-Gray J205-9 Normal Function Test Function Begin Test Enter D8	8	White-Gray J208-9 U19-7	SHOOTER LANE 18	POPPER 28	RIGHT JAB MADE 38	BOXER POLE LEFT 48	LOCK UP 3 58	BOXER HEAD 68	ENTER ROPE 78	NOT USED 88	BLACK-BLUE J212-9 UPPER LEFT FLIPPER OPTO F8

J2XX = CPU BOARD

 = OPTO, TYPICALLY CLOSED

SOLENOID/FLASHER TABLE

Sol. No.	Function	Solenoid Type	Voltage Connections			Drive Xistor	Drive Connections			Drive Wire Color	Solenoid Part Number	
			Playfield	Insert	Cabinet		Playfield	Insert	Cabinet		Flashlamp Type	Playfield
01	AUTO PLUNGER	High Power	J133-2			Q72	J116-1			VIO-BRN	AE-26-1200	
02	TROUGH EJECT	High Power	J133-2			Q68	J116-2			VIO-RED	AE-26-1500	
03	LEFT SCOOP POWER	High Power	J133-2			Q71	J116-4			VIO-ORG	FL-22241	
04	RIGHT SCOOP POWER	High Power	J133-2			Q67	J116-5			VIO-YEL	FL-22241	
05	CORNER KICKOUT	High Power	J133-2			Q70	J116-6			VIO-GRN	AE-30-2000	
06	POST POWER	High Power	J133-2			Q66	J116-7			VIO-BLU	FL-22241	
07	ROPE MAGNET	High Power	J133-2			Q69	J116-8			VIO-BLK	20-10197	
08	POST DIVERTER	High Power	J133-2			Q65	J116-9			VIO-GRY	AE-27-1200	
09	LEFT SCOOP HOLD	Low Power	J133-2			Q44	J113-1			BRN-BLK	FL-22241	
10	RIGHT SCOOP HOLD	Low Power	J133-2			Q48	J113-3			BRN-RED	FL-22241	
11	RIGHT ARM	Low Power	J133-3			Q43	J113-4			BRN-ORG	04-11000	
12	POST HOLD	Low Power	J133-2			Q47	J113-5			BRN-YEL	FL-22241	
13	LEFT ARM	Low Power	J133-3			Q42	J113-6			BRN-GRN	04-11000	
14	POPPER	Low Power	J133-3			Q46	J113-7			BRN-BLU	AE-27-1200	
15	LEFT SLINGSHOT	Low Power	J133-3			Q41	J113-8			BRN-VIO	AE-26-1200	
16	RIGHT SLINGSHOT	Low Power	J133-3			Q45	J113-9			BRN-GRY	AE-26-1200	
17	BOXER FLASHER (3)	Flasher	J133-6			Q28	J111-1			BLK-BRN	#906 (3)	
18	DANGER ZONE FLASHER (2)	Flasher	J133-6			Q32	J111-2			BLK-RED	#906 (2)	
19	JUMP ROPE FLASHER (2)	Flasher	J133-6	J134-5		Q27	J111-3	J112-3		BLK-ORG	#906 (1)	#906 (1)
20	LOCK KICKOUT (2)	Flasher	J133-6	J134-5		Q31	J111-4	J112-5		BLK-YEL	#906 (1)	#906 (1)
21	LEFT KICKOUT (3)	Flasher	J133-6	J134-5		Q26	J111-5	J112-6		BLU-GRN	#906 (1)	#906 (2)
22	BOXER FLASHER (3)	Flasher	J133-6	J134-5		Q30	J111-6	J112-7		BLU-BLK	#906 (2)	#906 (1)
23	JUMP ROPE FLASHER	Flasher	J133-6			Q25	J111-7			BLU-VIO	#906 (1)	
24	SPEED BAG FLASHER	Flasher	J133-6			Q29	J111-8			BLU-GRY	#906 (1)	
25	ROPE MOTOR	Gen. Purpose	J141-2			Q16	J109-1			BLU-BRN	SEE NOTE 1	
26	TOGGLE DIRECTION	Gen. Purpose	J141-2			Q15	J109-2			BLU-RED	SEE NOTE 2	
27	MOTOR ON/OFF	Gen. Purpose	J141-2			Q14	J109-3			BLU-ORG	SEE NOTE 2	
28	†LOCK PIN	Gen. Purpose	J133-1			Q13	J109-4			BLU-YEL	AE-26-1500	
Flipper Circuits		Solenoid Type	Playfield Voltage Connection	Drive Xistors Power	Hold	Playfield Drive Connections	Drive Wire Colors Power	Hold	Coil Part No.	Coil Colors		
29	LOWER RIGHT FLIPPER	Power	J119-1 (RED-GRN)	Q90		J120-13	YEL-GRN					
30		Hold	J119-1 (RED-GRN)	Q92		J120-11	ORG-GRN		FL-15411	BLU		
31	LOWER LEFT FLIPPER	Power	J119-4 (RED-BLU)	Q87		J120-9	YEL-BLU					
32		Hold	J119-4 (RED-BLU)	Q89		J120-7	ORG-BLU		FL-15411	BLU		
33	ROPE POPPER	Power	J119-6 (RED-VIO)	Q84		J120-6	YEL-VIO		AE-30-2000	VIO		
34	RAMP DIVERTER	Hold	J119-6 (RED-VIO)	Q86		J120-4	ORG-VIO		AE-26-1500	BLU		
35	LEFT SPEED BAG	Power	J119-8 (RED-GRY)	Q81		J120-3	YEL-GRY		AE-27-1200	WHT		
36	RIGHT SPEED BAG	Hold	J119-8 (RED-GRY)	Q83		J120-1	ORG-GRY		AE-27-1200	WHT		
24 LED Display		Solenoid Type	Playfield Voltage Connection	Drive Gates		Playfield Drive Connections	Drive Wire Colors		Device Part Number			
37		Low Power	J138-2	U3A, U3B		J110-1	BRN-WHT		SEE NOTE 3			
38		Low Power	J138-2	U3C, U3D		J110-3	ORG-WHT		SEE NOTE 3			
39		Low Power	J138-2	U3G, U3H		J110-4	YEL-WHT		SEE NOTE 3			
40		Low Power	J138-2	U3E, U3F		J110-5	BLU-WHT		SEE NOTE 3			
General Illumination		Solenoid Type	Voltage Connections			Drive Xistor	Drive Connections			Drive Wire Color	Bulb Type	
			Playfield	Insert	Cabinet		Playfield	Insert	Cabinet		Playfield	Insert
01	ILLUMINATION STRING 1	G.I.		J106-1		Q5		J106-7		WHT-BRN		#555
02	ILLUMINATION STRING 2	G.I.		J106-2		Q4		J106-8		WHT-ORG		#555
03	ILLUMINATION STRING 3	G.I.	J105-3			Q3	J105-9			WHT-YEL	#44	
04	*ILLUMINATION STRING 4	G.I.	J105-5			Q2	J105-10			WHT-GRN	#44	
05	*ILLUMINATION STRING 5	G.I.	J105-6		J104-3	Q1	J105-11		J104-1	WHT-VIO	#44	

*These general illumination strings do not brighten and dim, they are always on.

24-6549 =	#44 bulb	24-8768 =	#555 bulb
24-8704 =	#89 bulb	24-8802 =	#906 bulb

†The tieback diode for solenoid 28, Lock Pin, is at J109-9.

NOTE 1: Solenoid 25, Rope Motor, uses a Motor EMI board, p/n A-15542 (Qty. 1), and a motor, p/n 14-8038 (Qty. 1).

NOTE 2: Solenoid 26 Toggle Direction, and solenoid 27 Motor On/Off, work in tandem and use a TTL Bi-direct Motor board, p/n A-22013 (Qty. 1), and a motor, p/n 14-8036 (Qty. 1).

NOTE 3: The 24 LED Display uses two boards:

The Serial 24 Driver Board, part number A-21967-2 (Qty. 1), and the 24 LED Assembly, part number A-21991 (Qty. 2)

WARNINGS & NOTICES

WARNING

FOR SAFETY AND RELIABILITY, substitute parts and equipment modifications are not recommended. Use of Non-WILLIAMS parts or modifications of game circuitry, may adversely affect game play, or may cause injuries.

SUBSTITUTE PART OR EQUIPMENT MODIFICATIONS may void FCC/CANADA Type Acceptance.

BECAUSE THIS GAME IS PROTECTED by Federal copyright, trademark, and patent laws, unauthorized game conversions may be illegal under Federal law.

THIS 'CONVERSION' PRINCIPLE ALSO APPLIES to unauthorized facsimiles of WILLIAMS equipment, logos, designs, publications, assemblies, and games (or game features not deemed to be public domain), whether manufactured with WILLIAMS components or not.

NOTICE

WILLIAMS, Lane-change and Multi-ball are trademarks of WILLIAMS ELECTRONICS GAMES, INC. The entire content of this manual is © 1998 WILLIAMS ELECTRONICS GAMES, INC.

WARNING

NOTE: This equipment has been tested and found to comply with the limits for a Class A digital device, pursuant to Part 15 of the FCC Rules. These limits are designed to provide reasonable protection against harmful interference when the equipment is operated in a commercial environment. This equipment generated, uses, and can radiate radio frequency energy and if not installed and used in accordance with the instruction manual, may cause harmful interference to radio communications. Operation of this equipment in a residential area is likely to cause harmful interference in which case the user will be required to correct the interference at his own expense.

This Class B digital apparatus meets all requirements of the Canadian Interference-Causing Equipment Regulations.

Cet appareil numérique de la classe B respecte toutes les exigences du Règlement sur le matériel brouilleur du Canada.

RF Interference Notice

CABLE HARNESS PLACEMENTS and ground strap routing on this game have been designed to keep RF radiation and conduction within levels accepted by the FCC Rules.

TO MAINTAIN THESE LEVELS, reposition harnesses and reconnect ground straps to their original placements, if they become disconnected during maintenance.

FCC/CANADA STICKER: Check the back of your game to verify that an FCC/CANADA certification sticker was attached to your game at the factory. All games that leave the WILLIAMS plant have been tested and found to comply with FCC/CANADA Rules. Because the sticker is proof of this fact, legal repercussions to the owner and distributor may result, if the sticker is missing. If you receive a game that has no FCC/CANADA sticker, call WILLIAMS for advice or write us a note on your Game Registration Card. Be sure that the card bears your game's serial number.

For Service...

Call your authorized Williams Distributor

Williams Electronics Games, Inc.

3401 N. California Avenue
Chicago, IL 60618

©1998 Williams Electronics Games, Inc. All Rights Reserved.

**CAUTION: Transport this Game ONLY
With the Hinged Backbox DOWN!**