



InJoy Motion Corp.

STREET RACING STARS SDX2-1 Service Manual

InJoy – STREET RACING STARS SDX2-1

OPERATOR Service Manual

1. INTRODUCTION	2
2. SPECIFICATIONS.....	3
2.1 INJOY–STREET RACING STARS SDX2-1 MOTION BASE.....	3
3. INSTALLATION	4
3.1 SERVICE KIT	4
3.2 INSTALLATION INSTRUCTIONS	4
3.2.1 PRE-INSTALL PREREQUISITES/CAUTIONS	4
3.2.2 INSTALL LCD MONITOR.....	5
3.2.3 INSTALL SIDE STEPS	6
3.2.4 INSTALL HEAD LAMP	8
3.2.5 SETCOIN ACCEPTOR	8
3.2.7 INSTALL DEBIT CARD.....	10
3.2.7 POWER INPUT.....	11
4. GAME SETTING AND INTRODUCTION	12
4.1 GAME SETTING (OPERATOR MENU)	12
4.1.1 COIN OPTIONS.....	13
4.1.2 GAME OPTIONS	14
4.1.3 PEDAL SETTING	15
4.1.4 LANGUAGE SETTING.....	18
4.1.5 SYSTEM TIME SETTING	18
4.1.6 VOLUME SETTING.....	19
4.1.7 DEVICE TEST.....	19
4.1.8 SOFTWARE UPGRADE.....	20
4.1.9 STATISTIC	23
4.1.10 SAVE & EXIT	24
4.2 GAME INTRODUCTION.....	25
4.2.1 GAME CONTROL.....	25
5. MAINTENANCE.....	26
5.1 CHASSIS ELECTRONIC COMPONENTS	26
5.2 CABINET ELECTRONIC COMPONENTS	27
5.3 COCKPIT ELECTRONIC COMPONENTS.....	28
5.4 MAINTENANCE	29
6. TROUBLE SHOOTING	31



Injoy Motion Corp.

STREET RACING STARS SDX2-1 Service Manual

1. INTRODUCTION

Thank you for purchasing the ***Injoy STREET RACING STARS SDX2-1 “@Motion System”*** developed by ***Injoy*** that are well distributed in many markets and territories. This manual will guide you through the set-up and operation of ***Injoy STREET RACING STARS SDX2-1***, an ultimate game motion system for arcade environments. This unit is different from any other machines of its kind you have ever owned. A fully interactive coin- and swipe card-operated motion simulator, ***Injoy STREET RACING STARS SDX2-1*** creates a virtual reality environment and provides a truly unique game experience for players. Capable of any motion through 2.0 degrees of freedom (also known as D.O.F.) movement (pitch, roll and yaw), this system enables realistic simulation needed for any software program. Rather than pneumatic or hydraulic actuators that require much more maintenance and have been used to power most motion simulators in the past, ***Injoy STREET RACING STARS SDX2-1*** is powered by electric motors and adopts ***IMON’s*** patented design that highlights a powerful, mini-motion based platform with physics-based motion dynamics. Players will experience realism to an extent that they can “feel” all the exciting actions in a synchronized way as they indulge in the game.

IMON/Injoy is devoted to offer you the most advanced cost-economical and rewarding motion arcade system available. You are welcome to contact us for any questions you may have or for any service we can be of.

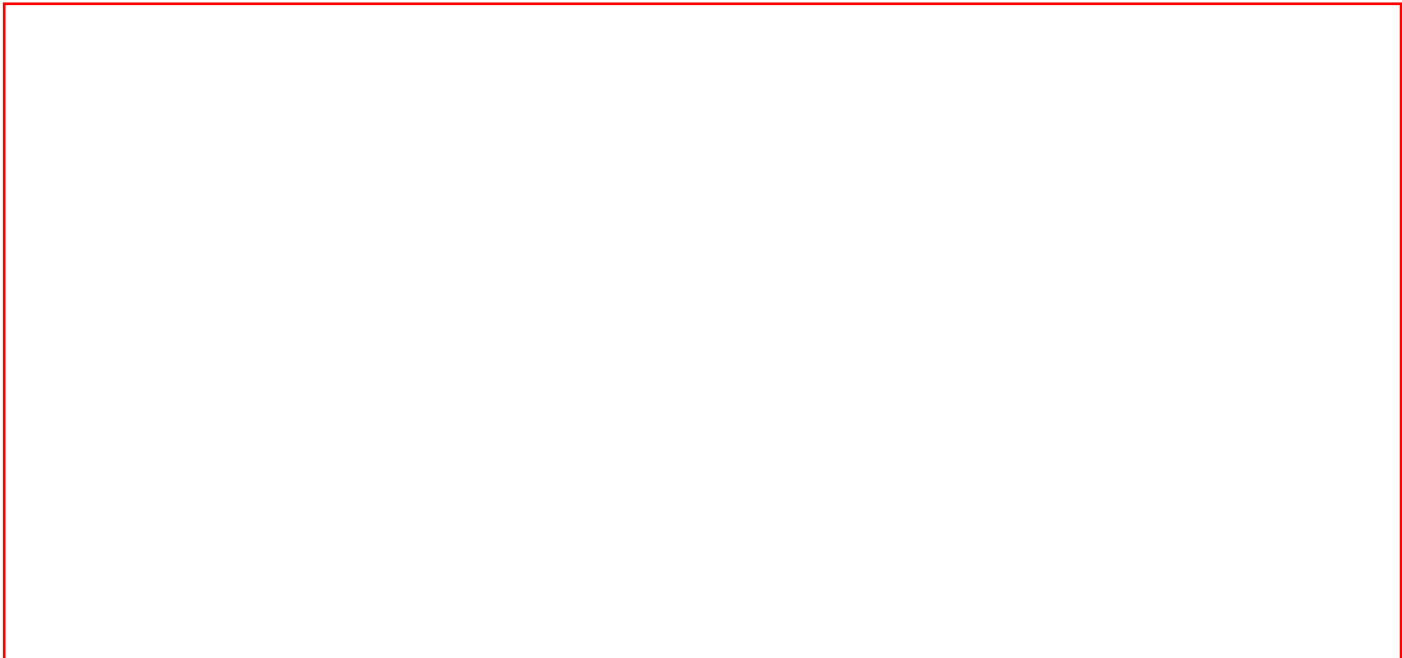



InJoy Motion Corp.

STREET RACING STARS SDX2-1 Service Manual

2. SPECIFICATIONS

An *InJoy- STREET RACING STARS SDX2-1* includes a complete **Motion Base**.

The dimensions given below are *InJoy STREET RACING STARS SDX2-1*'s installed footprint.

InJoy STREET RACING STARS SDX2-1 @Motion System Unit

US & GB: 125.99" x 86.62"

Minimum Installed Footprint

Metric: 320.00cm x 220.00cm

2.1 INJOY-STREET RACING STARS SDX2-1 MOTION BASE

<i>InJoy STREET RACING STARS SDX2-1 Motion Base Simulator (single)</i>		
No	Item	Specification
1	Installed Dimensions / Weight (L x W x H)	<ul style="list-style-type: none"> ● 125.99" x 86.62" x 84.65" ● 320.00 x 220.00 x 215 cm
2	Motion system	<ul style="list-style-type: none"> ● 2.0 degree of freedom (D.O.F.) mini motion base: AC-powered, motor-driven actuators
3	Control Inputs/Feedback	<ul style="list-style-type: none"> ● Steering wheel ● Gear ● Fuel Pedal ● Brake Pedal ● Yellow Button for Start / Turbo ● Red Button for View ● Motion Stop Switch
4	Player Weight Limit	<ul style="list-style-type: none"> ● Max 300 kgs per car
5	Center of Gravity	<ul style="list-style-type: none"> ● Directly over 2 axis
6	Power Requirements – Plugs located at the bottom of the motion base behind the monitor.	<ul style="list-style-type: none"> ● Power requirements in USA: 110 VAC ● Power requirements in Euro: 220 VAC
7	Max Watt Consumed Rated Watt Consumed	<ul style="list-style-type: none"> ● 6820 W ● 5460 W
8	Audio	<ul style="list-style-type: none"> ● 30 watts speakers x 2, 4 ohm ● 1 sub-woofer ● 2 super sub-woofer under seat
9	Monitor	<ul style="list-style-type: none"> ● 52" LCD Monitor ● 15pin DB Connection
10	Computer System	<ul style="list-style-type: none"> ● Windows Embedded Operating System ● High Resolution Graphics Accelerator Card.



Injoy Motion Corp.

STREET RACING STARS SDX2-1 Service Manual

3. INSTALLATION

3.1 SERVICE KIT

The following items should be included with the shipment of your *Injoy STREET RACING STARS SDX2-1*:

Service Kit	
<i>Description</i>	Qty
<i>Injoy-STREET RACING STARS SDX2-1</i> Service Manual	1
Maintenance Box Key	1
Coin Box Key	1
Special Wrench	1

3.2 SET UP INSTRUCTIONS

3.2.1 PRE-INSTALL PREREQUISITES/CAUTIONS

Injoy STREET RACING STARS SDX2-1 is designed for indoor use only. To ensure trouble-free and safe operation, the following conditions are recommended:

1. The motion system must be located out of direct exposure to sunlight, high humidity, dust, salt mist, high heat, or extreme cold. If it is installed in an extremely hot location, allow additional clearance between ventilation slots in the game and any structure or object that would tend to restrict air circulation.
2. The motion system produces tremendous forces onto the motion base, which may be moved around on the floor if not properly installed. Before placing XP360 motion system on the ground, make sure the floor space is flat and before operating the game, make sure the brackets are tightly installed. If you have questions regarding any installation requirements, .contact our tech support (+886-2-2267-6317 Ext. 283 or E-mail: support@imon.com.tw) at *Injoy* before proceeding.



InJoy Motion Corp.

STREET RACING STARS SDX2-1 Service Manual

3.2.2 INSTALL LCD MONITOR

Please install Center Plate by following the steps.

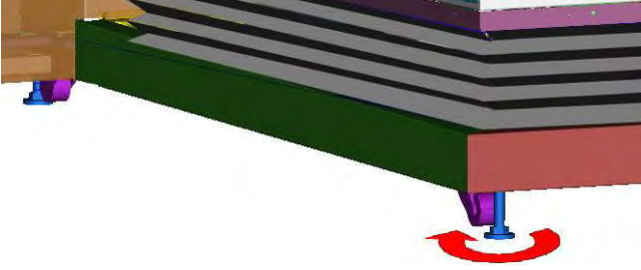
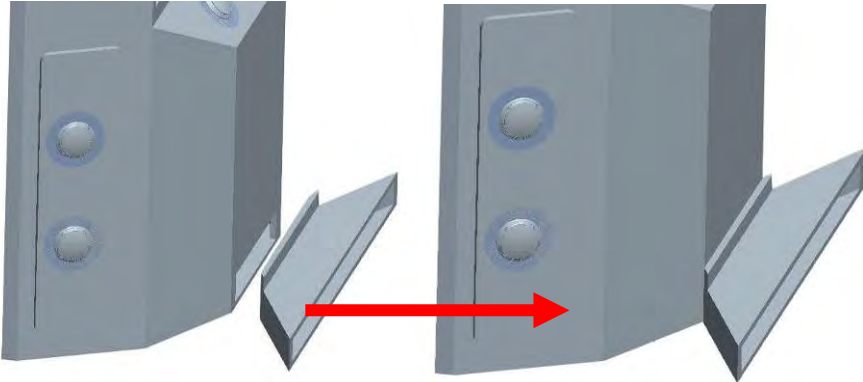
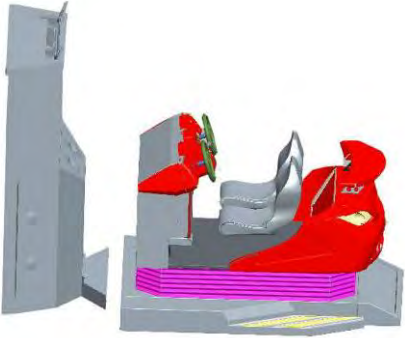
Step	Description & Diagram
1	<p>Adjust unit stands by a hex wrench to make sure STREET RACING STARS SDX2-1 motion system is placed flat on the ground and the brackets are tightly installed.</p> 
2	<p>Fix the trapezoid part to the LCD Monitor.</p> 
3	<p>Move the LCD part close to the motion base</p> 
4	<p>Connect all connectors. And then close two parts.</p>



InJoy Motion Corp.

STREET RACING STARS SDX2-1 Service Manual

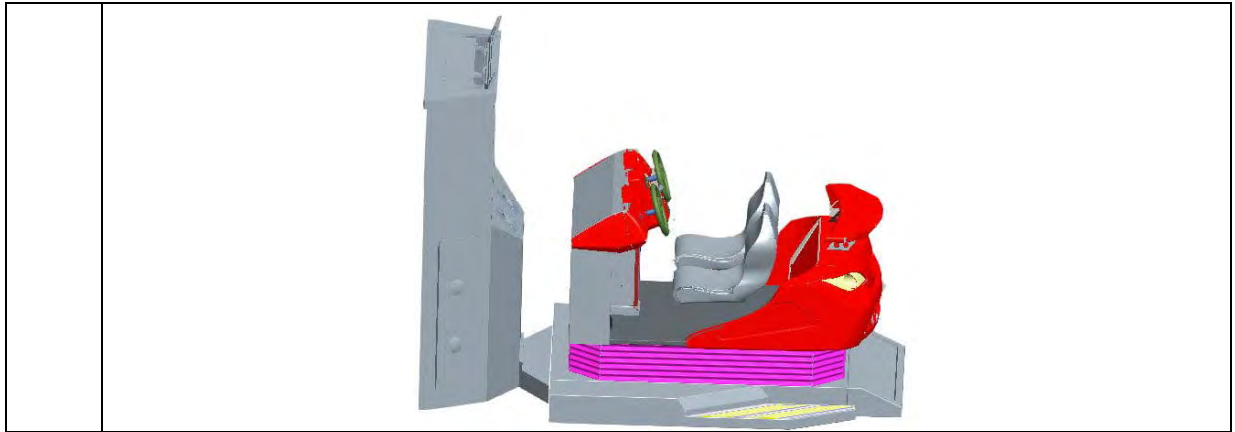

3.2.3 INSTALL SIDE STEPS

Please install the Side Step by following the steps.

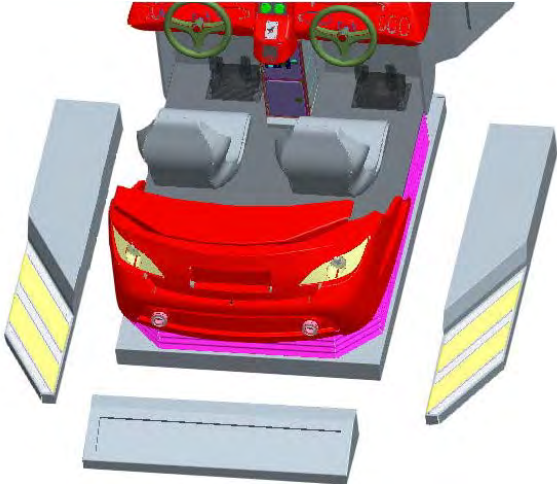
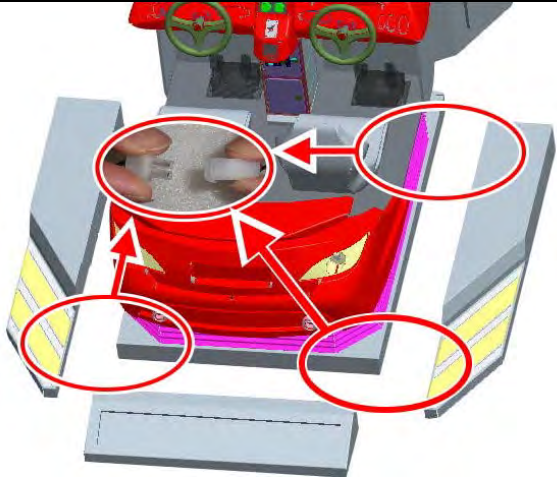
Step	Description & Diagram
1	<p data-bbox="347 831 1206 869">Put three steps near the base, and then connect the lamp connector</p> 
2	<p data-bbox="347 1417 1174 1456">Connect the lamp power connector on the right side of the base.</p> 
3	<p data-bbox="347 1944 1177 1982">Push three steps close to the base, and then fix it by L type plate</p>



InJoy Motion Corp.

STREET RACING STARS SDX2-1 Service Manual

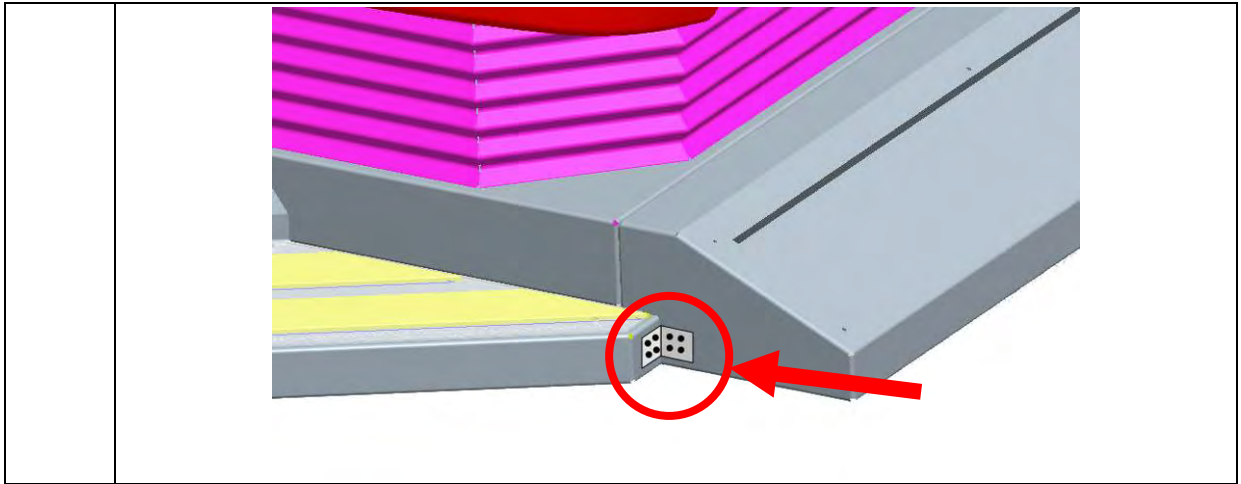



InJoy Motion Corp.

STREET RACING STARS SDX2-1 Service Manual

3.2.4 INSTALL HEAD LAMP

Please install the Head Lamp by following the steps.

Note: When installing the Acrylic Sheet, be caution not to damage it.

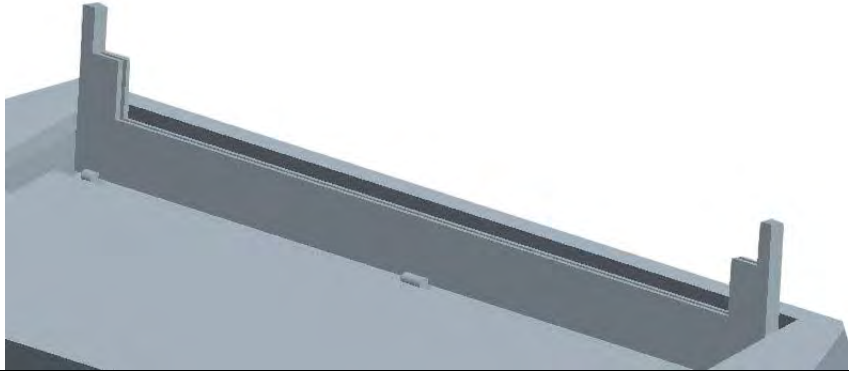
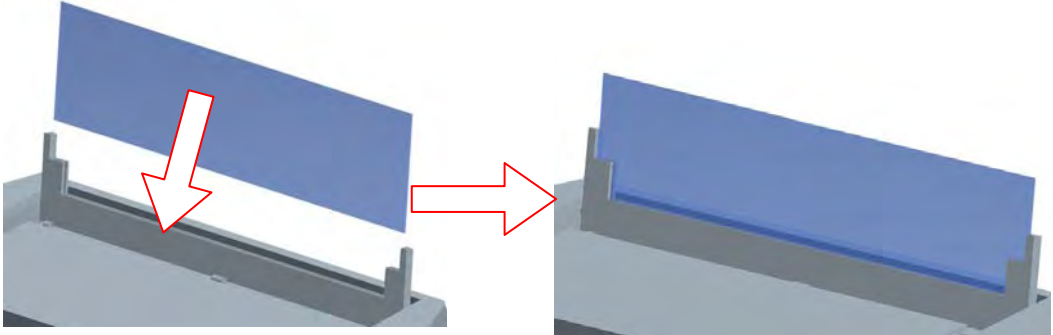
Step	Description & Diagram
1	Find the Acrylic Sheet frame on the top of the LCD screen as shown in the figures below. 
2	Plug in the Acrylic Sheet on the Light Box, and then fix it with four fixing screws. 

3.2.5 SETCOIN ACCEPTOR



Please set up the coin acceptor by following the steps below.

Step	Description & Diagram
1	Pull up the slider of the coin acceptor

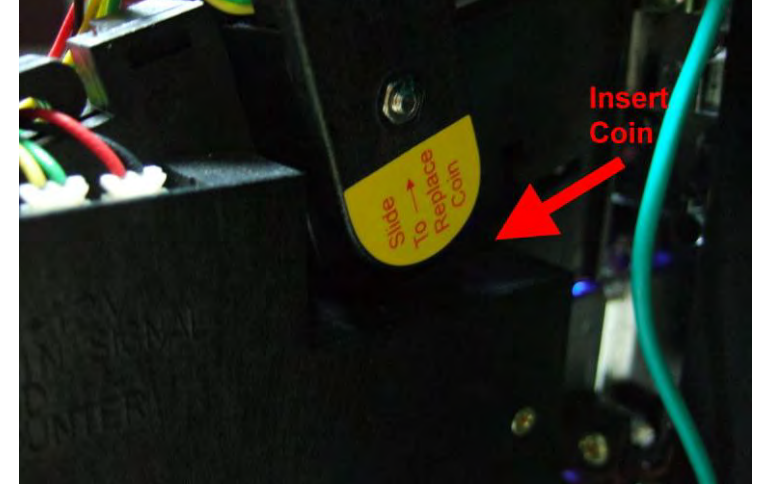

InJoy Motion Corp.

STREET RACING STARS SDX2-1 Service Manual

	
2	Insert the coin into the coin acceptor.
	
3	Push down the slider to fix the coin acceptor.
	
4	The coin acceptor is installed then, and can take the coin you want.



InJoy Motion Corp.

STREET RACING STARS SDX2-1 Service Manual

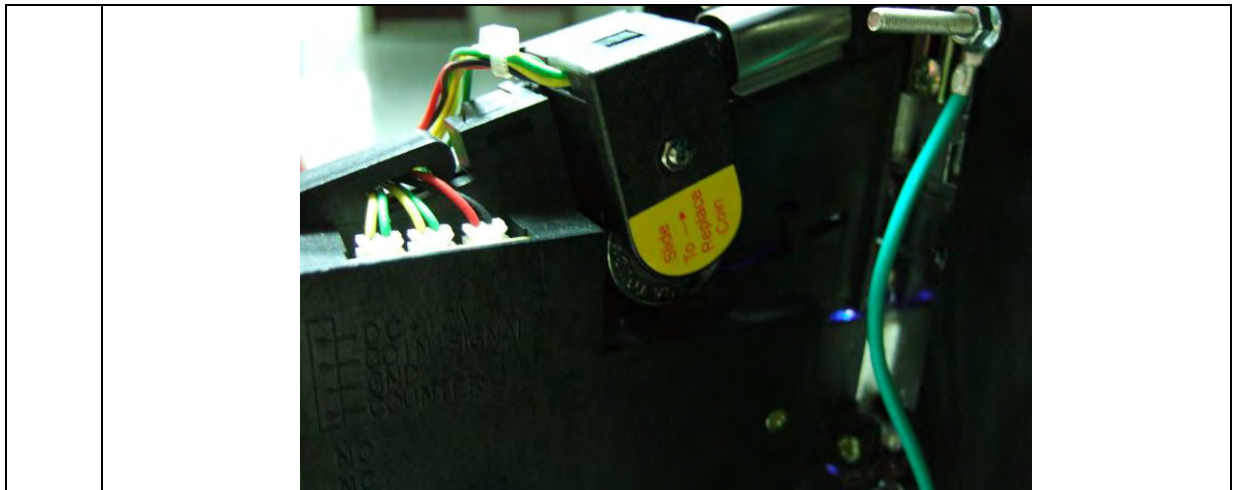

3.2.6 INSTALL DEBIT CARD

If STREET RACING STARS SDX2-1 needs to install a debit card or other device, Figure 4 below illustrates the connection of the debit card reader.

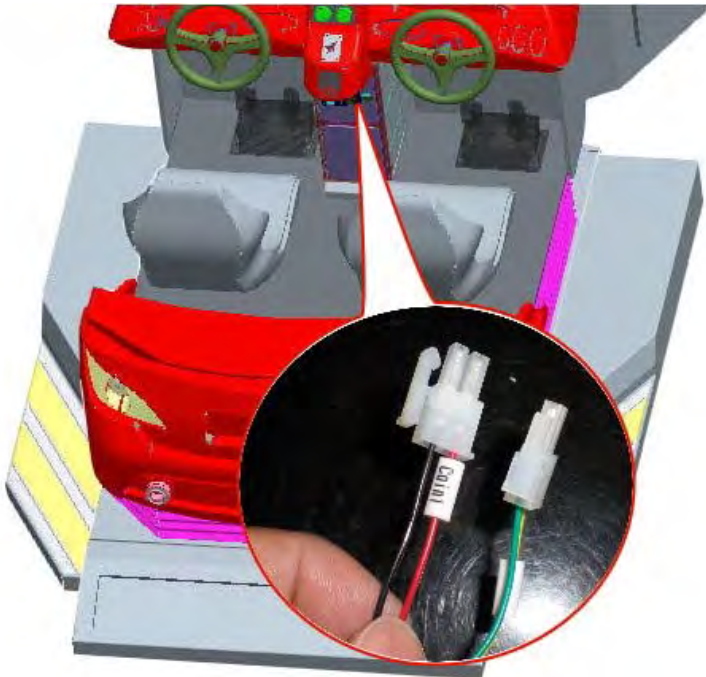
Steps	Description & Diagram
1	Find the connector "Coin 1" 
2	Please install the signal connection as shown below.



InJoy Motion Corp.

STREET RACING STARS SDX2-1 Service Manual

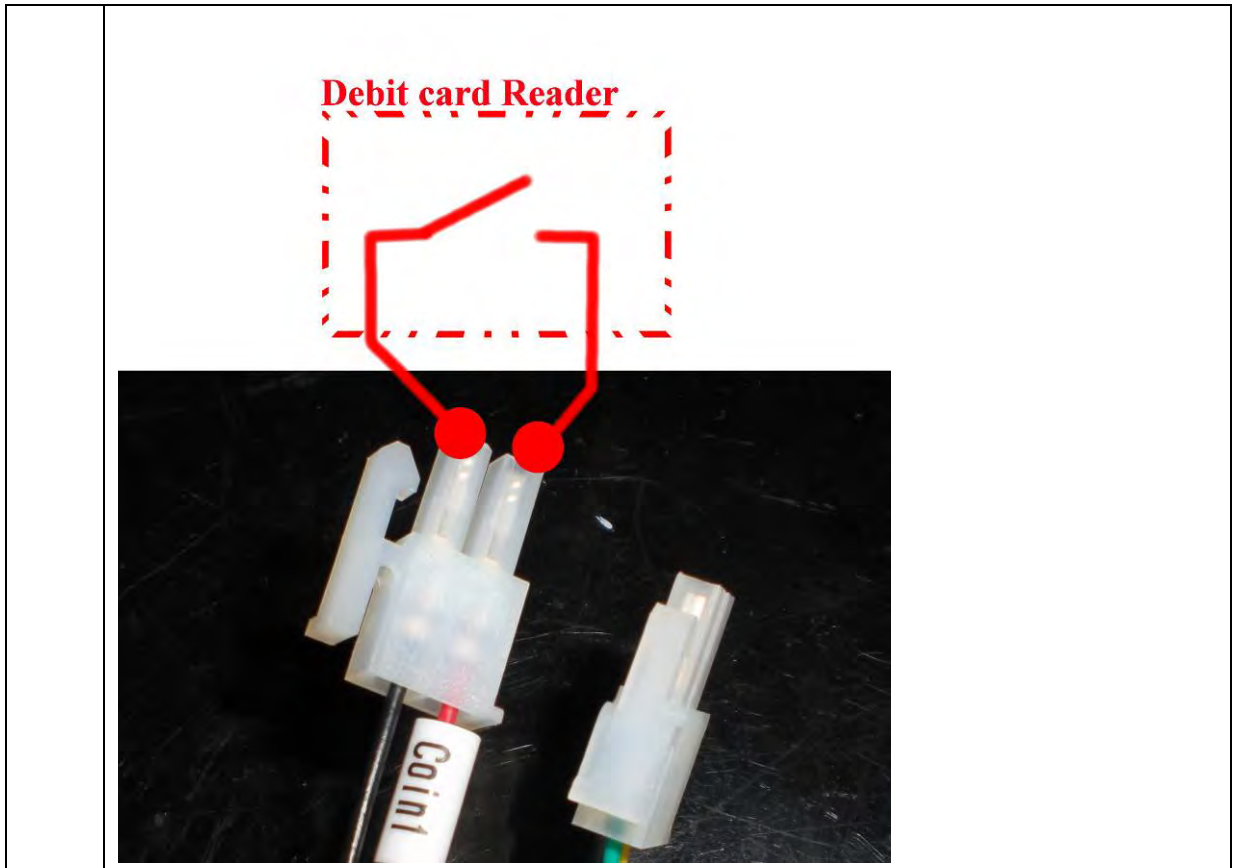

3.2.7 POWER INPUT

STREET RACING STARS SDX2-1 has a single power cord. The motion base requires one dedicated (25-Amp) circuit for (1 Φ 210~230VAC) power source.

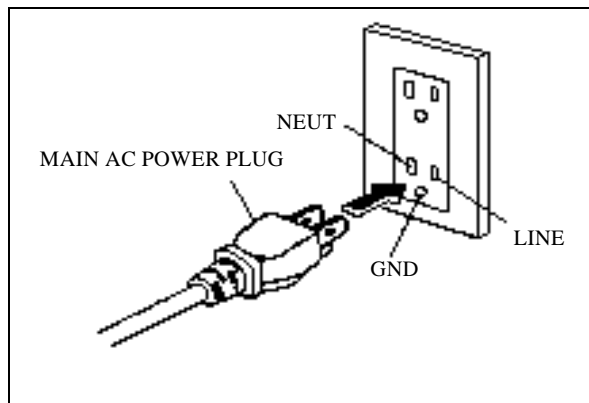

Note: 1. The diameter of the AC power cord must be larger than 2.0 mm.

2. No other appliance or game should share this power source on this circuit; otherwise, *STREET RACING STARS SDX2-1* will break down.



InJoy Motion Corp.

STREET RACING STARS SDX2-1 Service Manual

4. GAME INTRODUCTION AND SETTING

4.1 GAME SETTING (OPERATOR MENU)

To access the OPERATOR MENU, after the Power is switched ON and the screen shows “insert coin”, find the OPERATOR SWITCH located inside the coin box door and move it to “ON” position (Figure 4-1), and continue in the OPERATOR MENU (Figure 4-2).

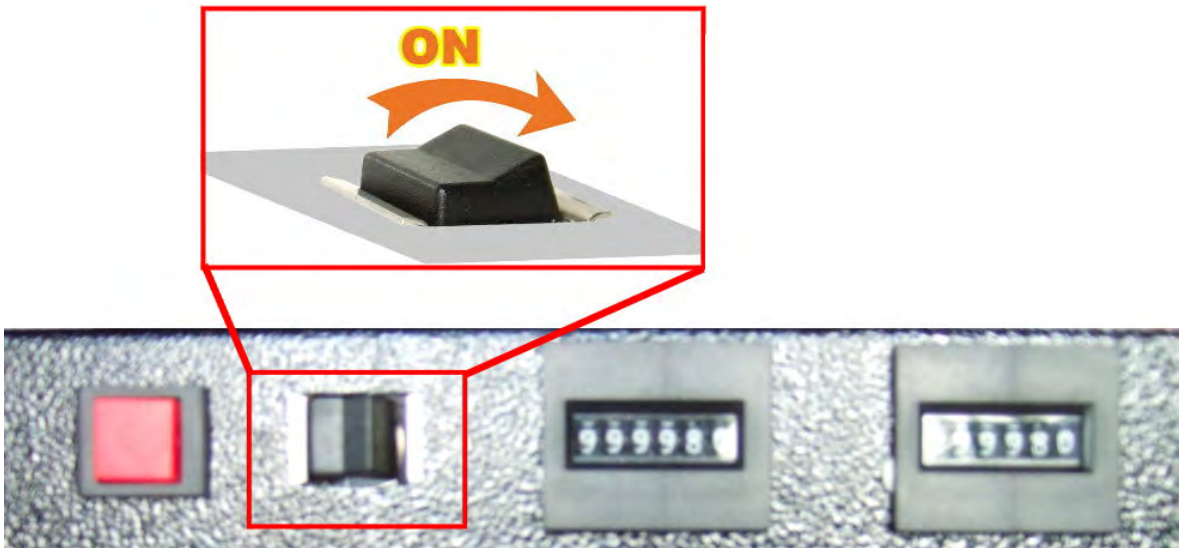

Figure 4-1 Operator Switch

From the OPERATOR MENU, you have direct access to game and operator settings. From sub-menus (listed below), you have access to general game control settings. The definitions of the Operator Menu and its sub-menu are detailed as below:



Figure 4-2 Operator Menu



InJoy Motion Corp.

STREET RACING STARS SDX2-1 Service Manual

4.1.1 COIN OPTIONS

The “***Coin Options***” sub-menu allows you to set all coin options on your ***InJoy- STREET RACING STARS SDX2-1*** (Figure 4-3).

1. “***Coins per Play***” allows you to set how many coins it will take for a player to start a game. The factory default setting value is 4 coins per play.
2. “***Coins per Continue***” allows you to charge a different price for continue-play from the first game play. The factory default setting value is 4 coins per play.
3. “***Currency Type***” is not to select the currency of a country, but allows selection of the forms of currency i.e. coins or bills you wish your ***InJoy- STREET RACING STARS SDX2-1*** accepts. The factory default setting is Coin (combined into one setting) and another setting is the Bill Acceptor or Debit Cards. The coin acceptor is an industrial standard product.
4. “***Coins per Pulse (Coin Acceptor 1)*** (Figure 4-4)” allows you to adapt different currency acceptors that are pulse specific to your ***InJoy- STREET RACING STARS SDX2-1***. The default value is 1.
5. “***Coins per Pulse (Coin Acceptor 2)*** (Figure 4-4)” allows you to adapt different currency acceptors that are pulse specific to your ***InJoy- STREET RACING STARS SDX2-1***. The default value is 1.
6. “***Winner Continue***” allows you to set up options for the winner when he/she wants to continue game: inset coin to continue or free to continue. This setting is for single player.
7. “***Winner Continue (Net)***” allows you to set up options for the winner when he/she wants to continue game: inset coin to continue or free to continue. This setting is for multiple players linked.



InJoy Motion Corp.

STREET RACING STARS SDX2-1 Service Manual

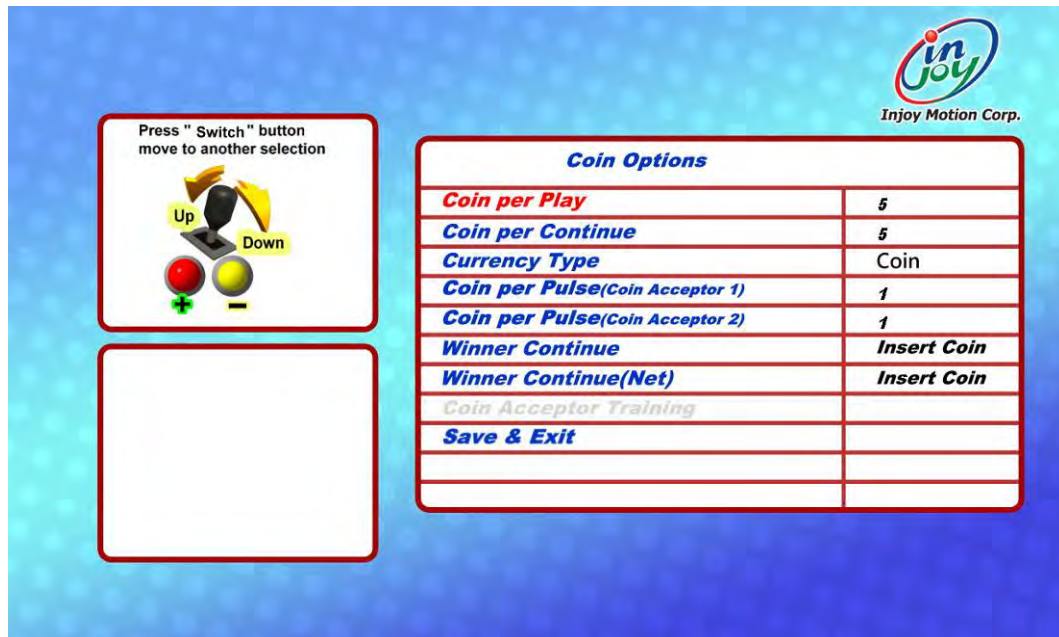

Figure 4-3 “Coin Options” sub-menu



Figure 4-4 Coin Acceptor Number

4.1.2 GAME OPTIONS

“*Game Options*” sub-menu offers settings that you can adjust for each individual software title installed on your *InJoy STREET RACING STARS SDX2-1* (Figure 4-5).

1. “*Continue Timer Length*” adjusts the amount of time for the player to decide to continue playing after their game has ended. This can be adjusted by using the “+” or “-” buttons as shown in Figure 4-5.
2. “*Game Show Operation*” enables free game play by pressing “Switch” button.
3. “*Clear High Scores*” deletes all high scores and returns to the default settings. (Figure 4-6)



InJoy Motion Corp.

STREET RACING STARS SDX2-1 Service Manual



Figure 4-5 “Game Options” sub-menu

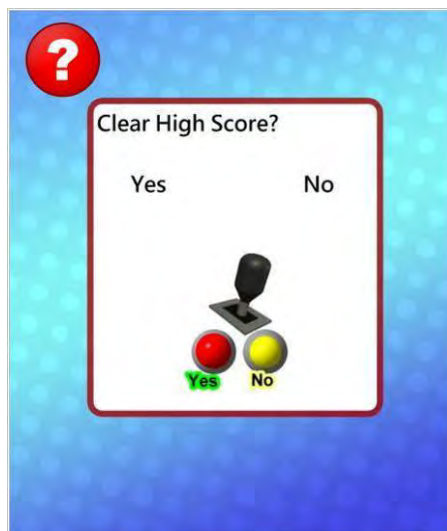

Figure 4-6 “Clear High Scores” Window

4.1.3 PEDAL SETTING

To calibrate the Throttle, follow the directions on the screen and go through these steps (Figure 4-7 ~ Figure 4-10):

1. Hold the “Calibrate” button on the Panel to calibrate the pedal and brake.
2. Release the Brake and Pedal, then press “Next” button.
3. Press the Brake and Pedal to limit and then press “Next” button.



InJoy Motion Corp.

STREET RACING STARS SDX2-1 Service Manual

4. After finishing the calibration, press “Exit” button to exit calibrate.

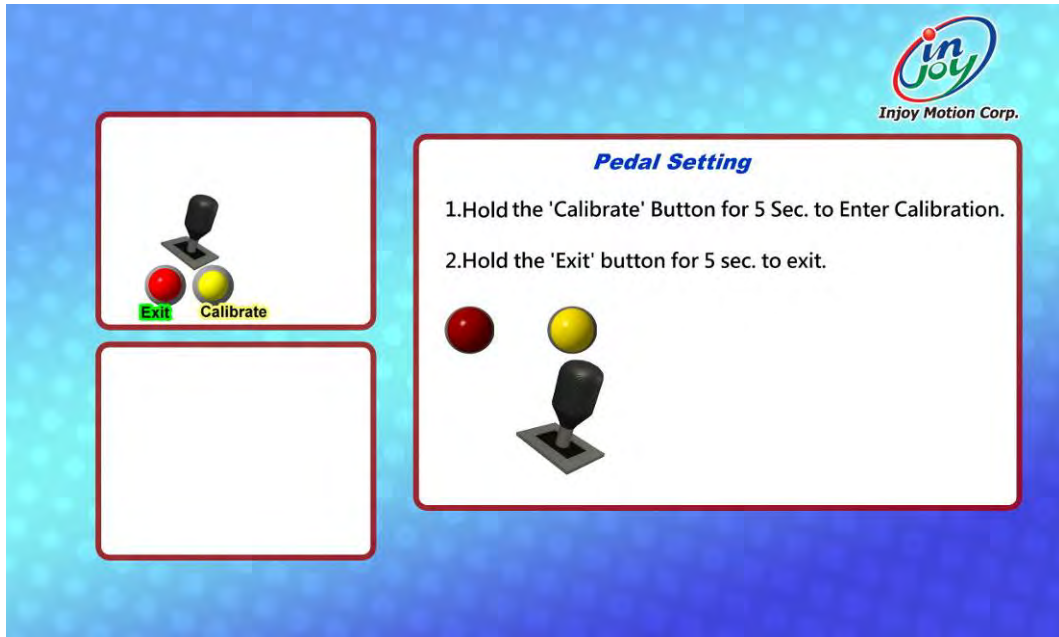

Figure 4-7 Pedal Setting

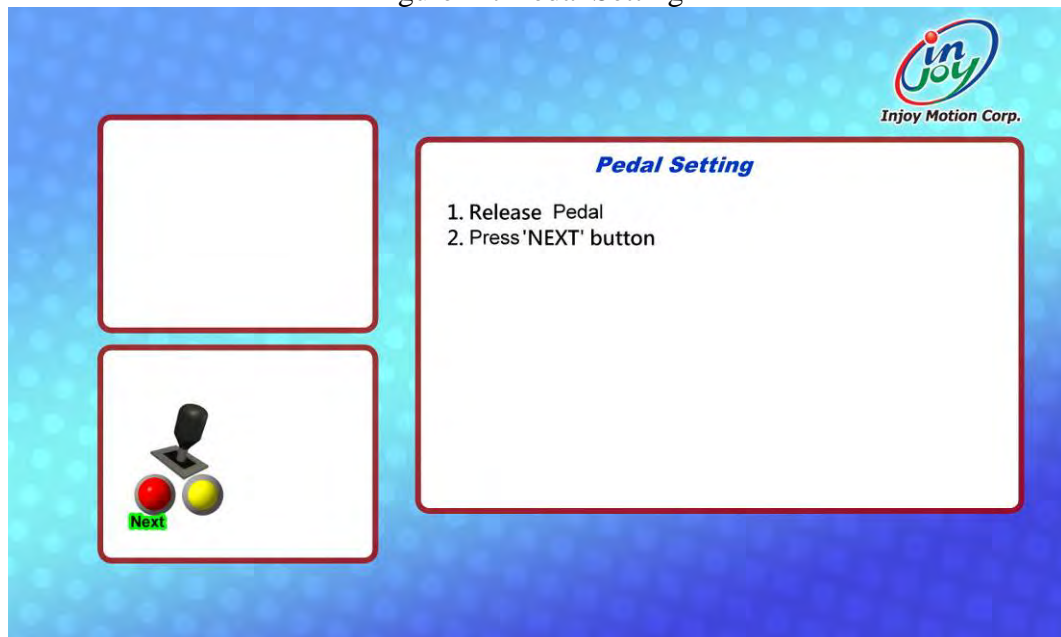

Figure 4-8 Calibrate Pedal



InJoy Motion Corp.

STREET RACING STARS SDX2-1 Service Manual

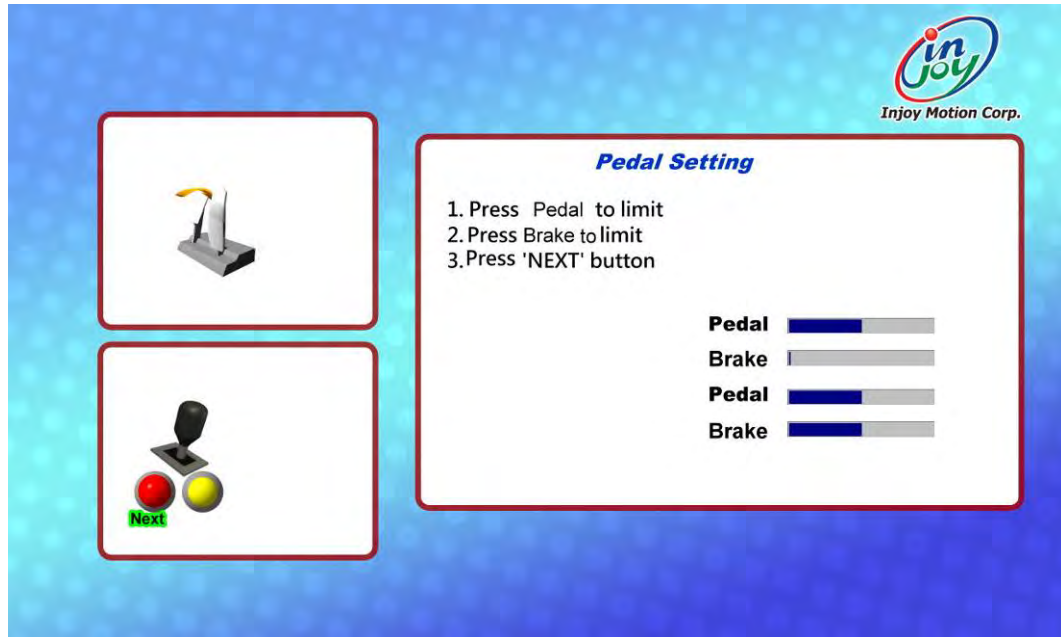

Figure 4-9 Calibrate Pedal

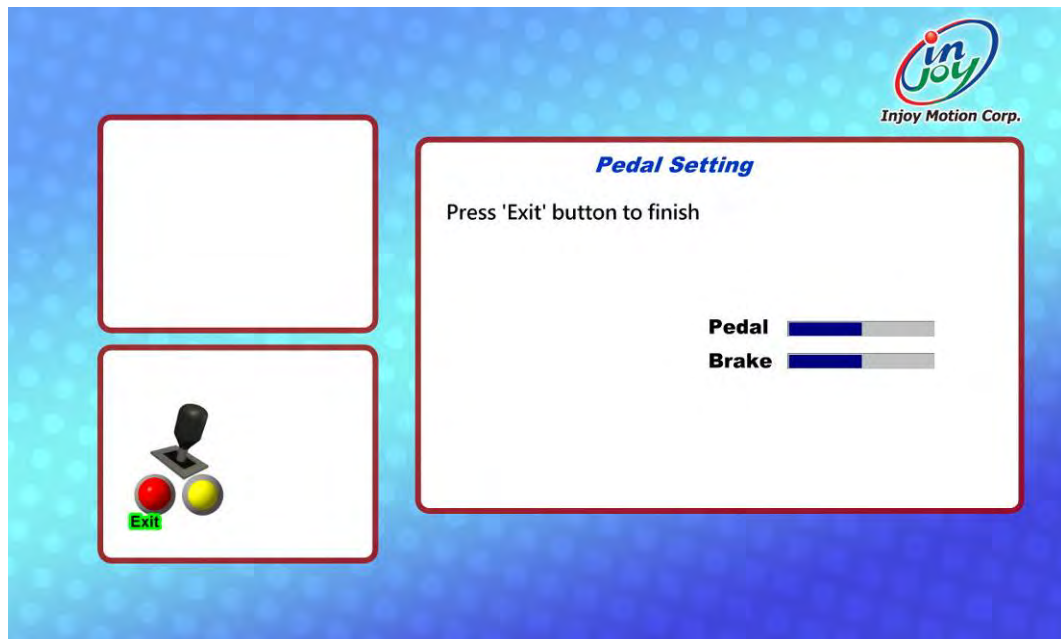

Figure 4-10 Finish calibration



InJoy Motion Corp.

STREET RACING STARS SDX2-1 Service Manual

4.1.4 LANGUAGE SETTING

Language can be adjusted by using the “+” or “-” buttons (Figure 4-11) to change game language. Currently, English and Chinese are available.

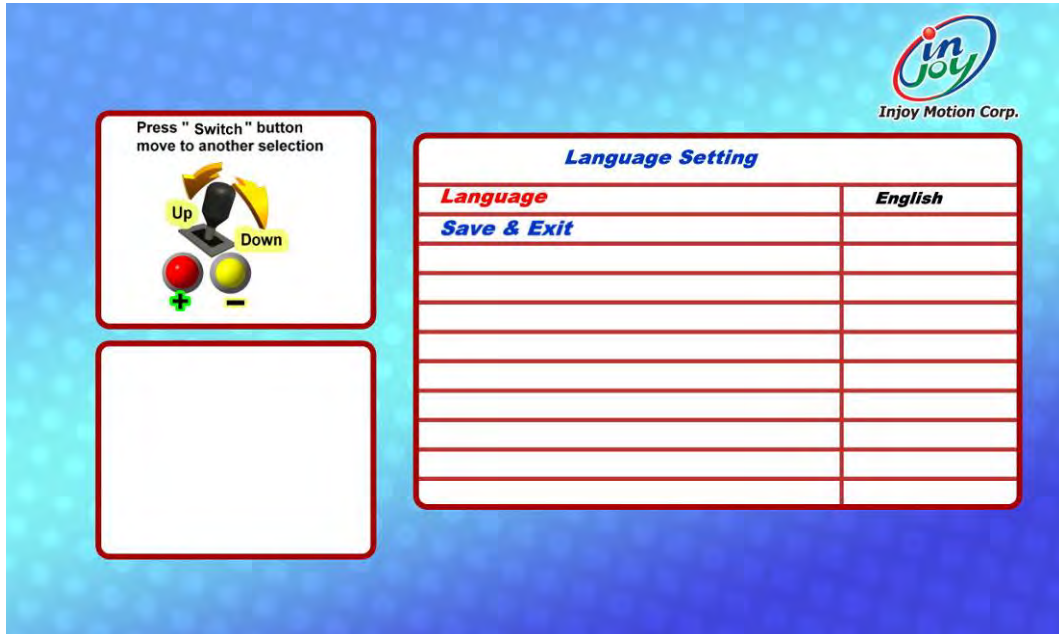

Figure 4-11 “Language Setting” sub-menu

4.1.5 SYSTEM TIME SETTING

Setting the system time can be accomplished by using the “switch” button to choose, followed by the “+” or “-” buttons (Figure 4-12) to change date or time. Time is displayed in 24 hour or military time.

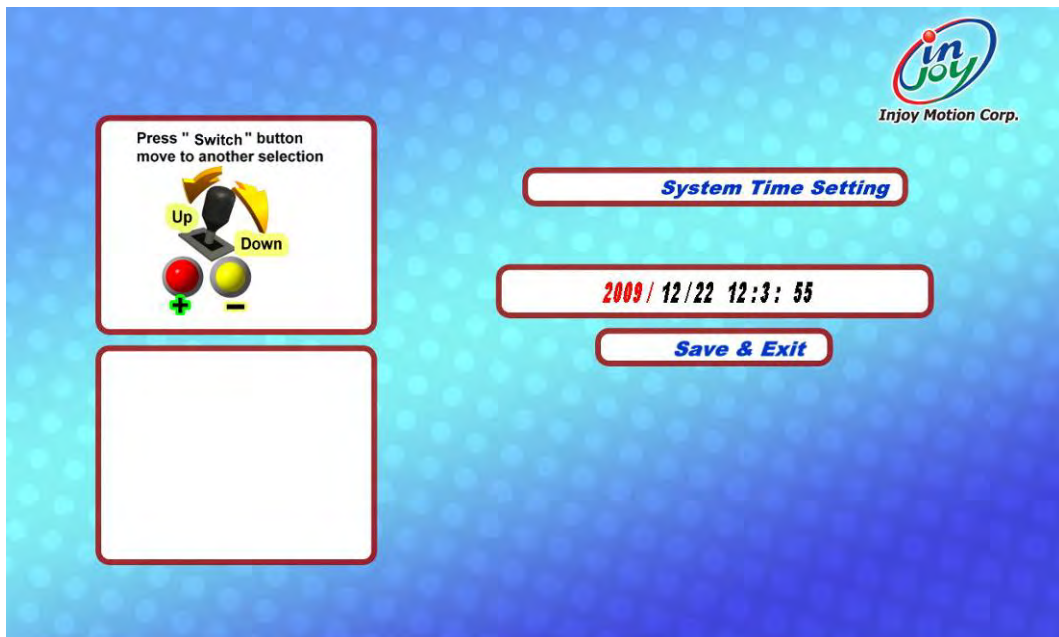

Figure 4-12 “System time Setting” sub-menu



InJoy Motion Corp.

STREET RACING STARS SDX2-1 Service Manual

4.1.8 SOFTWARE UPGRADE

Any software upgrades and new software game titles will be downloaded to your ***InJoy STREET RACING STARS SDX2-1*** through the use of USB Flash Disk provided by ***InJoy*** or your distributor. Please follow the procedures below to upgrade software:

1. Open the maintenance door (Figure 4-15).

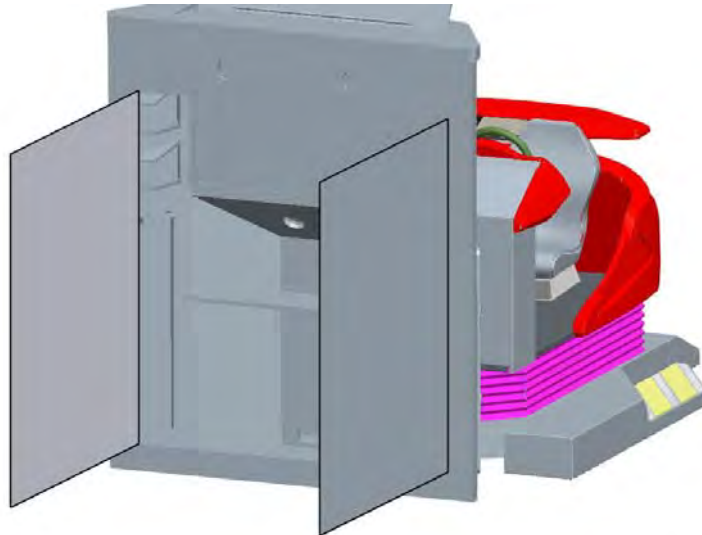

Figure 4-15 Open maintenance door

2. Locate the system's PC (Industrial PC): Referring to Figure 4-16, open the maintenance door located at the back of the LCD. You can see the PC is installed at the left corner.

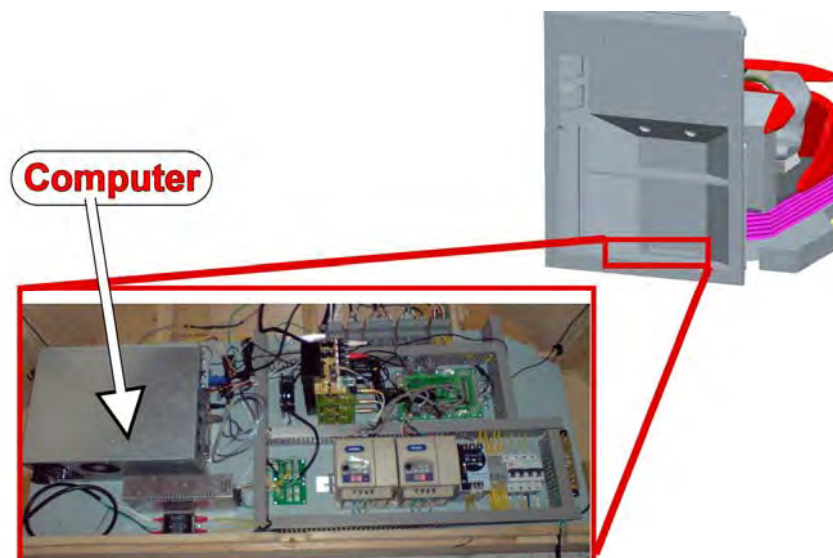

Figure 4-16 Locate the system's PC (Computer)

3. Plug in the USB Flash Disk. (Only use the USB Flash Disk provided by ***InJoy*** or your distributor to upgrade/download the software. The USB Flash Disk from unauthorized sources might seriously damage the system.)



InJoy Motion Corp.

STREET RACING STARS SDX2-1 Service Manual

4. On Operator Menu, press the “*select*” button on the panel (please refer to Figure 4-2) to select “*Software Upgrade*” sub-menu.
5. Press the “*upgrade*” button on the panel (Figure 4-17), and your software system will begin to upgrade/download the software automatically (Figure 4-18).

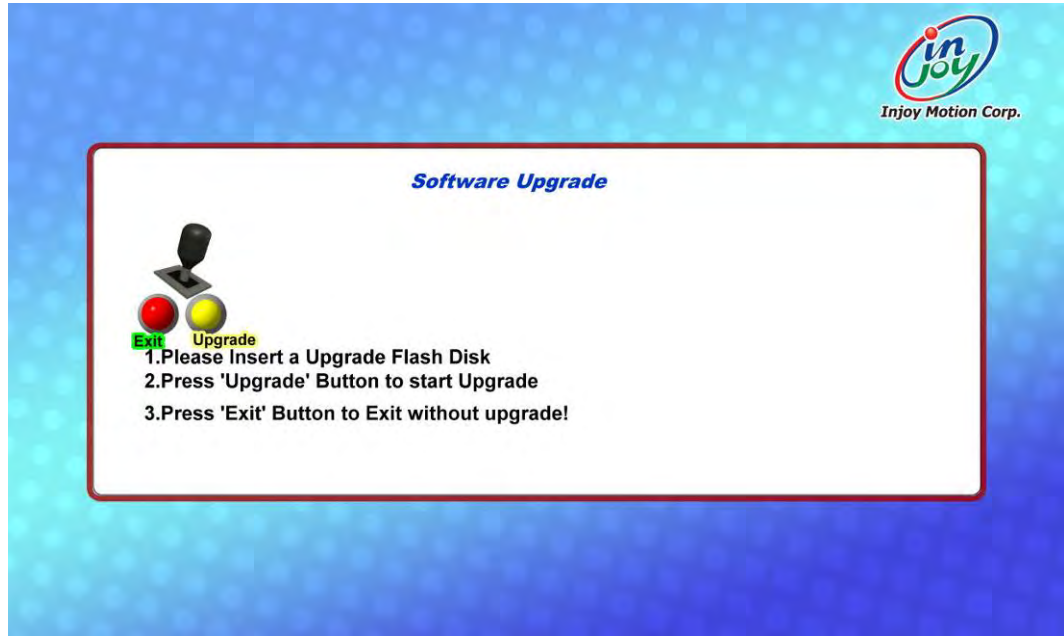

Figure 4-17 “*Software Upgrade*” sub-menu

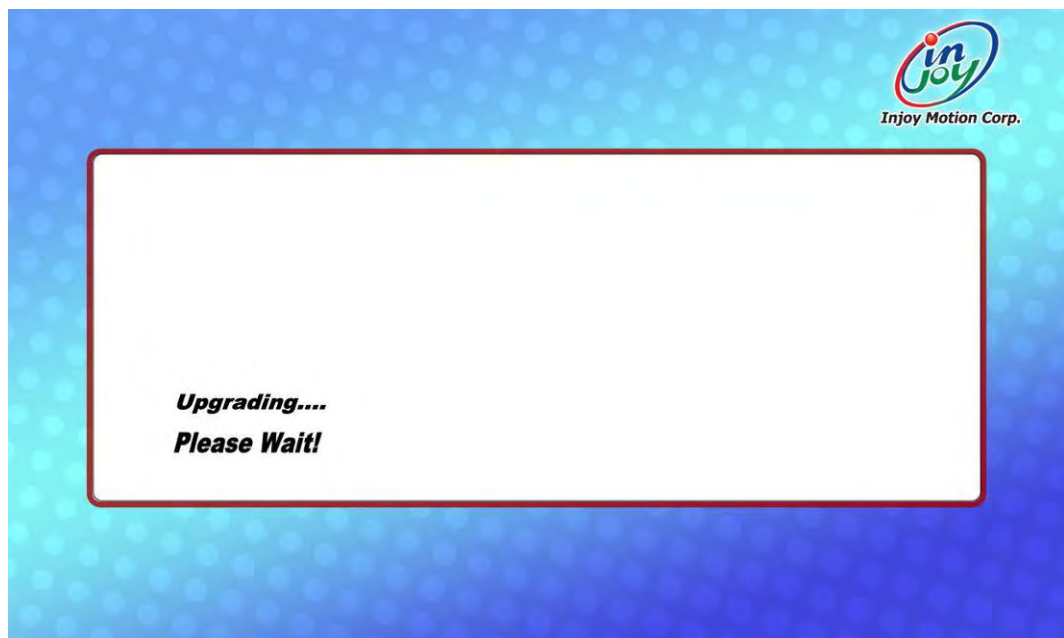

Figure 4-18 “*Software Upgrading*” Window

Progress will be indicated on screen and you will be notified when download is complete (Figure 4-19). (If you didn't plug the USB Flash Disk onto the PC, it will display an “*Upgrade fails*” window (Figure 4-20).



InJoy Motion Corp.

STREET RACING STARS SDX2-1 Service Manual

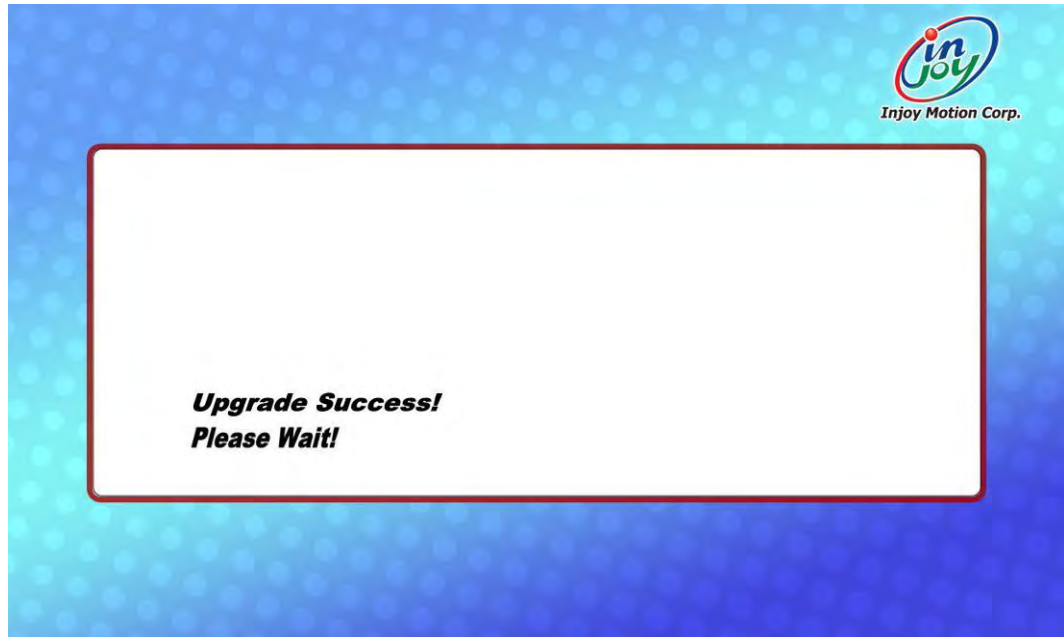

Figure 4-19 “*Upgrade Success*” Window

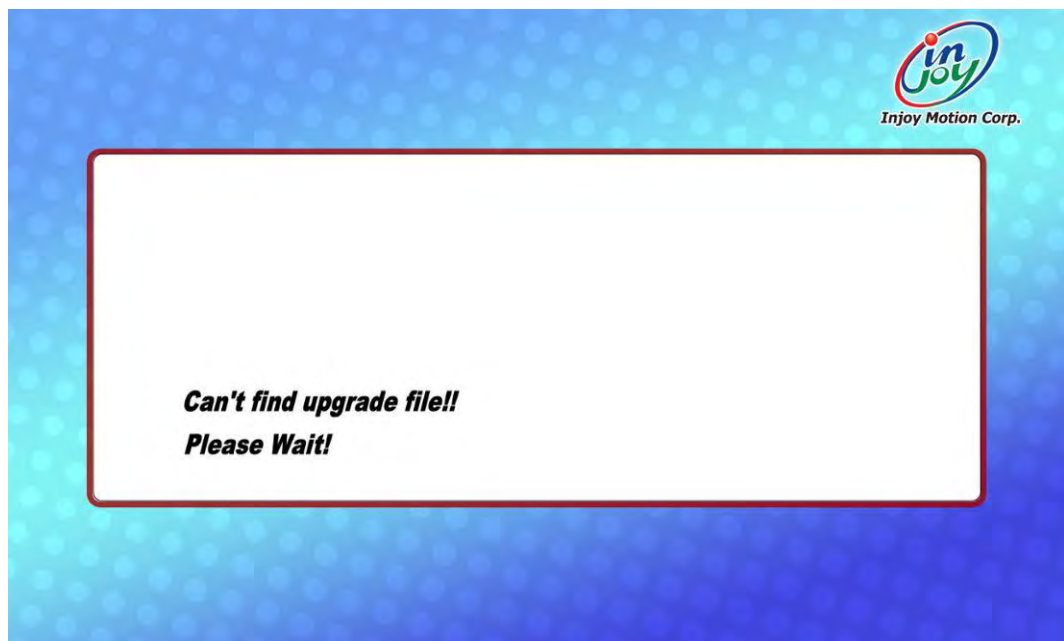

Figure 4-20 Upgrade fails

6. If you wish to cancel upgrade process, press the” Exit” button (Figure 4-17) to exit “*Software Upgrade*” sub-menu.

If the screen shows “Can’t find upgrade file” when you have upgraded the file, please pull out the motion card USB cable and the USB disk. Then plug in the USB disk and try software upgrade again.



InJoy Motion Corp.

STREET RACING STARS SDX2-1 Service Manual

4.1.9 STATISTIC

The information related to playing game is given (Figure 4-21) as follows:

1. “Coin Count” shows the amount of coins inserted.
2. “Total Play” shows the number of times the game has been played (Total Play = Starts + Continues).
4. “Starts” shows the number of time the game has started.
5. “Continues” shows the number of time the game has been continued.
6. “Clear Statistic” clears information in “Statistic” (all value is zero after clearing)

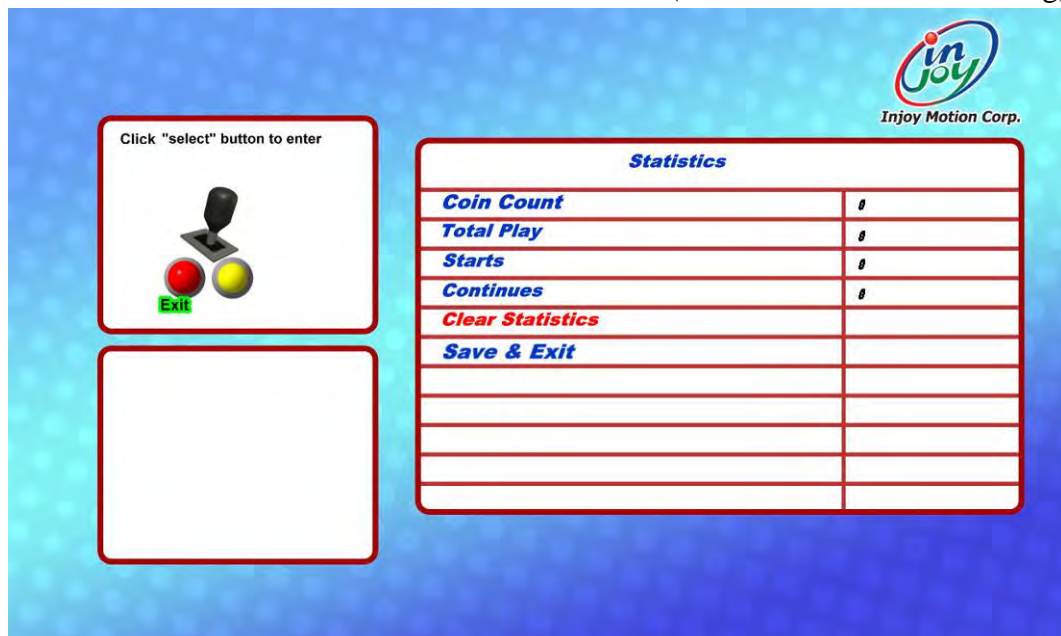

Figure 4-21 “Statistic” sub-menu



InJoy Motion Corp.

STREET RACING STARS SDX2-1 Service Manual

4.1.10 SAVE & EXIT

After the setup is completed, the system needs to exit. Please select “Save & Exit”, and then the screen will prompt “Yes” or “NO”. If you press “YES” (Figure 4-22), the system will show” Shutdown.....!! Please turn the Operator switch to the OFF position.” (Figure 4-23)

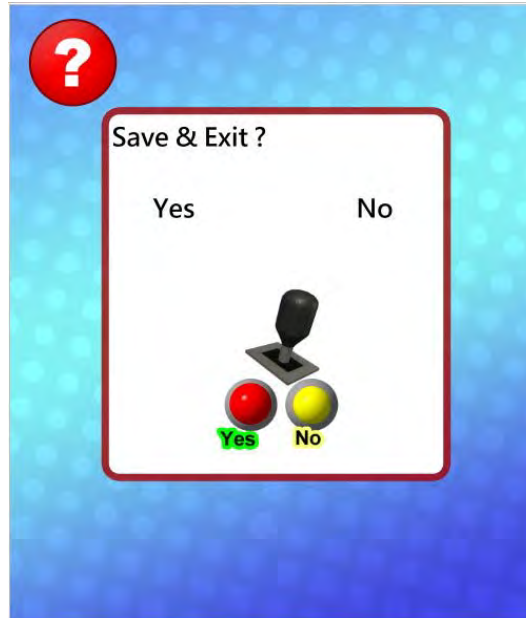

Figure 4-22 Save & Exit window

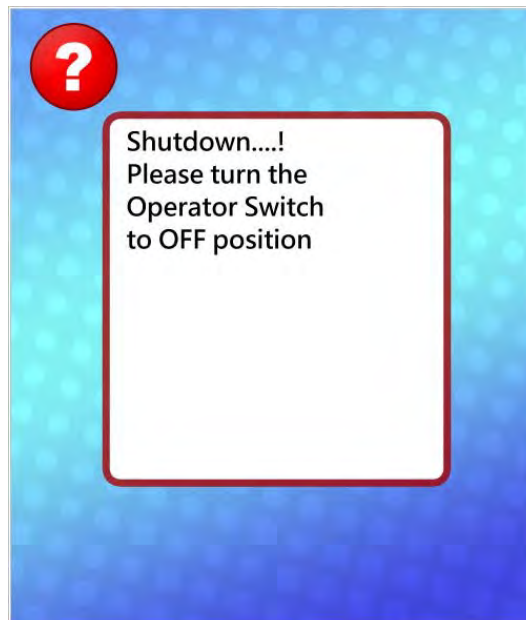

Figure 4-23 Shutdown prompt



Injoy Motion Corp.

STREET RACING STARS SDX2-1 Service Manual

4.2 GAME INTRODUCTION

4.2.1 GAME CONTROL

The player uses the steering wheel, throttle and buttons (Figure 4-24) to control the cars. Click the yellow button to start the game. While playing, click the yellow button to turbo, and click the red button to change View on the Screen.

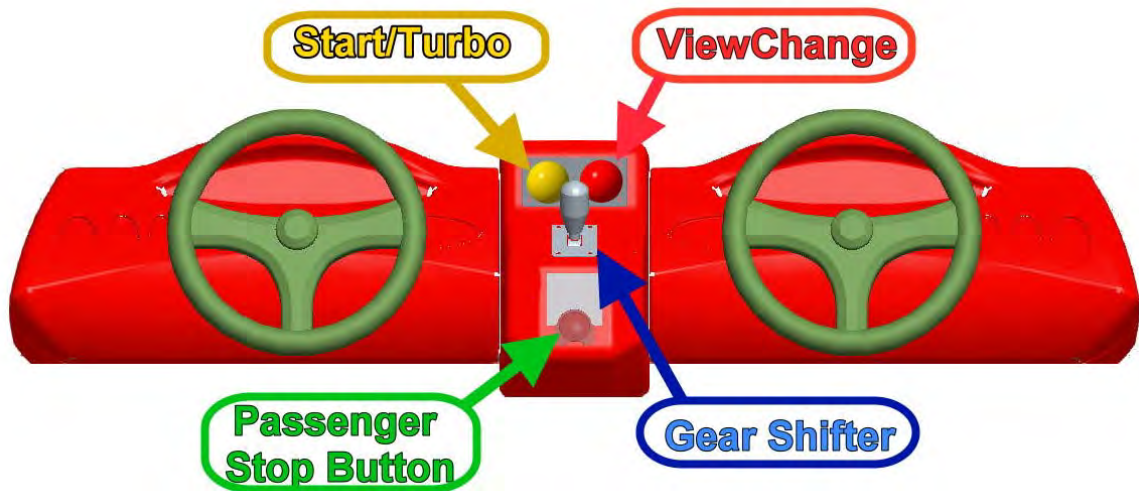

Figure 4-24 Game control interfaces



InJoy Motion Corp.

STREET RACING STARS SDX2-1 Service Manual

5. MAINTENANCE

5.1 CHASSIS ELECTRONIC COMPONENTS

Figure 5-1 ~ Figure 5-3 are the electronic components of the chassis.

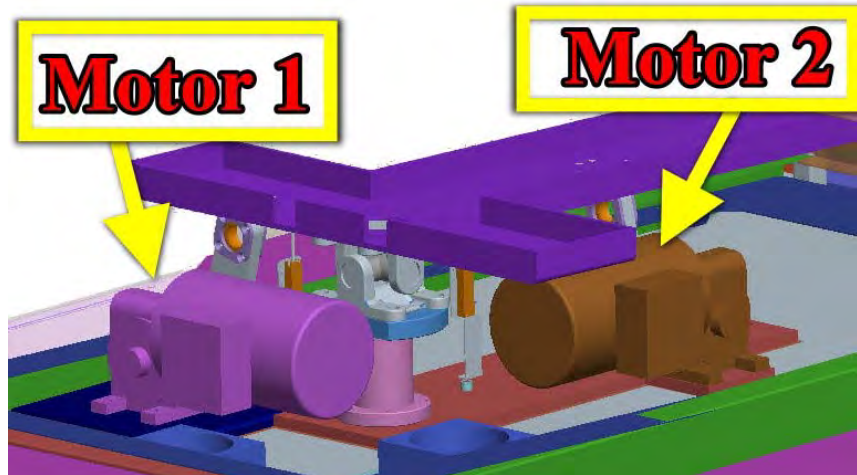

Figure 5-1 Chassis Electronic Components-1

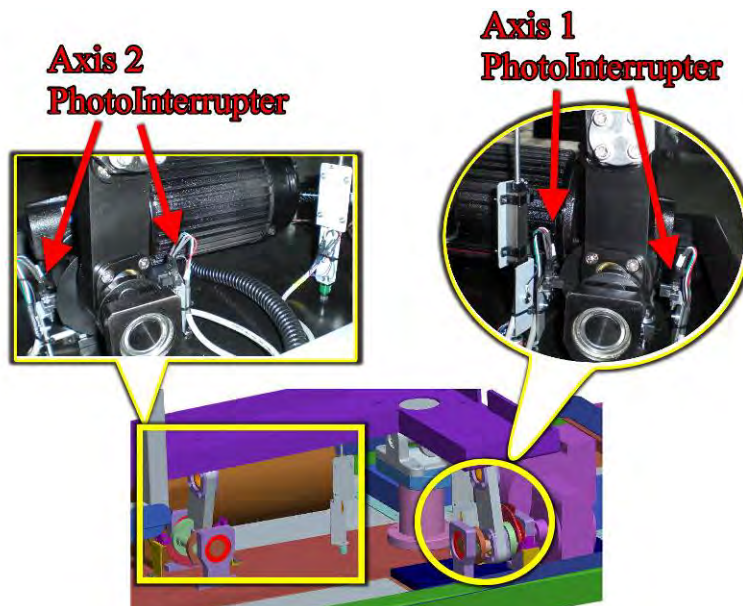

Figure 5-2 Chassis Electronic Components-2



InJoy Motion Corp.

STREET RACING STARS SDX2-1 Service Manual



Figure 5-3 Chassis Electronic Components-3

5.2 CABINET ELECTRONIC COMPONENTS

Figure 5-4 shows the Cabinet electronic components.

Figure 5-5 shows the LCD screen electronic components.

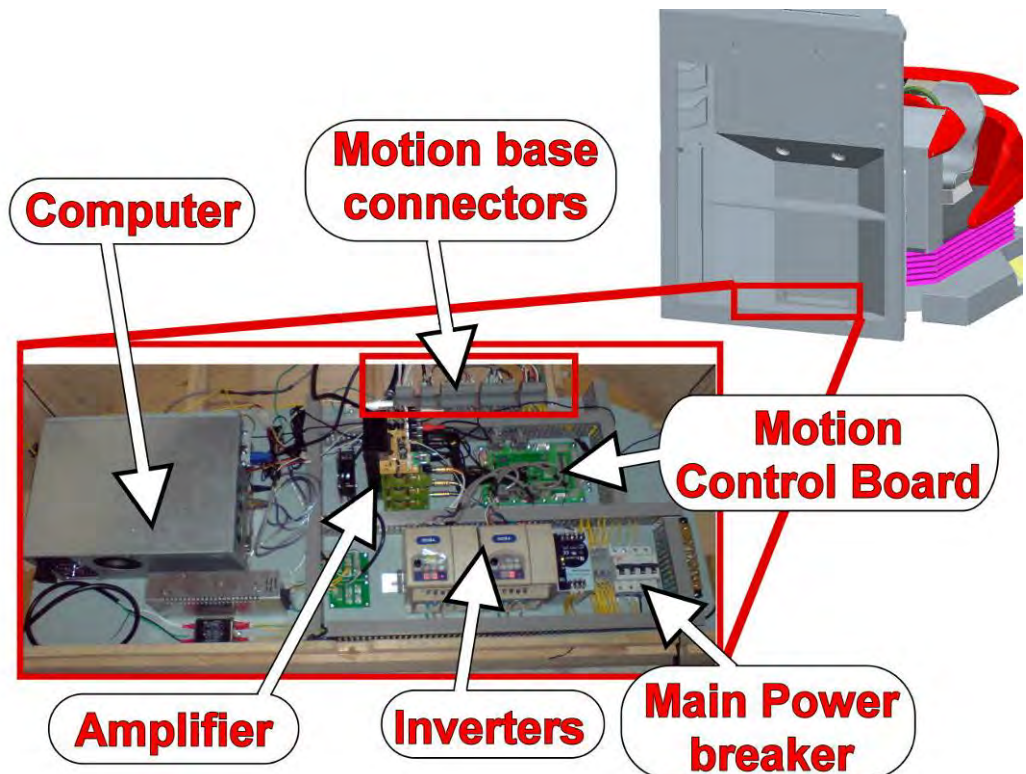

Figure 5-4 Cabinet electronic components



InJoy Motion Corp.

STREET RACING STARS SDX2-1 Service Manual

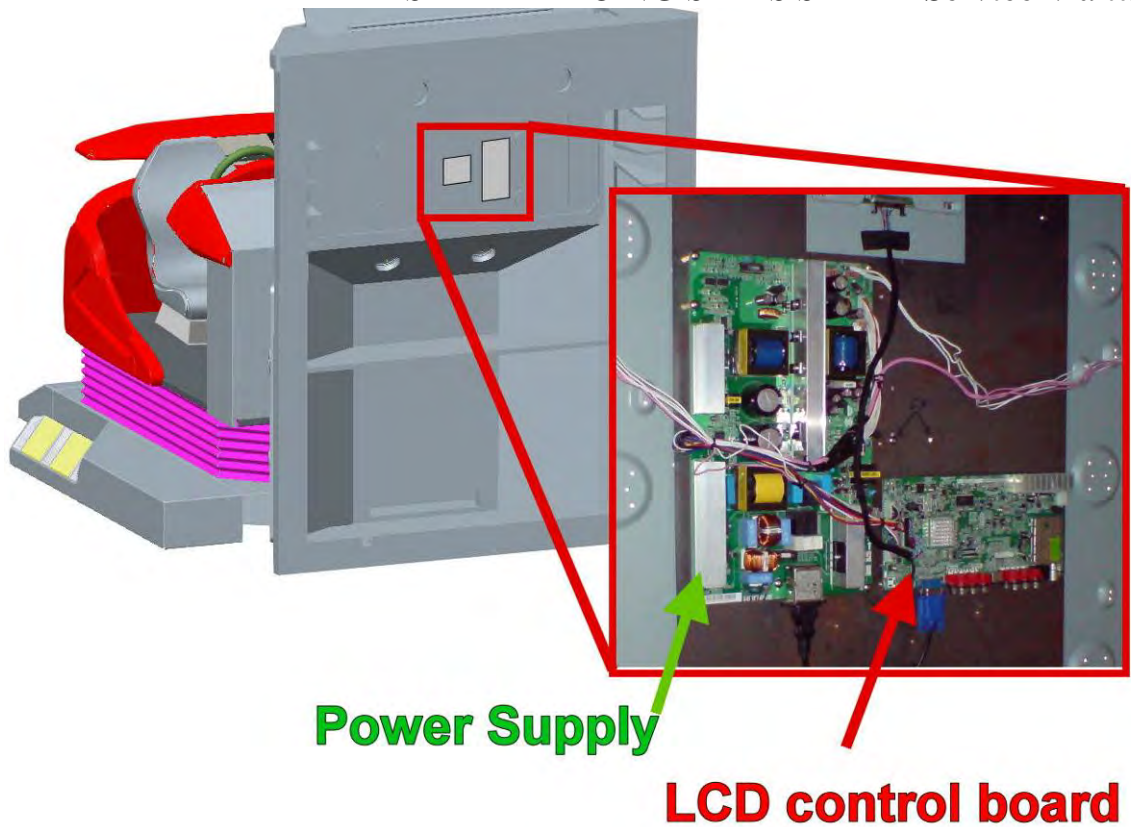

Figure 5-5 LCD electronic devices

5.3 COCKPIT ELECTRONIC COMPONENTS

Figure 5-6 ~ Figure 5-7 show the cockpit electronic components.

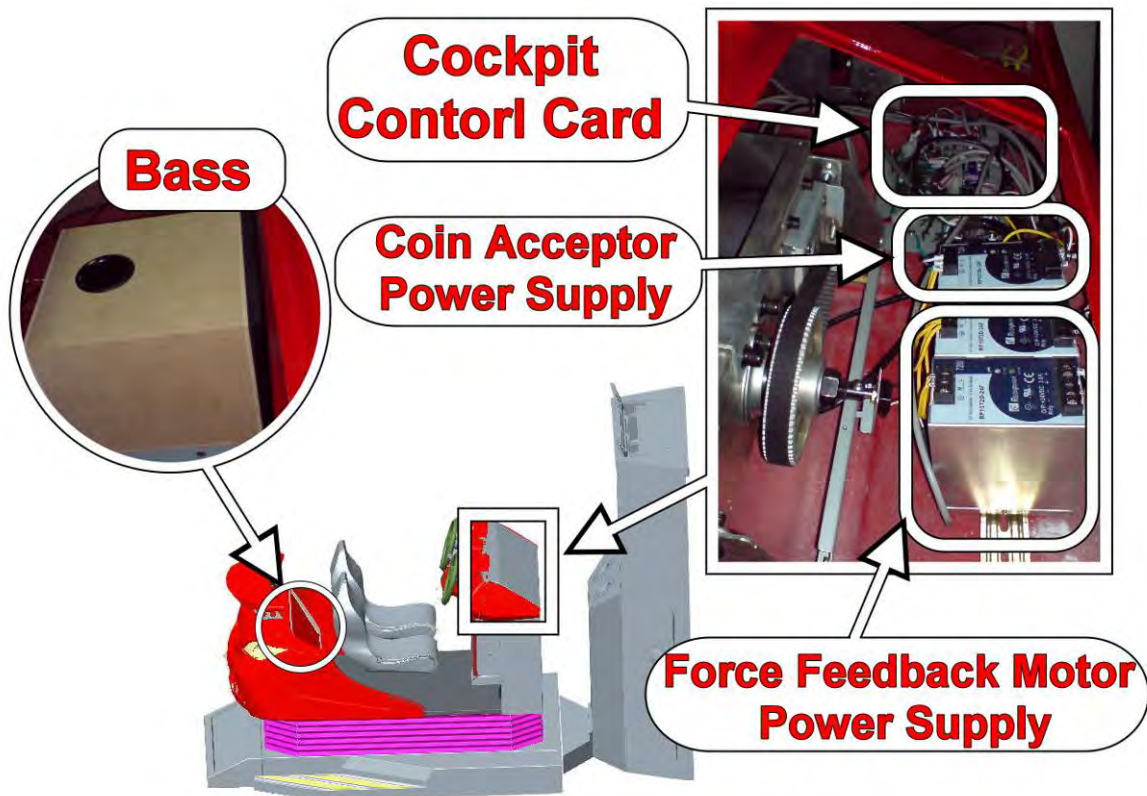

Figure 5-6 Cockpit electronic components-1



InJoy Motion Corp.

STREET RACING STARS SDX2-1 Service Manual

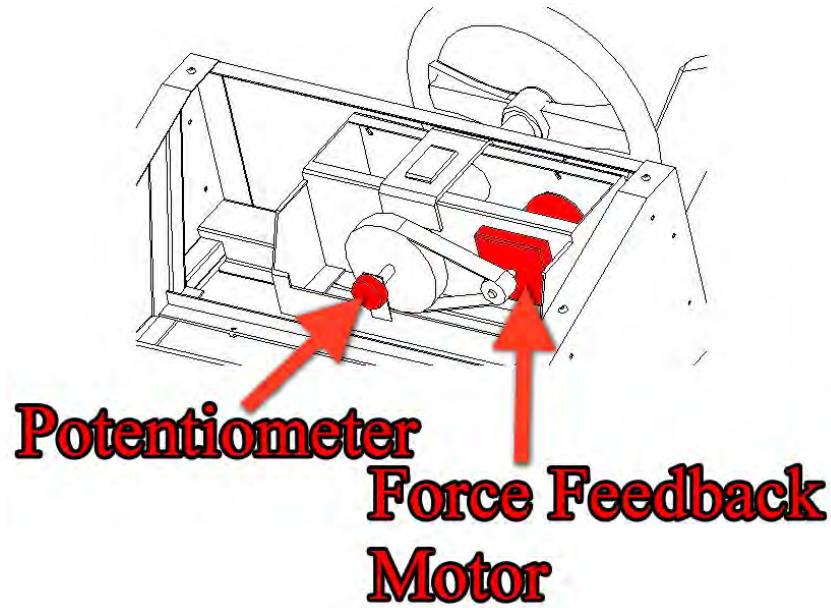

Figure 5-7 Cockpit electronic components-2

5.4 MAINTENANCE

Figure 5-8 shows the chassis of the STREET RACING STARS SDX2-1, also known as the “Rotation Point” which needs to be lubricated every 6 months.

“Rotation Point” is the rotation axis. When the motion starts up, the rotation axis will produce friction, and need lubrication semi-annually.

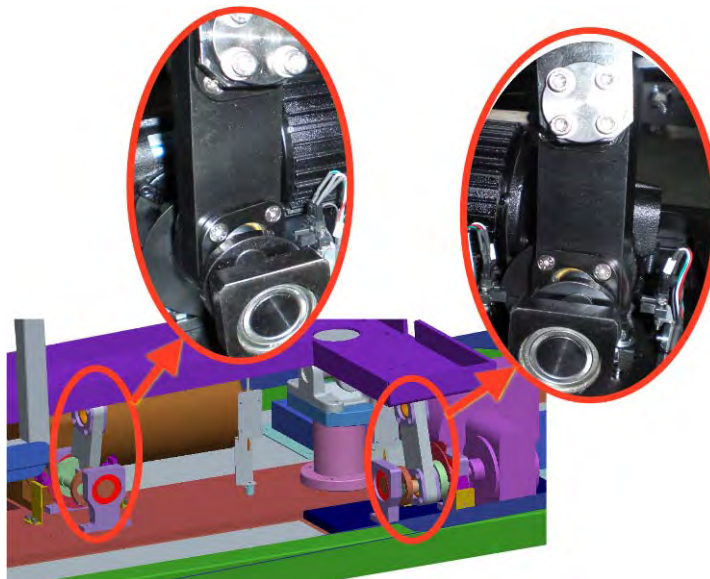

Figure 5-8 Rotation point

Figure 5-9 shows the transmission belt that transmits the force feedback from the motor to the steering wheel. The transmission belt needs to be checked every 6 months. If the force feedback decreases, please check the belt.

When the game starts, the steering wheel will simulate the force feedback of the steering wheel of a real car.



Injoy Motion Corp.

STREET RACING STARS SDX2-1 Service Manual

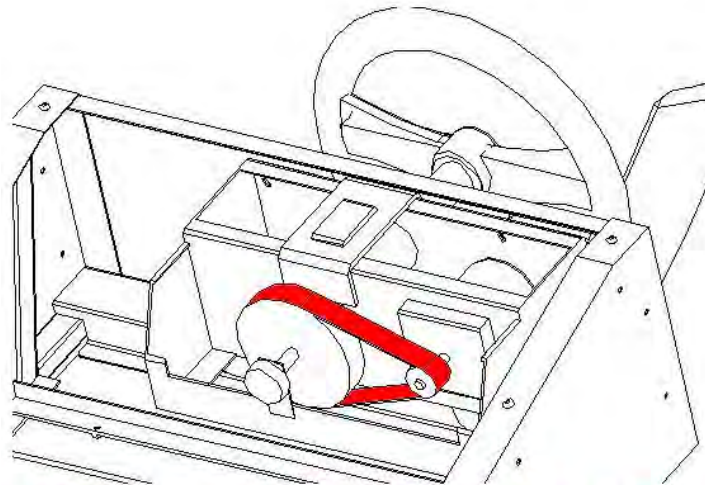

Transmission Belt

Figure 5-9 Transmission belts



InJoy Motion Corp.

STREET RACING STARS SDX2-1 Service Manual

6. TROUBLE SHOOTING

After it turns on, Street Racing Stars SDX2-1 will boot up as the following steps.

Step	Symptom
1	The computer system boots up, and the steering wheel rotates to left limit and then to right limit.
2	After 40 seconds, the base starts “Homing (base starts rotating and then returns to the center position)”.
3	When Homing is done, the screen will show “Loading...”
4	After Loading is finished, the screen will display animation video.

1. Boot-up fails

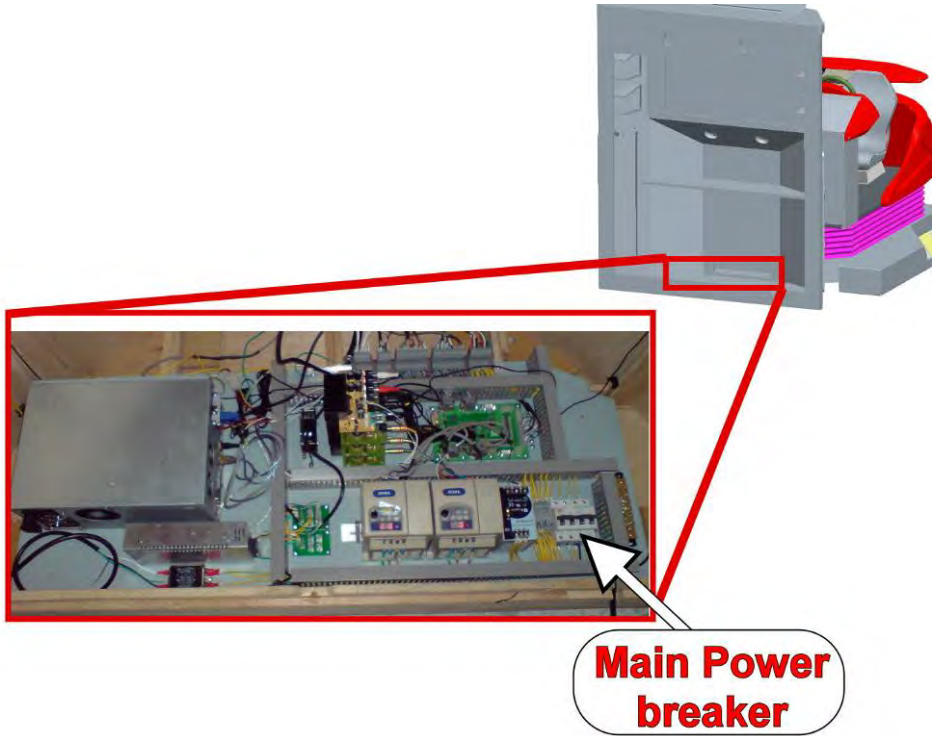
Step	Trouble Shooting Guide
1	Please check if the input power is 220V AC.
2	<p>Please open the maintenance door, and check the power breaker.</p> <p>If the breaker is OFF, please turn it to ON.</p> <div style="text-align: right;">  </div>
3	If the input power is 220V AC, the breaker is ON, and Street Racing Stars SDX2-1 cannot boot up, please check if the power wire is broken.



InJoy Motion Corp.

STREET RACING STARS SDX2-1 Service Manual

2. The base fails in homing 40 seconds after the power is on and the PC boots up.

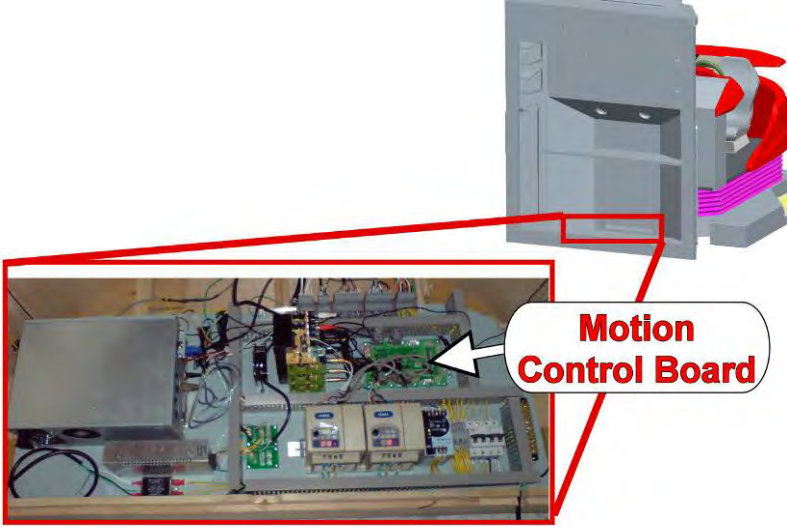
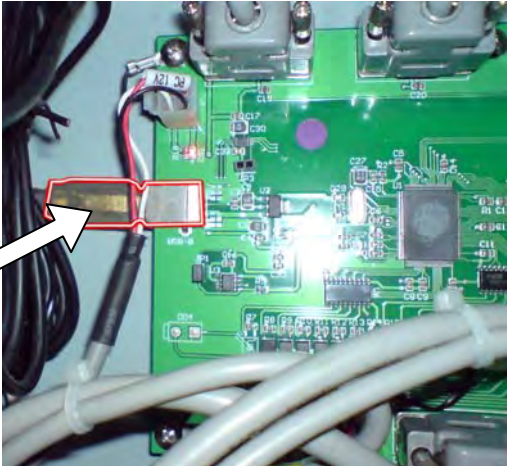
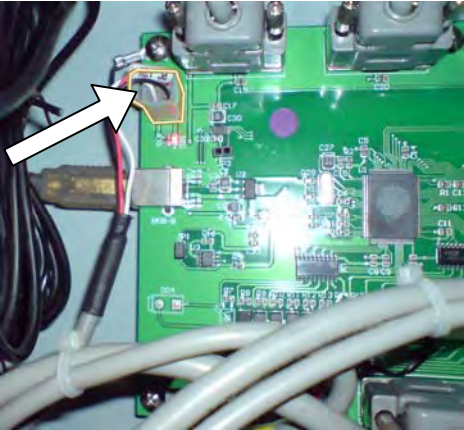
Step	Trouble Shooting Guide
1	<p>Please open the maintenance door, and check the motion control card.</p> 
2	<p>If the green LED on the control card is not lit, please check the USB connector.</p> 
3	<p>If the red LED on the control card is not lit, please check the input power connector.</p> 
4	<p>Please contact our Tech Support at support@imon.com.tw us if the problem is not solved.</p>



InJoy Motion Corp.

STREET RACING STARS SDX2-1 Service Manual

3. The control interface does not respond.

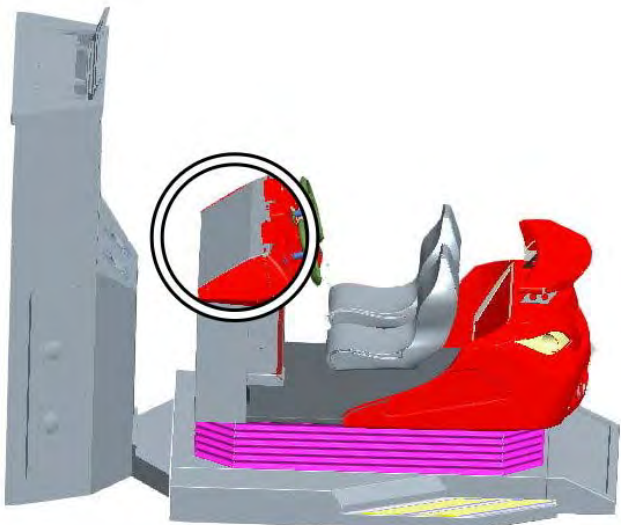
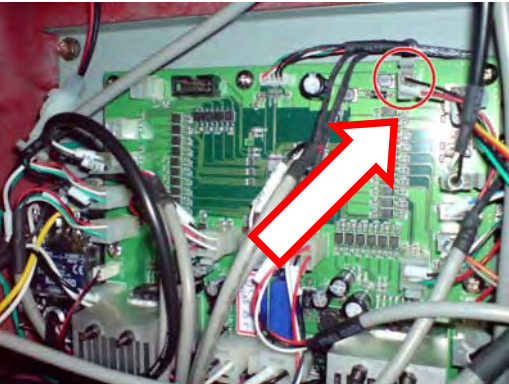
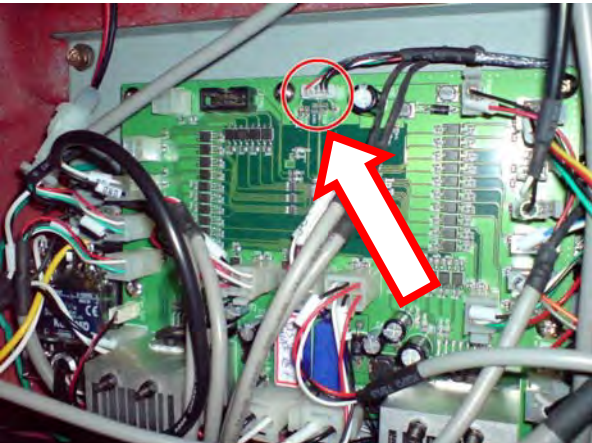
Step	Trouble Shooting Guide
1	<p>Please remove the cover of the Steering Wheel (Please don't power off the game)</p> 
2	<p>Please check if the red LED on the cockpit control board is lit. If the red LED on the cockpit control board is not lit, please check the wire and the connectors. Please replace those broken or damaged with the new ones provided by INJOY. If the red LED on the cockpit control board is lit, reconnect the wire connectors located on the control board and the computer power supply.</p> 
3	<p>Please check if the green LED on the cockpit control board is lit. If the green LED on the cockpit control board is not lit, please check the USB connector or reconnect the wire connectors located on the computer USB port.</p> 



InJoy Motion Corp.

STREET RACING STARS SDX2-1 Service Manual

	If the problem is not solved, please replace the USB wire (length: 3M)
4	<p>If the problem is not solved, please make sure no other game shares this power source.</p> <div style="border: 1px solid black; padding: 5px;"><ol style="list-style-type: none">1. The diameter of the AC power wire must be larger than 2.0 mm.2. The earth line has to be connected.3. No other appliance or game should share this power source on this circuit; otherwise <i>STREET RACING STARS SDX2-1</i> will break down.</div> <p>Please contact our Tech Support at: support@imon.com.tw if the problem is not solved.</p>