



InJoy Motion Corp.

STREET RACING STARS MDX Service Manual

InJoy – STREET RACING STARS MDX

OPERATOR Service Manual

1.	INTRODUCTION	2
2.	SPECIFICATIONS	3
2.1	<i>INJOY–STREET RACING STARS MDX</i> MOTION BASE.....	3
3.	INSTALLATION	4
3.1	SERVICE KIT	4
3.2	SET UP INSTRUCTIONS	4
3.2.1	PRE-INSTALL PREREQUISITES/CAUTIONS	4
3.2.3	INSTALL SIDE STEPS	7
3.2.4	INSTALL HEAD LAMP	9
3.2.5	SET COIN ACCEPTOR	10
3.2.7	DEBIT CARD INSTALL	12
3.2.7	POWER INPUT	13
4.	GAME INTRODUCTION AND SETTING	14
4.1	GAME SETTING (OPERATOR MENU)	14
4.1.1	COIN OPTIONS	15
4.1.2	GAME OPTIONS	16
4.1.3	PEDAL SETTING	17
4.1.4	LANGUAGE SETTING.....	19
4.1.5	SYSTEM TIME SETTING	20
4.1.6	VOLUME SETTING	20
4.1.7	DEVICE TEST.....	21
4.1.8	SOFTWARE UPGRADE.....	21
4.1.9	STATISTIC	25
4.1.10	SAVE & EXIT	26
4.2	GAME INTRODUCTION	27
4.2.1	GAME CONTROL	27
5.	MAINTENANCE	28
5.1	CHASSIS ELECTRONIC COMPONENTS.....	28
5.2	CABINET ELECTRONIC COMPONENTS.....	29
5.3	COCKPIT ELECTRONIC COMPONENTS	30
5.4	MAINTENANCE.....	31
6.	TROUBLE SHOOTING	32



Injoy Motion Corp.

STREET RACING STARS MDX Service Manual

1. INTRODUCTION

Thank you for purchasing the ***Injoy-STREET RACING STARS MDX*** “@Motion System” developed by ***Injoy*** that are well distributed in many markets and territories. This manual will guide you through the set-up and operation of ***Injoy- STREET RACING STARS MDX***, an ultimate game motion system for arcade environments. This unit is different from any other machines of its kind you have ever owned. A fully interactive coin- and swipe card-operated motion simulator, ***Injoy- STREET RACING STARS MDX*** creates a virtual reality environment and provides a truly unique game experience for players. Capable of any motion through 2.0 degrees of freedom (also known as D.O.F.) movement (pitch and roll), this system enables realistic simulation needed for any software program. Rather than pneumatic or hydraulic actuators that require much more maintenance and have been used to power most motion simulators in the past, ***Injoy- STREET RACING STARS MDX*** is powered by electric motors and with ***IMON’s*** patented design, a powerful, mini-motion based platform with physics-based motion dynamics, known as the Hex-Glider. Players will experience realism to an extent that they can “feel” all the exciting actions in a synchronized way as they indulge in the game.

IMON/Injoy is devoted to offer you the most advanced cost-economical and rewarding motion arcade system available. You are welcome to contact us for any questions you may have or for any service we can be of.



InJoy Motion Corp.

STREET RACING STARS MDX Service Manual

2. SPECIFICATIONS

An *InJoy- STREET RACING STARS MDX* includes a complete **Motion Base**.

The dimensions given below are *InJoy-STREET RACING STARS MDX*'s installed footprint.

InJoy-STREET RACING STARS MDX @Motion System Unit

Minimum Installed Footprint **US & GB:** 86.62” x 53.94”
Metric: 2.20cm x 1.37cm

2.1 INJOY-STREET RACING STARS MDX MOTION BASE

<i>InJoy-STREET RACING STARS MDX</i> Motion Base Simulator		
No	Item	Specification
1	Installed Dimensions / Weight (LxWxH)	<ul style="list-style-type: none"> ● 86.62” x 53.94” x 87.42” ● 220cm x 137cm x 222cm
2	Motion system	<ul style="list-style-type: none"> ● 2.0 degree motion (D.O.F.) mini-motion based: AC powered, Motor Driven Actuators
3	Control inputs/feedback	<ul style="list-style-type: none"> ● Steering Wheel ● Gear ● Fuel Pedal / Brake Pedal ● Yellow Button for Start / Turbo ● Red Button for View ● Motion Stop Switch
4	Player Weight Limit	<ul style="list-style-type: none"> ● 150 kgs
5	Center of Gravity	<ul style="list-style-type: none"> ● Directly over 2 axis
6	Motors	<ul style="list-style-type: none"> ● 3Φ220VAC x 2 motors
7	Power Requirements – Plugs located at the bottom of the motion base behind the monitor.	<ul style="list-style-type: none"> ● Power requirements in USA: 110 VAC, 24.6 Amps, 50/60 Hz (Transformer needed) ● Power requirements in EURO: 220 VAC, 12.3 Amps, 50/60 Hz.
8	Max Watt Consumed Rated Watt Consumed	<ul style="list-style-type: none"> ● 1707 W ● 1365 W
9	Audio	<ul style="list-style-type: none"> ● 30 watts Speakers x 2, 4 ohm ● 1 Sub-Woofer ● 2 Super Sub-Woofer under seat
10	Monitor	<ul style="list-style-type: none"> ● 42” LCD Monitor ● 15 pin DB Connection
11	Computer System	<ul style="list-style-type: none"> ● Windows Embedded Operating System ● High Resolution Graphics Accelerator Card.



Injoy Motion Corp.

STREET RACING STARS MDX Service Manual

3. INSTALLATION

3.1 SERVICE KIT

The following items should be included with the shipment of your *Injoy-STREET RACING STARS MDX*:

Service Kit	
Description	Qty
<i>Injoy-STREET RACING STARS MDX</i> Service Manual	1
Maintenance Box Key	1
Coin Box Key	1
Special Wrench	1

3.2 SET UP INSTRUCTIONS

3.2.1 PRE-INSTALL PREREQUISITES/CAUTIONS

Injoy-STREET RACING STARS MDX is designed for indoor use only. To ensure trouble-free and safe operation, the following conditions are recommended:

1. The motion system must be located out of direct exposure to sunlight, high humidity, dust, salt mist, high heat, or extreme cold. If installed in an extremely hot location, allow additional clearance between ventilation slots in the game and any structure or object that would tend to restrict air circulation.
2. The motion system produces tremendous forces onto the motion base, which may be moved around on the floor if not properly installed. Before placing *STREET RACING STARS MDX* motion system on the ground, make sure the floor space is flat and before operating the game, make sure the brackets are tightly installed. If you have questions regarding any installation requirements, contact our tech support (+886-2-2267-6317 Ext. 283 or E-mail: support@imon.com.tw) at *Injoy* before proceeding.



InJoy Motion Corp.

STREET RACING STARS MDX Service Manual

3.2.2 INSTALL CENTER PLATE

Please follow the steps to install Center Plate.

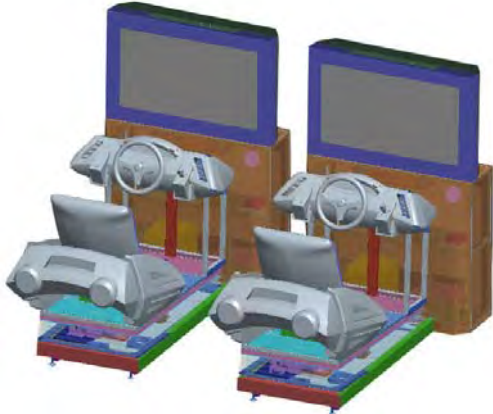
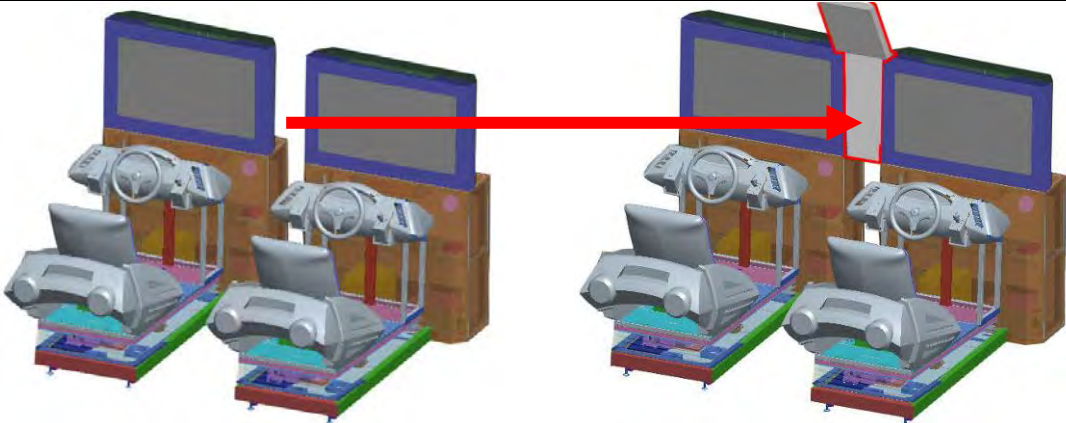
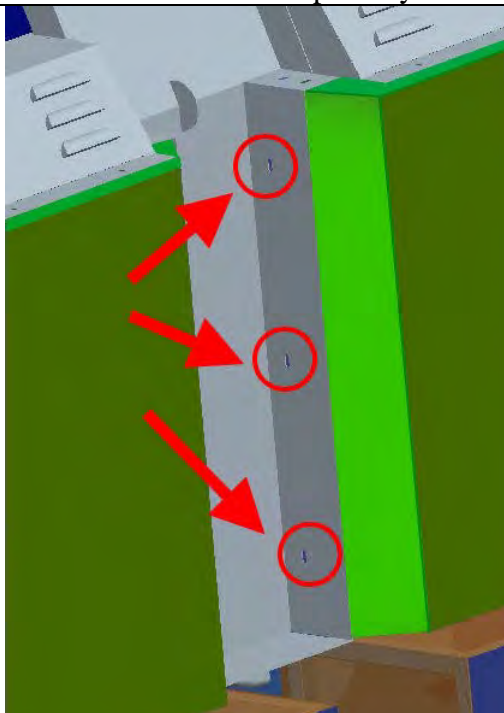
Step	Description & Diagram
1	<p>Move two units side by side.</p> 
2	<p>Place the plate in the center of two STREET RACING STARS MDX. Adjust the gap of two units, if the plate can't install.</p> 
3	<p>Fix the two sides of the plate by fastening the screws.</p> 



InJoy Motion Corp.

STREET RACING STARS MDX Service Manual

4

Plug in Center Acrylic Sheet (Figure A), and then fix it by four screws (Figure B).

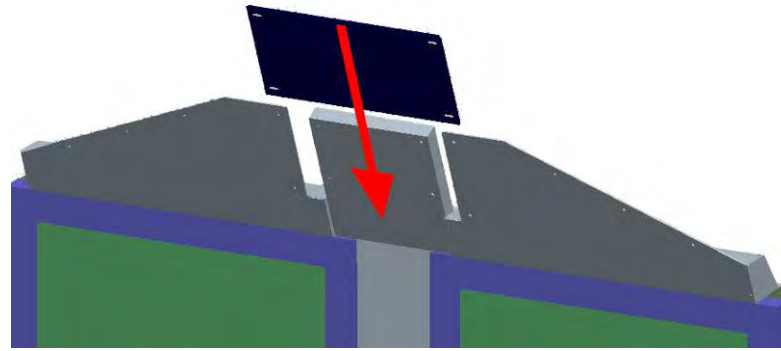

Figure A

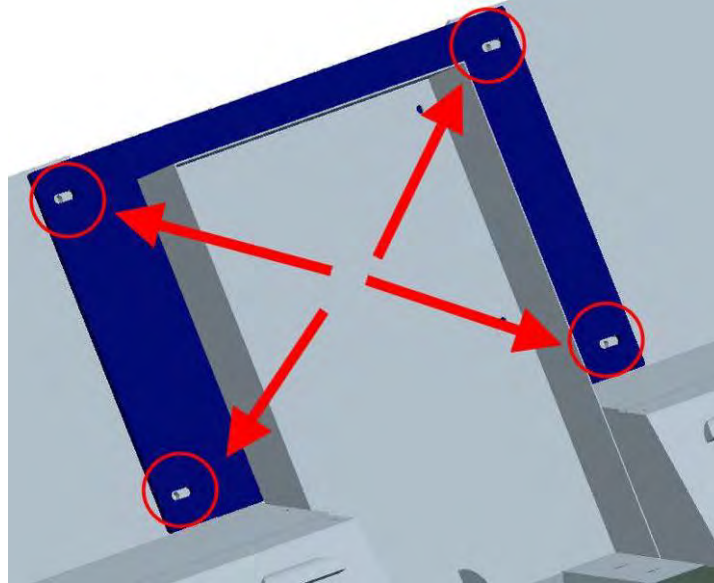

Figure B



InJoy Motion Corp.

STREET RACING STARS MDX Service Manual

3.2.3 INSTALL SIDE STEPS

Please follow the steps to install Side Step.

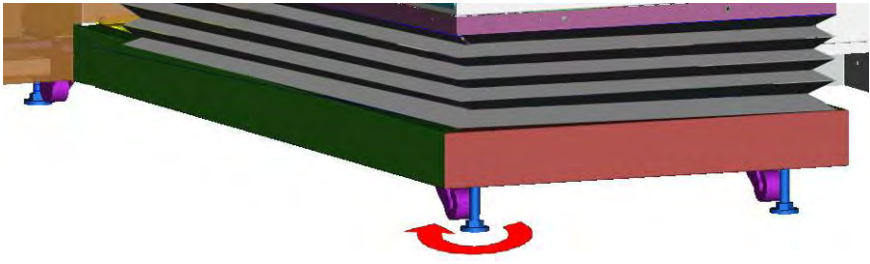
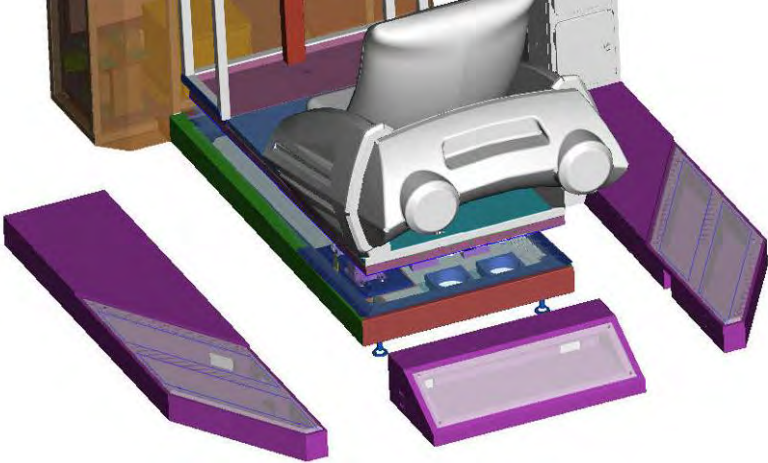
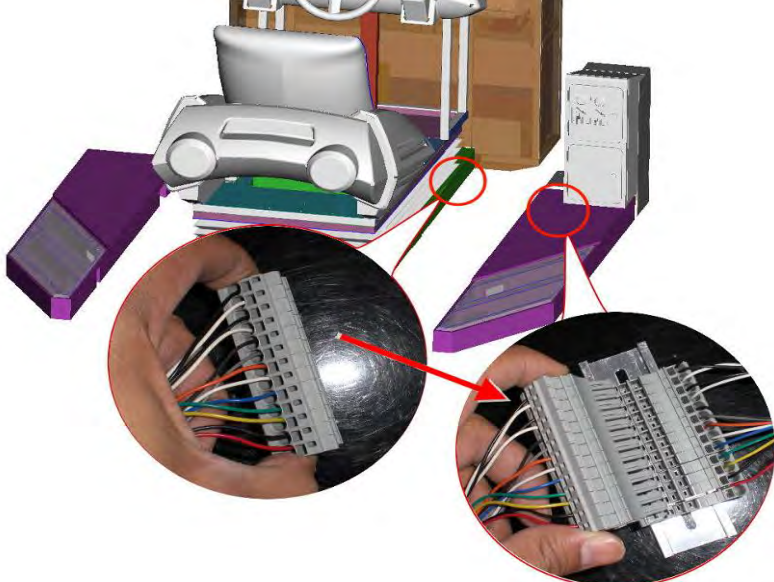
Step	Description & Diagram
2	<p>Adjust unit stands by Hex wrench to make sure STREET RACING START MDX motion system is placed flat on the ground and the brackets tightly installed.</p> 
3	<p>Place the two side steps and the back lamp near the base, and then connect Light connectors.</p> 
4	<p>Find the two connectors, one is located under the motion base in the front right hand side. The other connector is located in the right side of the side step (under coin box). Then connect it.</p> 



InJoy Motion Corp.

STREET RACING STARS MDX Service Manual

Push the two side steps and the back lamp close to the base, and then fix it by L type plate

5

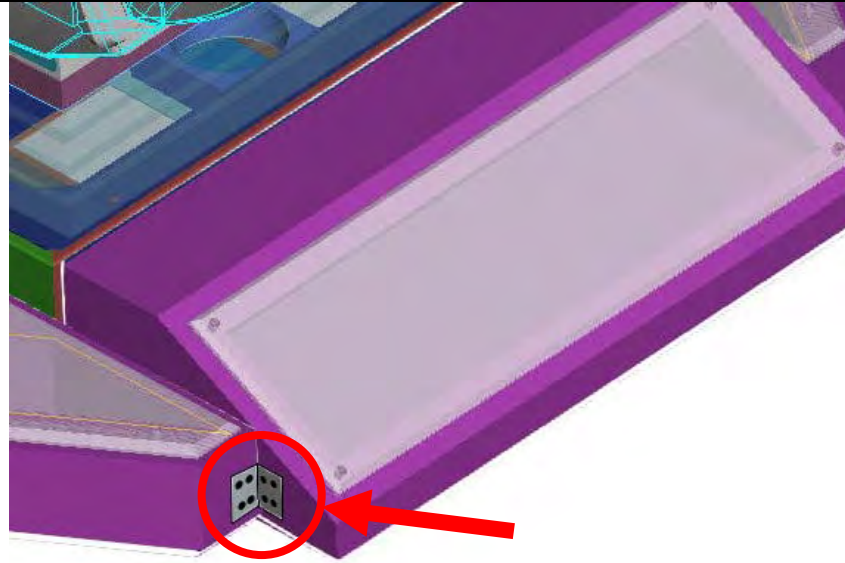



InJoy Motion Corp.

STREET RACING STARS MDX Service Manual

3.2.4 INSTALL HEAD LAMP

Please follow the steps to install the Head Lamp.

Note: Be careful when installing the Acrylic Sheet, please don't damage it.

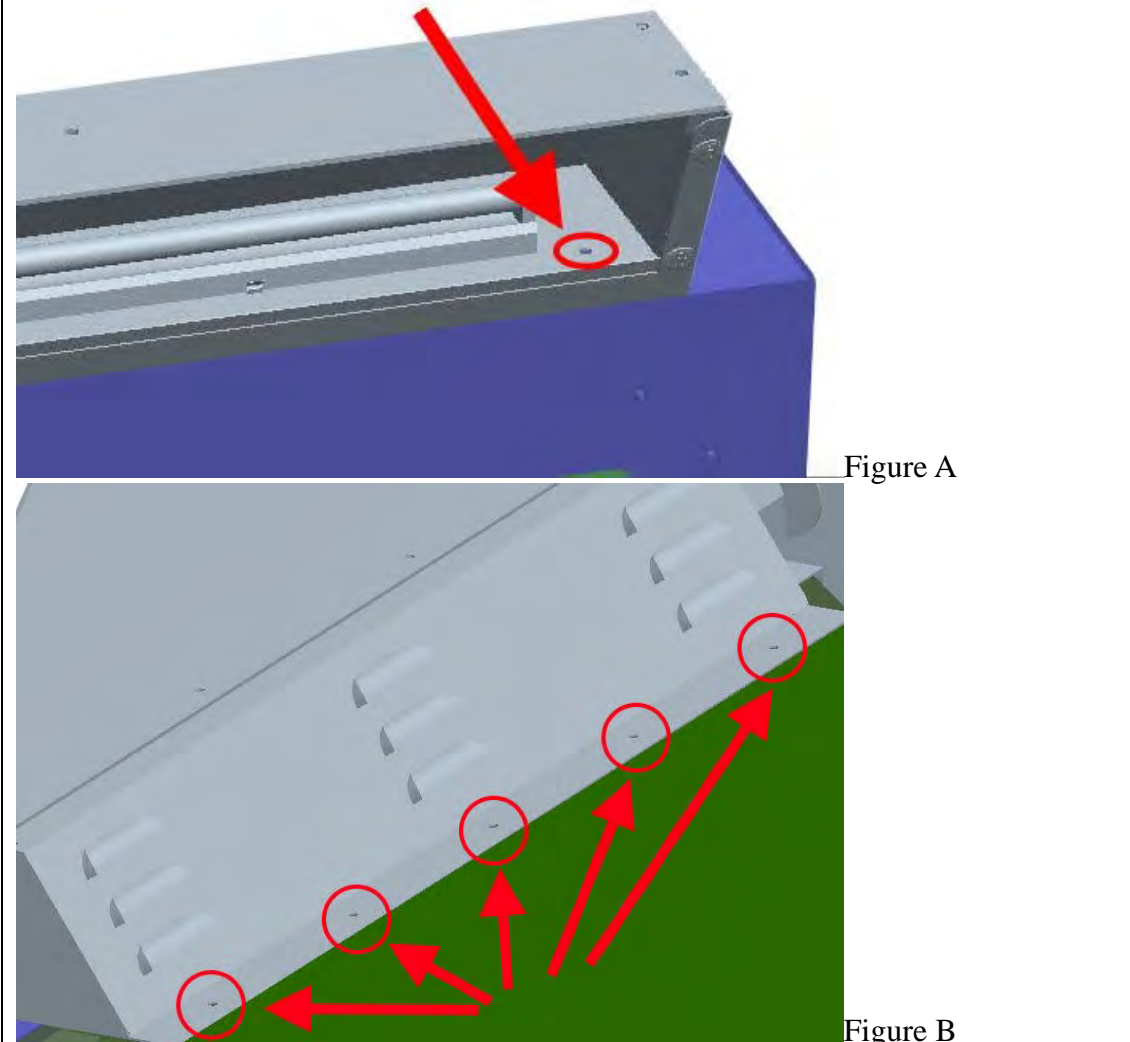
Step	Description & Diagram
1	<p>Connect the power connectors of the Head Lamp as shown in Figure</p> 
2	<p>Place the Head Lamp on top of the LCD screen, and then fasten it with fix screws as shown in Figure A and Figure B</p>  <p style="text-align: right;">Figure A</p> <p style="text-align: right;">Figure B</p>



InJoy Motion Corp.

STREET RACING STARS MDX Service Manual

3	Place the Acrylic Sheet on the Light Box, and then fasten it with four fix screws.

3.2.5 SET COIN ACCEPTOR

Please follow the steps to set-up the coin acceptor.

Step	Description & Diagram
1	Pull up the slider of the coin acceptor
2	Insert the coin into the coin acceptor.



InJoy Motion Corp.

STREET RACING STARS MDX Service Manual

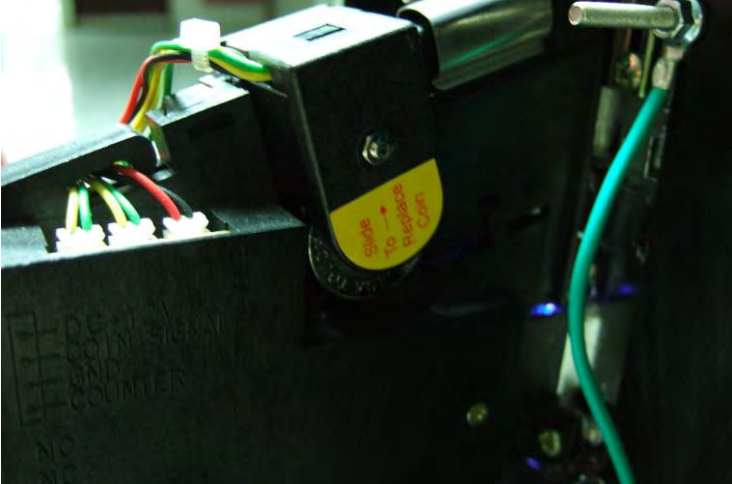
3	<p>Push down the slider to fix the coin acceptor.</p> 
4	<p>The coin acceptor is set up then, and can take the coin you want.</p> 





InJoy Motion Corp.

STREET RACING STARS MDX Service Manual

3.2.7 DEBIT CARD INSTALL

If the unit needs to be installed with a debit card reader, Figure 4 below illustrates the connection.

Steps	Description & Diagram
1	<p>Find “Coin 1” connector located inside the Coin Box</p> 
2	<p>Follow the signal connection as shown in below figure to install.</p> 



InJoy Motion Corp.

STREET RACING STARS MDX Service Manual

3.2.7 POWER INPUT

STREET RACING STARS MDX has a single power cord. The motion base requires one dedicated (25-Amp) circuit for (1 Φ 210~230VAC) power source.



Note: 1. AC Power Wire Diameter must be greater then 2.0mm

2. No other appliance or game should share this power source on this circuit, otherwise *STREET RACING STARS MDX* will break down.



InJoy Motion Corp.

STREET RACING STARS MDX Service Manual

4. GAME INTRODUCTION AND SETTING

4.1 GAME SETTING (OPERATOR MENU)

To access OPERATOR MENU, after the Power is switched ON and the screen shows “insert coin”, find the OPERATOR SWITCH located inside the coin box door and move it to “ON” position (Figure 4-1), and continue in the OPERATOR MENU (Figure 4-2).

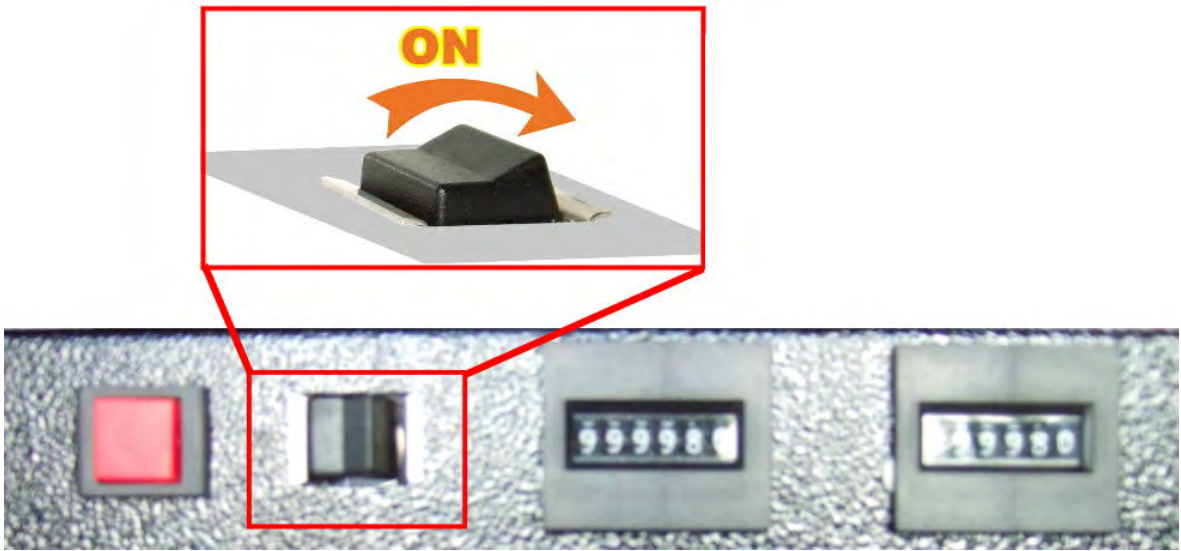

Figure 4-1 Operator Switch

From the OPERATOR MENU, you have direct access to game and operator settings. From sub-menus (listed below), you have access to general game control settings. The definitions of the Operator Menu and its sub-menu are detailed below:



Figure 4-2 Operator Menu



InJoy Motion Corp.

STREET RACING STARS MDX Service Manual

4.1.1 COIN OPTIONS

The “*Coin Options*” sub-menu allows you to set all coin options on your *InJoy- STREET RACING STARS MDX* (Figure 4-3).

1. “*Coins per Play*” allows you to set how many coins it will take for a player to start a game. The factory default setting value is 4 coins per play.
2. “*Coins per Continue*” allows you to charge a different price for continue-play from the first game play. The factory default setting value is 4 coins per play.
3. “*Currency Type*” is not to select the currency of a country, but allows selection of the forms of currency i.e. coins or bills you wish your *InJoy- STREET RACING STARS MDX* accepts. The factory default setting is Coin (combined into one setting) and another setting is the Bill Acceptor or Debit Cards. The coin acceptor is an industrial standard product.
4. “*Coins per Pulse (Coin Acceptor 1)* (Figure 4-4)” allows you to adapt different currency acceptors that are pulse specific to your *InJoy- STREET RACING STARS MDX*. The default value is 1.
5. “*Coins per Pulse (Coin Acceptor 2)* (Figure 4-4)” allows you to adapt different currency acceptors that are pulse specific to your *InJoy- STREET RACING STARS MDX*. The default value is 1.
6. “*Winner Continue*” allows you to setup if Winner wants to continue game, insert coin to continue or free to continue. This setup is for single player.
7. “*Winner Continue (Net)*” allows you to setup if Winner wants to continue game, insert coin to continue or free to continue. This setup is for single player.

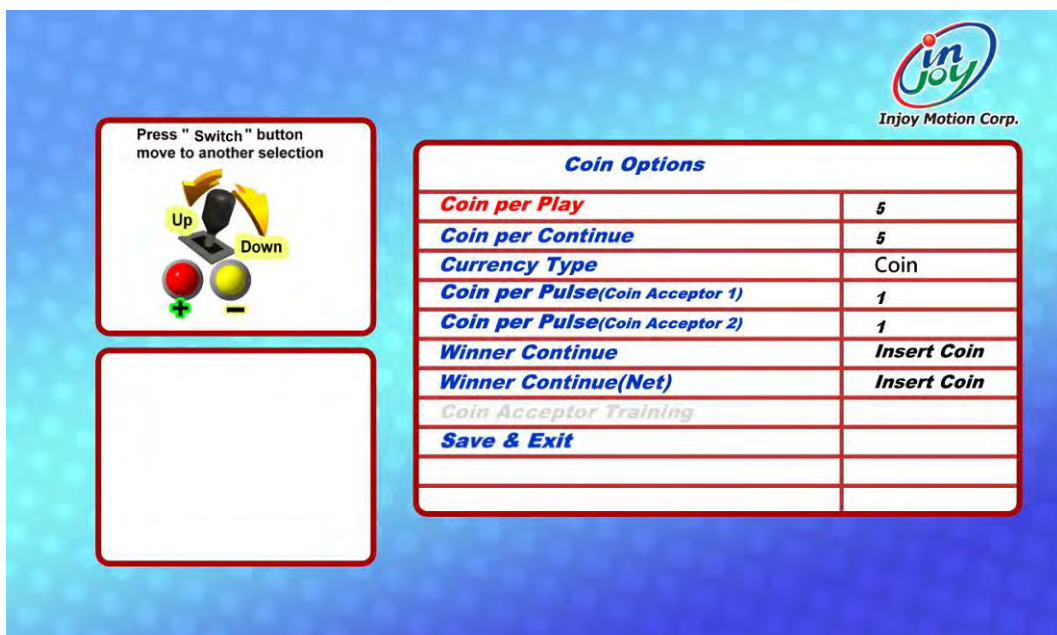



InJoy Motion Corp.

STREET RACING STARS MDX Service Manual

Figure 4-3 “Coin Options” sub-menu



Figure 4-4 Coin Acceptor Number

4.1.2 GAME OPTIONS

“*Game Options*” sub-menu offers settings that you can adjust for each individual software title installed on your *InJoy- STREET RACING STARS MDX* (Figure 4-5).

1. “*Continue Timer Length*” adjusts the amount of time for the player to decide to continue playing after their game has ended. This can be adjusted by using the “+” or “-” buttons as shown in Figure 4-5.
2. “*Game Show Operation*” enables free game play by pressing “Switch” button.
3. “*Clear High Scores*” deletes all high scores and returns to the default settings. (Figure 4-6)

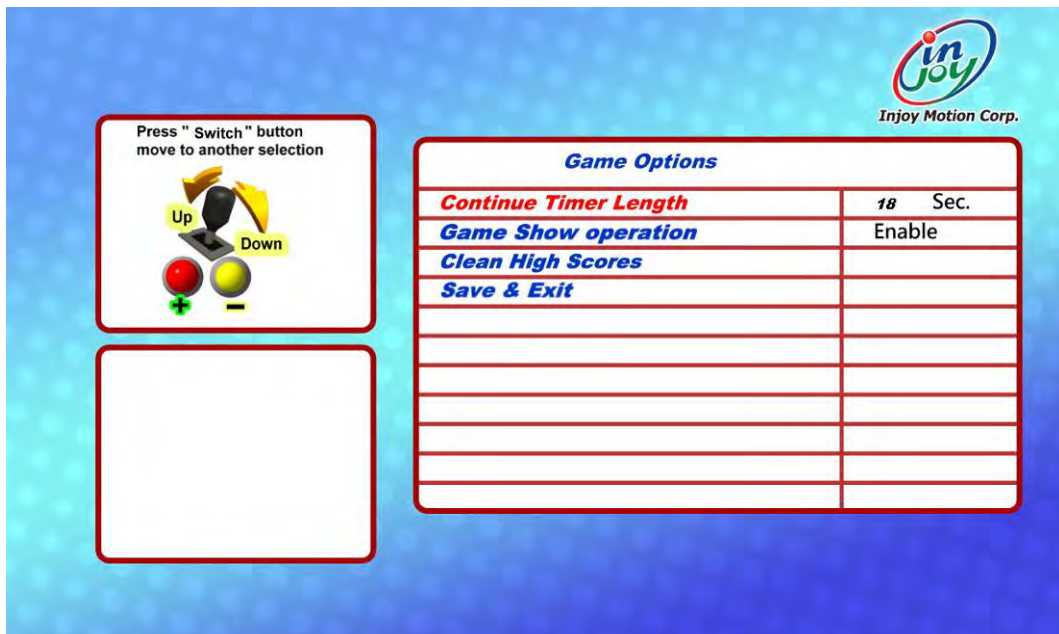

Figure 4-5 “*Game Options*” sub-menu



InJoy Motion Corp.

STREET RACING STARS MDX Service Manual

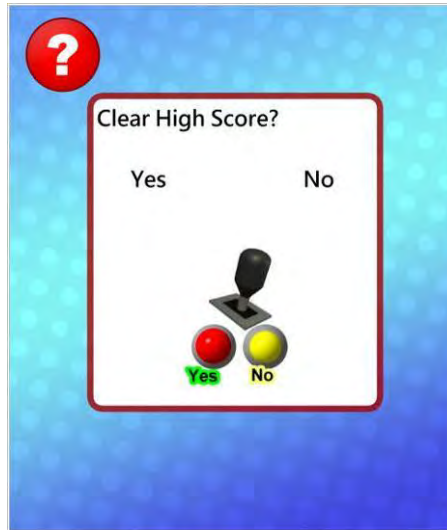

Figure 4-6 “Clear High Scores” Window

4.1.3 PEDAL SETTING

To calibrate the Throttle, follow the directions on the screen and go through these steps (Figure 4-7 ~ Figure 4-10):

1. Hold the “Calibrate” button on the Panel to calibrate the pedal and brake.
2. Release the Brake and Pedal, then press “Next” button.
3. Press the Brake and Pedal to limit and then press “Next” button.
4. After finished the calibration, press “Exit” button to exit calibrate.

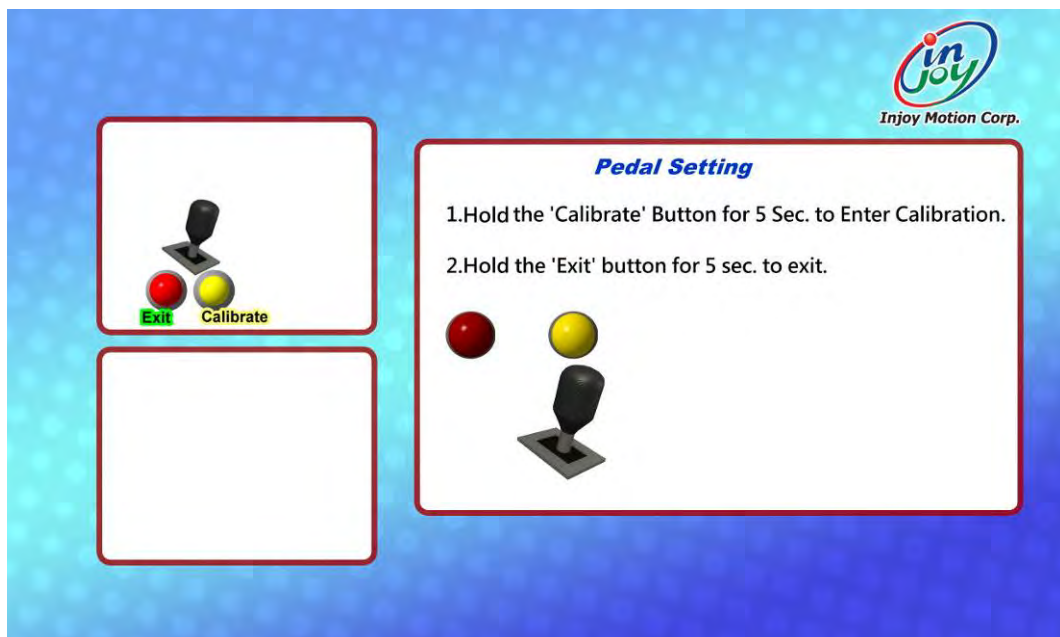

Figure 4-7 Pedal Setting



InJoy Motion Corp.

STREET RACING STARS MDX Service Manual

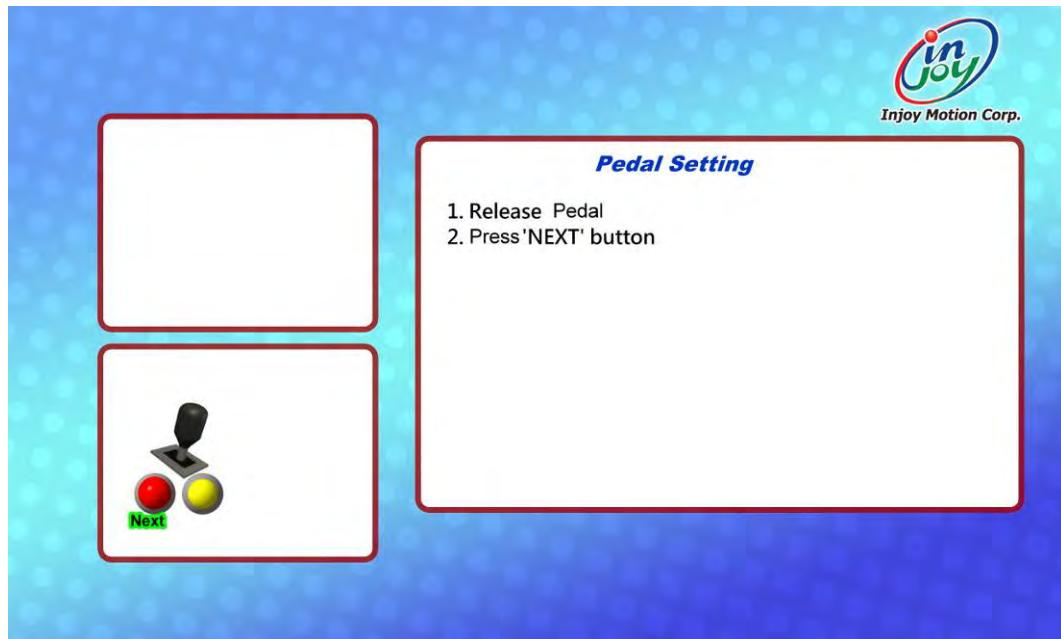

Figure 4-8 Calibrate Pedal

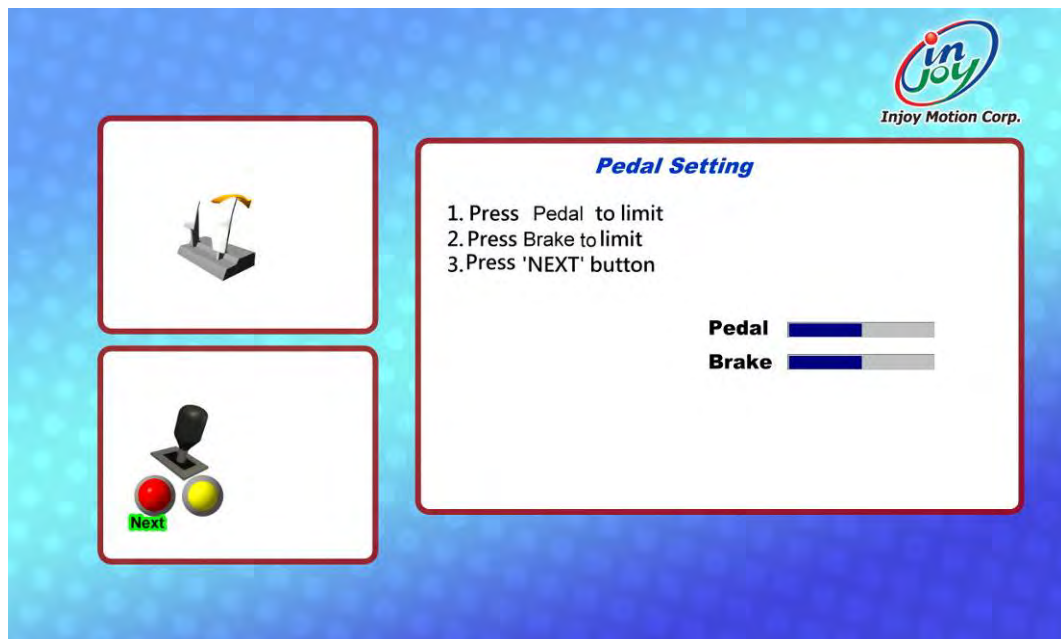

Figure 4-9 Calibrate Pedal



InJoy Motion Corp.

STREET RACING STARS MDX Service Manual

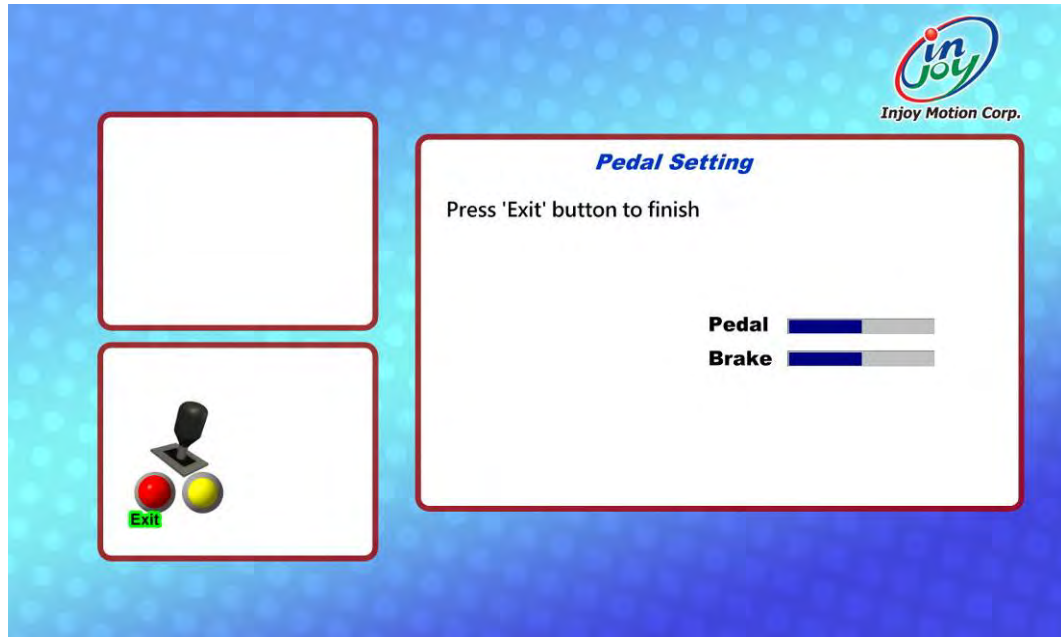

Figure 4-10 Finish calibration

4.1.4 LANGUAGE SETTING

Language can be adjusted using the “+” or “-” buttons (Figure 4-11) to change game language. Currently, English and Chinese are available.

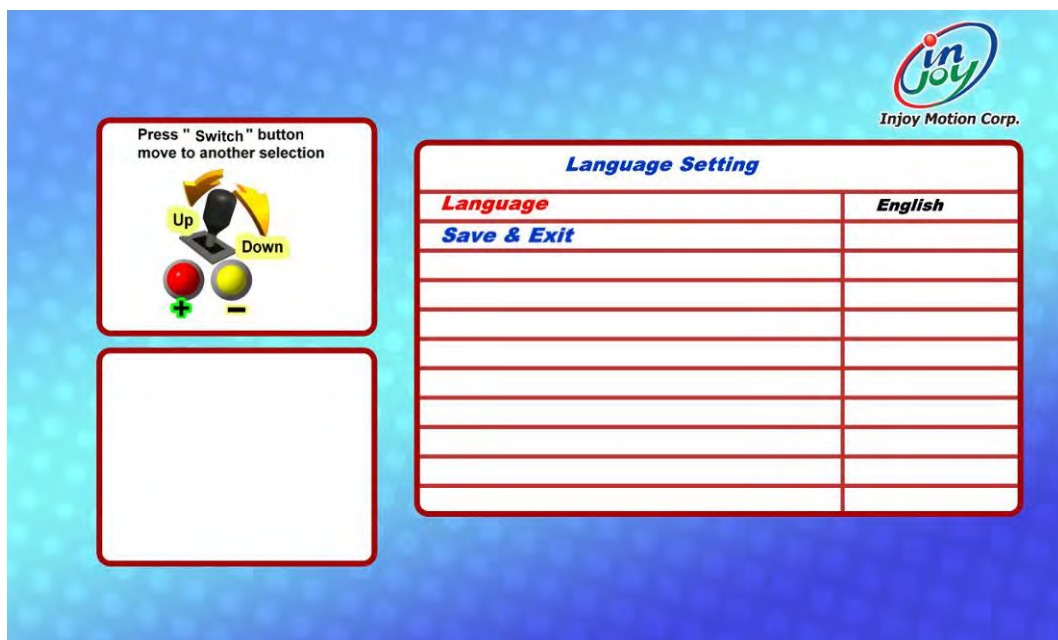

Figure 4-11 “Language Setting” sub-menu



InJoy Motion Corp.

STREET RACING STARS MDX Service Manual

4.1.5 SYSTEM TIME SETTING

Setting the system time can be accomplished using the “switch” button to choose, followed by the “+” or “-” buttons (Figure 4-12) to change date or time. Time is displayed in 24 hour or military time.

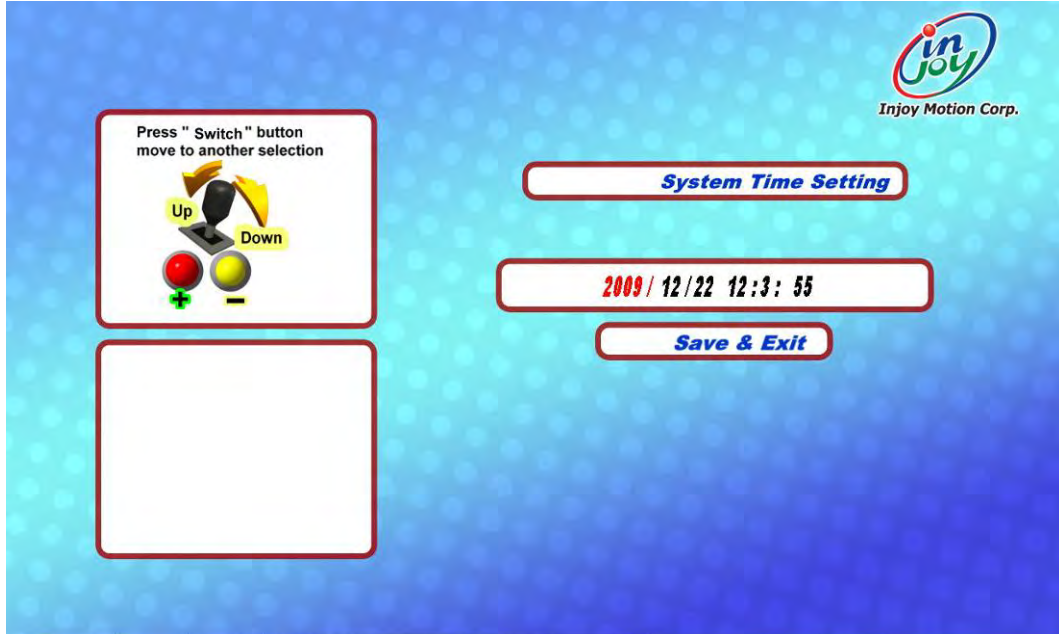

Figure 4-12 “System time Setting” sub-menu

4.1.6 VOLUME SETTING

“Volume setting” can adjust the system volume (Figure 4-13).

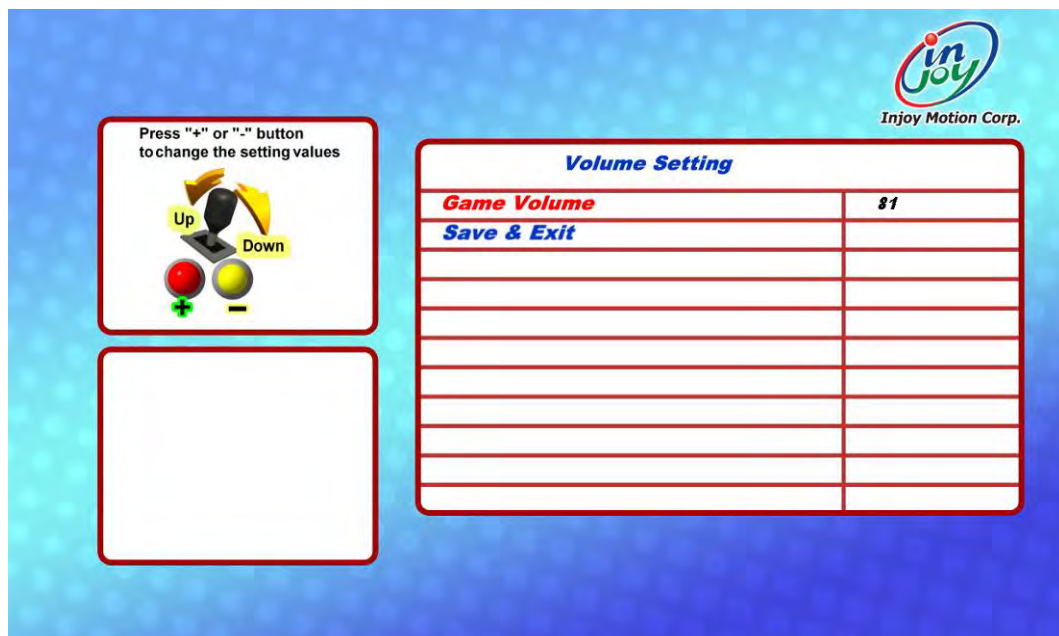

Figure 4-13 “Volume Setting” sub-menu



InJoy Motion Corp.

STREET RACING STARS MDX Service Manual

4.1.7 DEVICE TEST

“Device Test” tests whether “Coin Acceptor, Free Play button” can work or not (Figure 4-14).

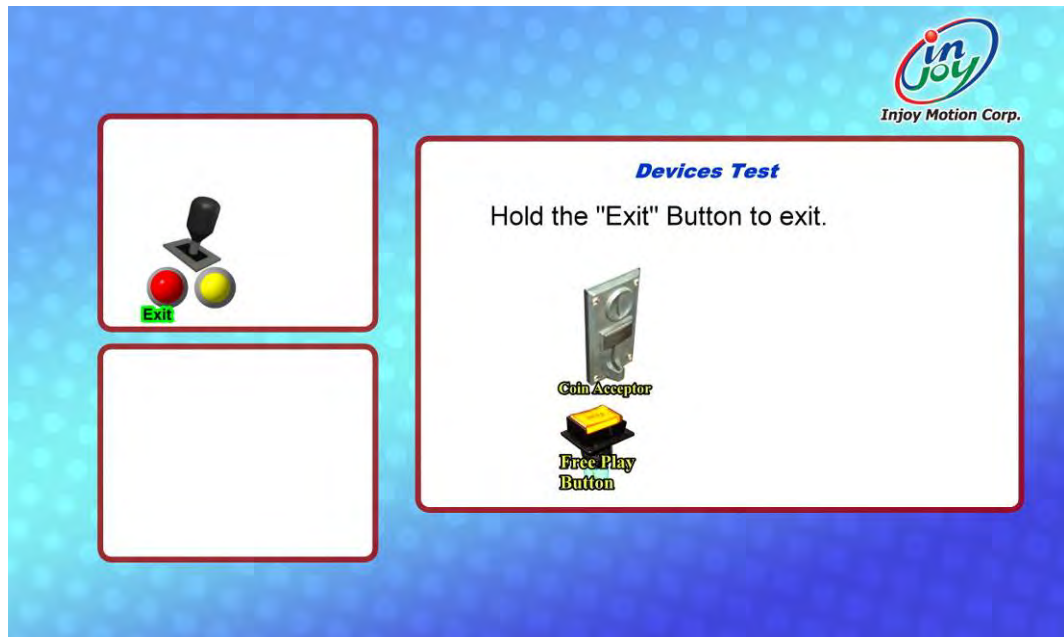

Figure 4-14 “Device Test” sub-menu

4.1.8 SOFTWARE UPGRADE

Any software upgrades and/or new software game titles will be downloaded to your *InJoy - STREET RACING STARS MDX* through the use of USB Flash Disk provided by *InJoy* or your distributor. The following explains this simple procedure, found in the Operator Menu.

1. Unfasten the screws (arrows as shown in the Figure 4-15), and then remove the case (Figure 4-16).

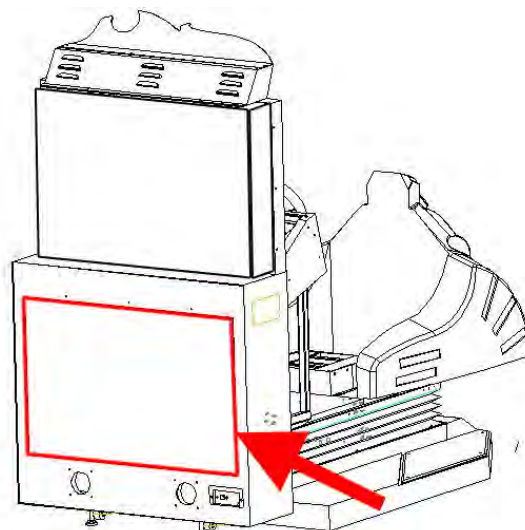

Figure 4-15 unfasten the screws



InJoy Motion Corp.

STREET RACING STARS MDX Service Manual

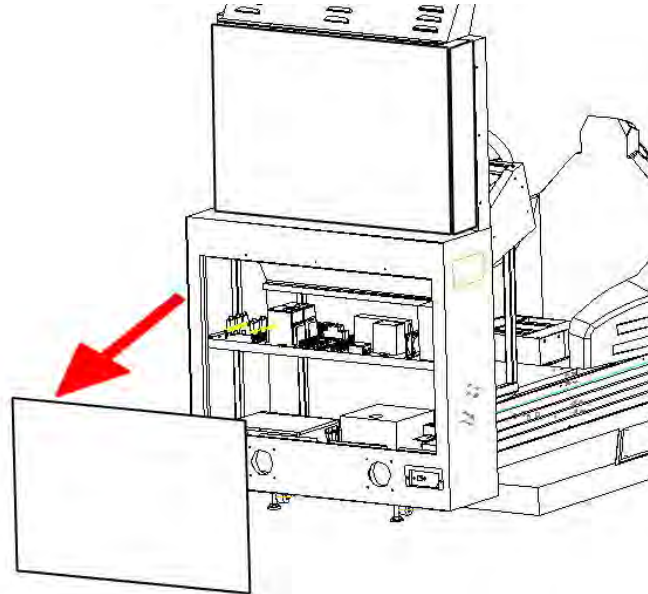

Figure 4-16 Remove the case

2. Locate the system's PC (Industrial PC): Referring to Figure 4-17, open the front case of the chassis located at the bottom of the motion base. You can see the PC is installed at the left corner.

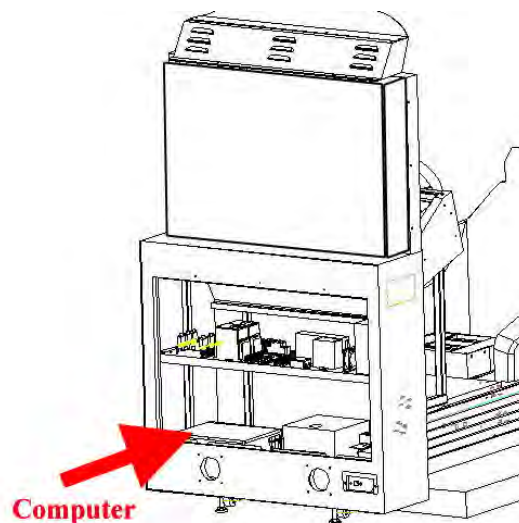

Figure 4-17 Locate the system's PC (Computer)

3. Plug in the USB Flash Disk. (Only use the USB Flash Disk provided by **InJoy** or your distributor to upgrade/download the software. The USB Flash Disk from unauthorized sources might seriously damage the system.)
4. On Operator Menu, press the “*select*” button on the panel (please refer to Figure 4-2) to select “*Software Upgrade*” sub-menu.
5. Press the “*upgrade*” button on the panel (Figure 4-18), and your software system will begin to upgrade/download the software automatically (Figure 4-19).



InJoy Motion Corp.

STREET RACING STARS MDX Service Manual

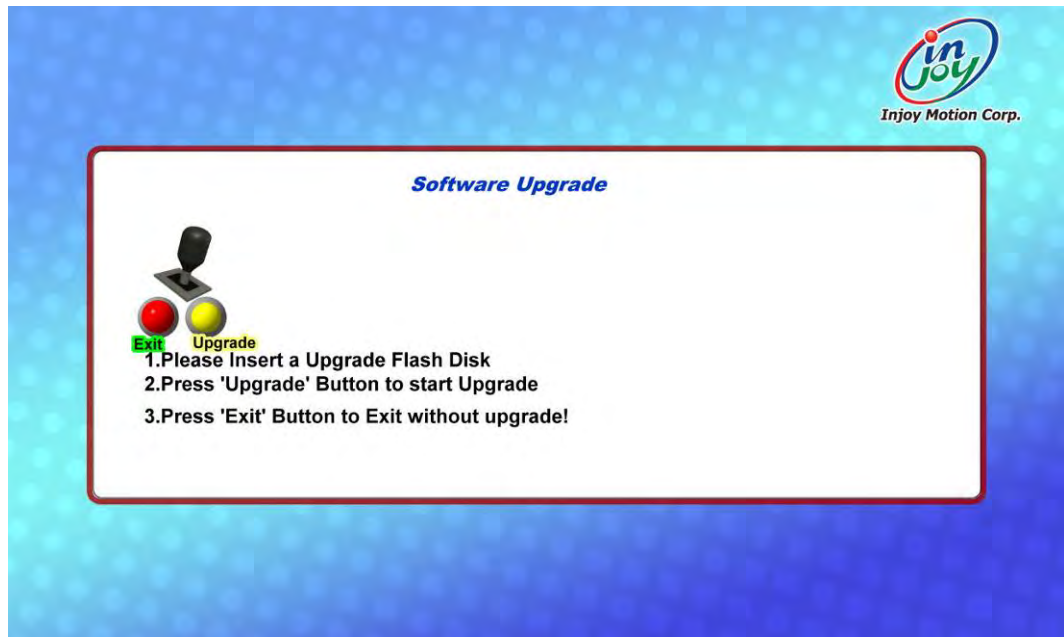

Figure 4-18 “Software Upgrade” sub-menu

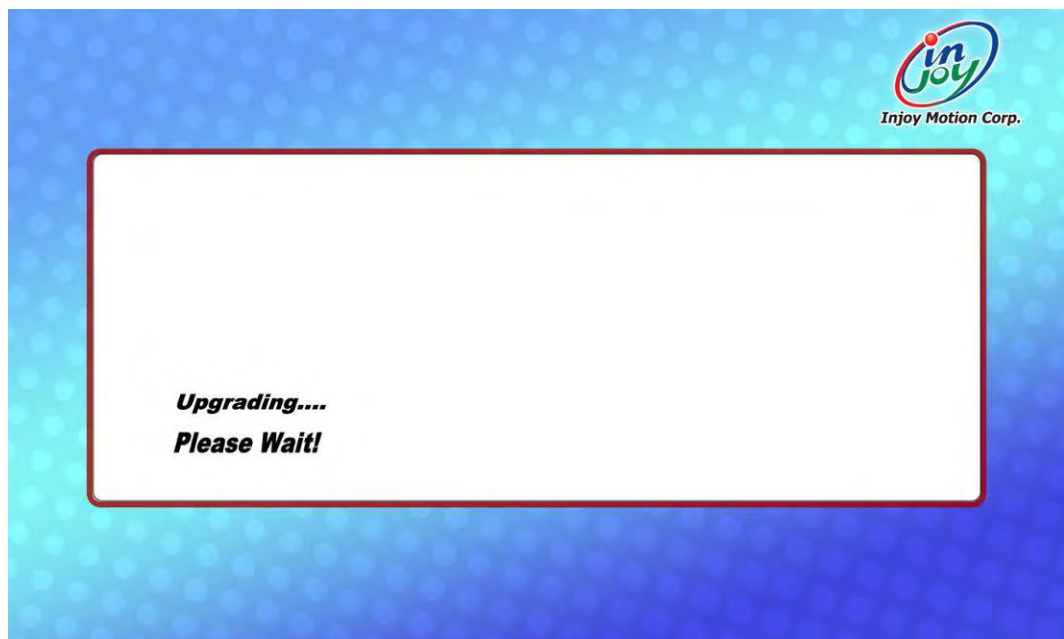

Figure 4-19 “Software Upgrading” Window

Progress will be indicated on screen and you will be notified when download is complete (Figure 4-20). (If you didn't plug the USB Flash Disk onto the PC, it will display an “*Upgrade fails*” window (Figure 4-21).



InJoy Motion Corp.

STREET RACING STARS MDX Service Manual

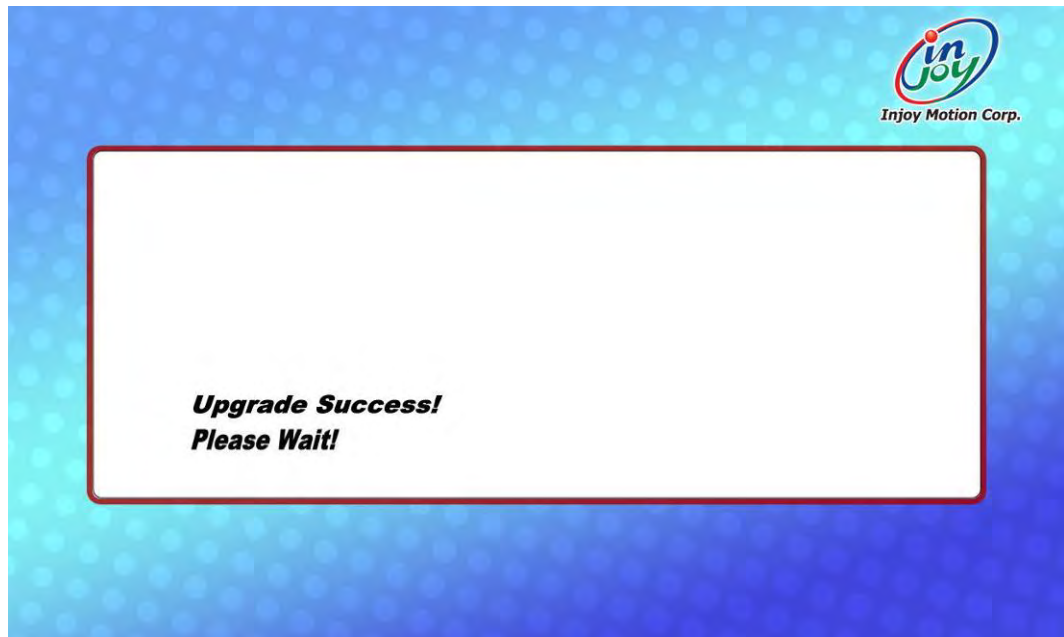

Figure 4-20 “*Upgrade Success*” Window

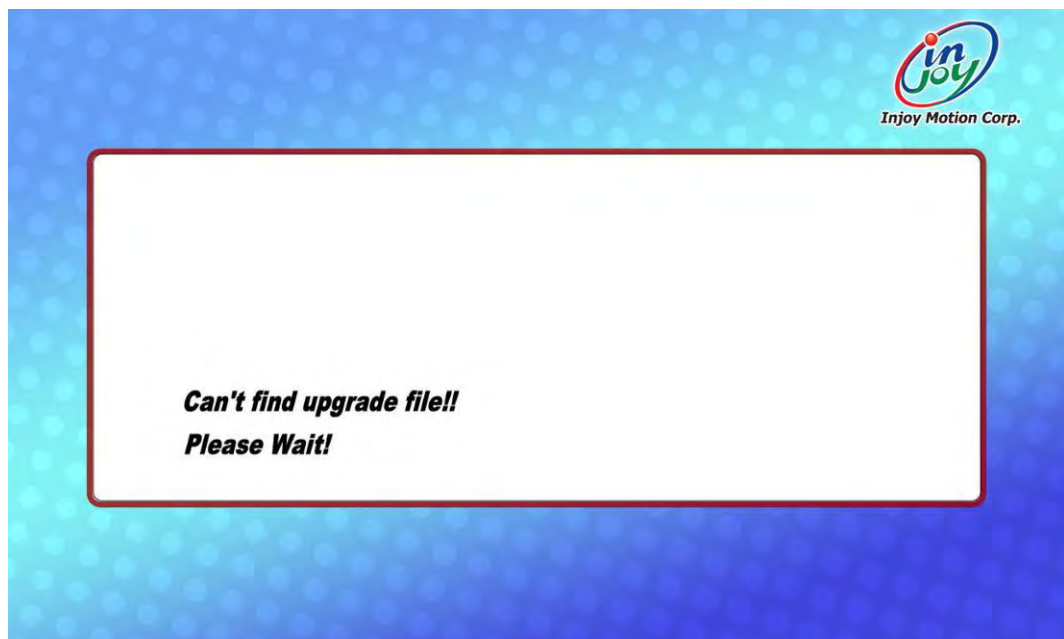

Figure 4-21 Upgrade fails

6. If you wish to cancel upgrade process, press the” Exit” button (Figure 4-18) to exit “*Software Upgrade*” sub-menu.

If the screen shows “Can’t find upgrade file” when you have upgraded the file, please pull out the motion card USB cable. Then pull out the USB disk and try again.



InJoy Motion Corp.

STREET RACING STARS MDX Service Manual

4.1.9 STATISTIC

The information related to playing game is given (Figure 4-22) as follows:

1. “Coin Count” to show the amount of coins inserted.
2. “Free Play Count” to show the number of times the Free Play has been pressed.
3. “Total Play” to show the number of times the game has been played (Total Play = Starts + Continues).
4. “Starts” to show the number of time the game has started.
5. “Continues” to show the number of time the game has been continued.
6. “Average Time per Credit” to show the average time per one coin.
7. “Average Time per Player” show the average time per one player.
8. “Clear Statistic” to clear information in “Statistic” (all value is zero after clearing)

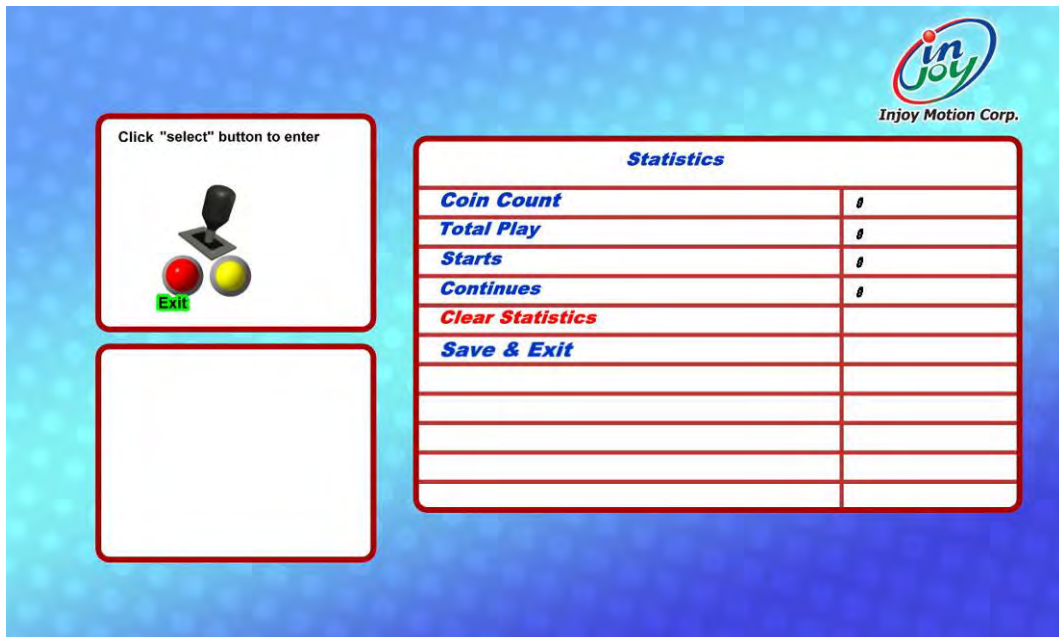

Figure 4-22 “Statistic” sub-menu



InJoy Motion Corp.

STREET RACING STARS MDX Service Manual

4.1.10 SAVE & EXIT

After the setup is completed, the system needs to exit. Please select “Save & Exit”, and then the screen will prompt “Yes” or “NO”. If you press “YES” (Figure 4-23), the system will show” Shutdown.....!! Please turn the Operator switch to OFF position.” (Figure 4-24)

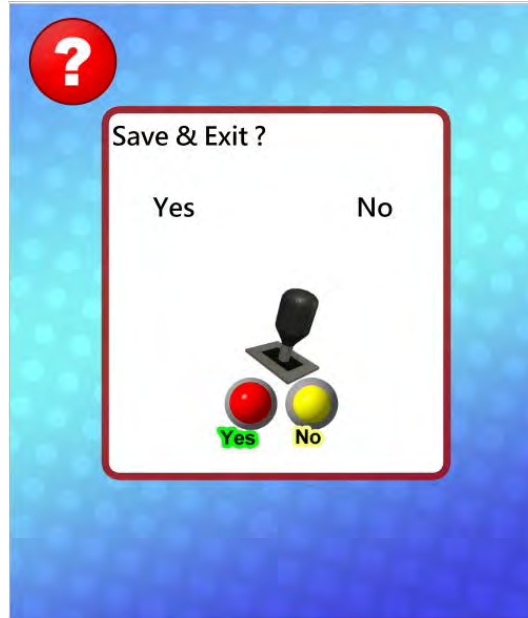

Figure 4-23 Save & Exit window

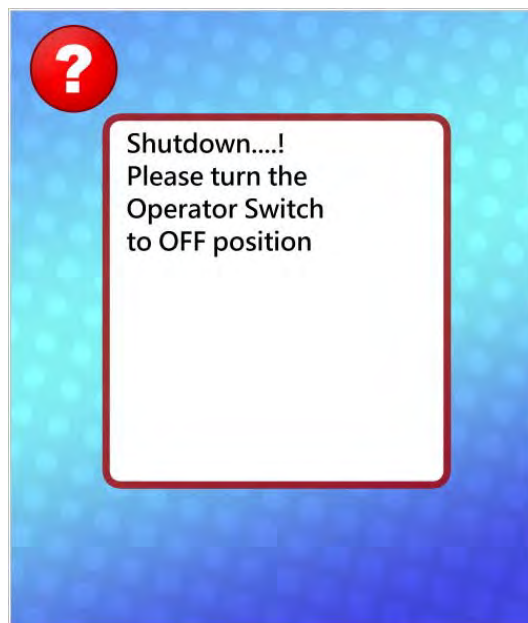

Figure 4-24 Shutdown prompt



Injoy Motion Corp.

STREET RACING STARS MDX Service Manual

4.2 GAME INTRODUCTION

4.2.1 GAME CONTROL

The player uses the steering wheel, throttle and buttons (Figure 4-25) to control the boats. Click the yellow button to start the game. While playing, click the yellow button to turbo, and click the red button to change View on the Screen.



Figure 4-25 Game control interfaces



InJoy Motion Corp.

STREET RACING STARS MDX Service Manual

5. MAINTENANCE

5.1 CHASSIS ELECTRONIC COMPONENTS

Figure 5-1 ~ Figure 5-3 are the electronic components of the chassis.

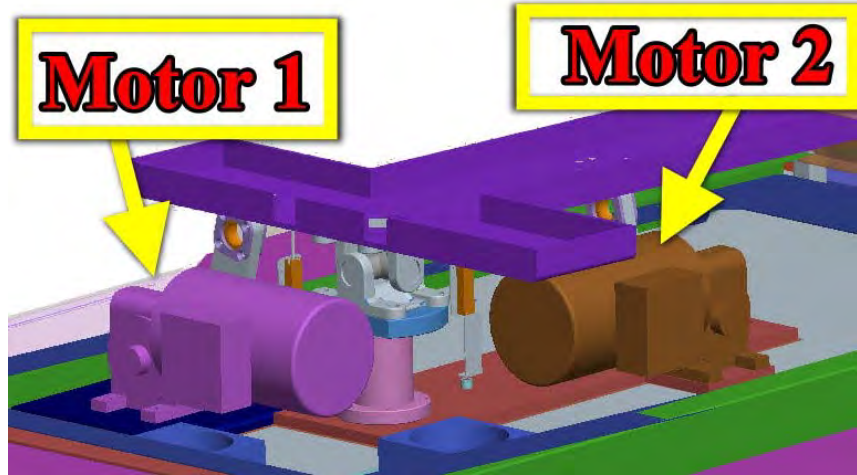

Figure 5-1 Chassis Electronic Components-1

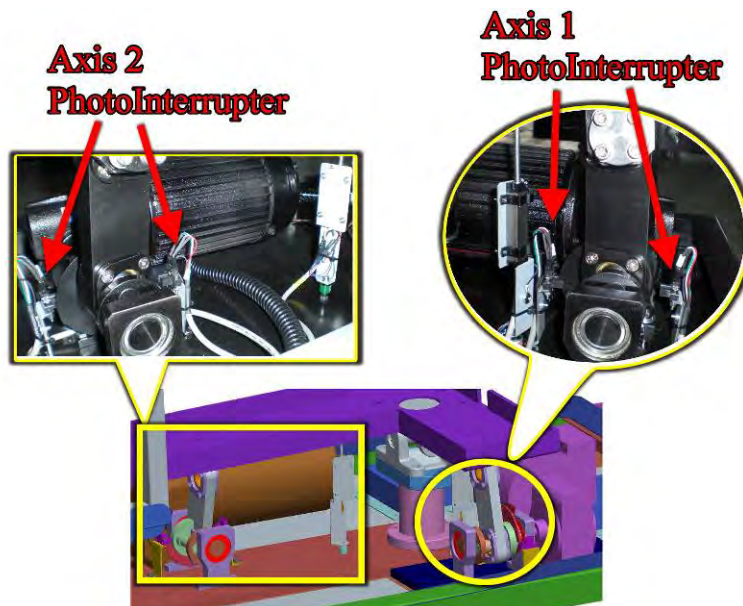

Figure 5-2 Chassis Electronic Components-2



InJoy Motion Corp.

STREET RACING STARS MDX Service Manual



Figure 5-3 Chassis Electronic Components-3

5.2 CABINET ELECTRONIC COMPONENTS

Figure 5-4 are the Cabinet electronic components.

Figure 5-5 are the LCD screen electronic components.

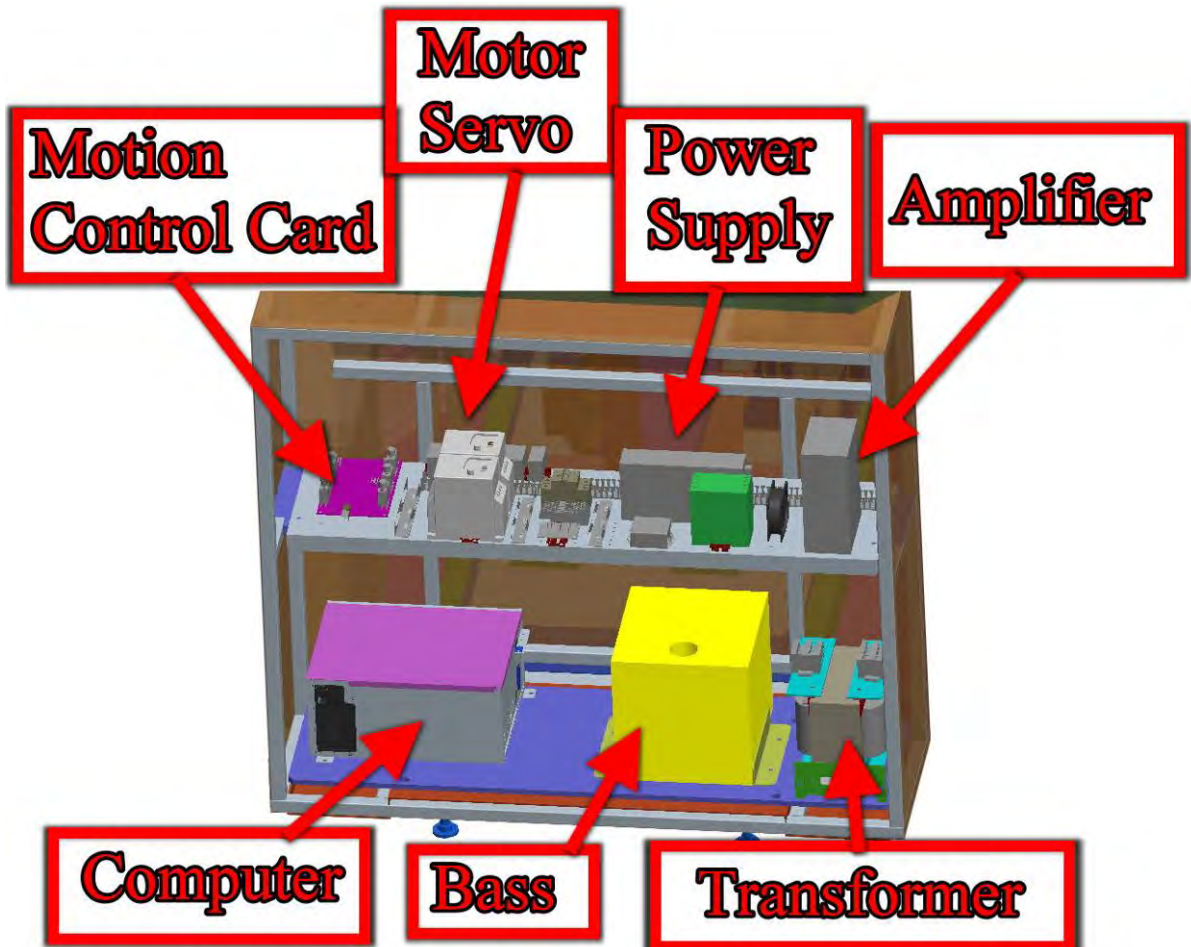

Figure 5-4 Cabinet electronic components



InJoy Motion Corp.

STREET RACING STARS MDX Service Manual

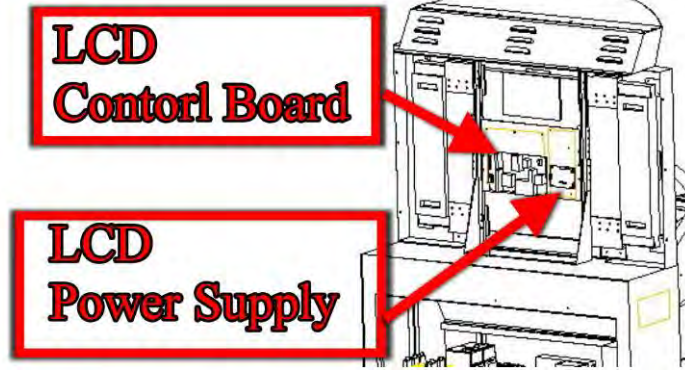

Figure 5-5 LCD electronic devices

5.3 COCKPIT ELECTRONIC COMPONENTS

Figure 5-6 ~ Figure 5-7 are the cockpit electronic components.

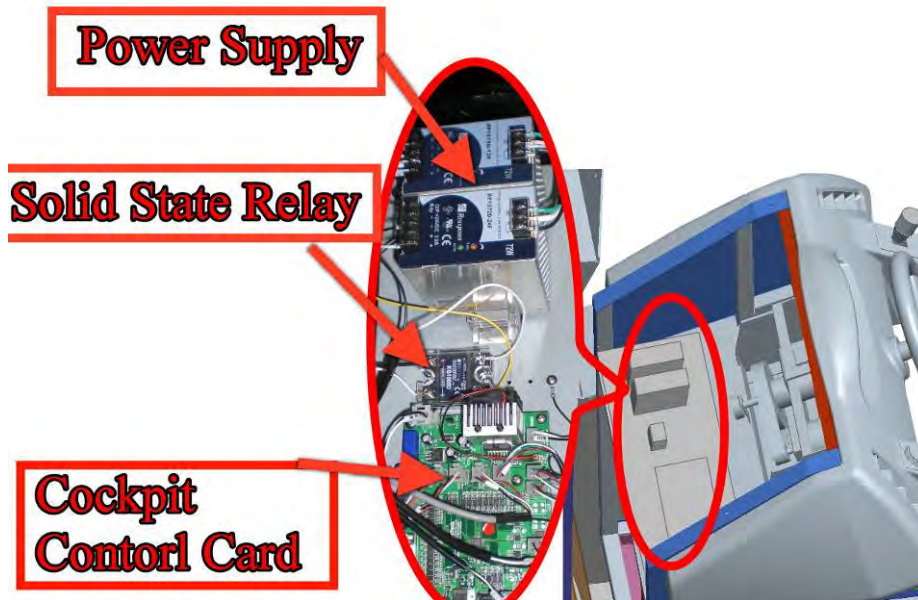

Figure 5-6 Cockpit electronic components-1

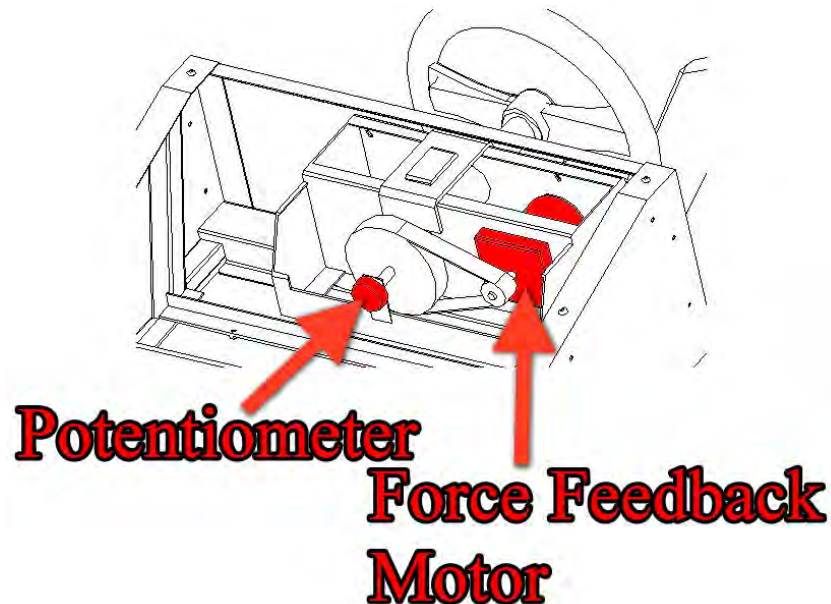

Figure 5-7 Cockpit electronic components-2



Injoy Motion Corp.

STREET RACING STARS MDX Service Manual

5.4 MAINTENANCE

Figure 5-8 shows the chassis of the STREET RACING STARS MDX, also known as the “Rotation Point” which needs to be lubricated every half-year.

“Rotation Point” is the rotation axis. When the motion starts up, the rotation axis will produce friction, and need lubrication semi-annually.

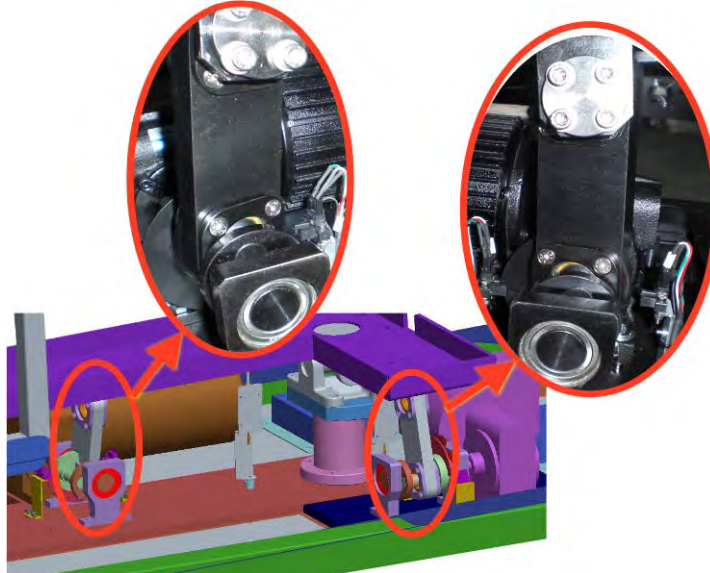
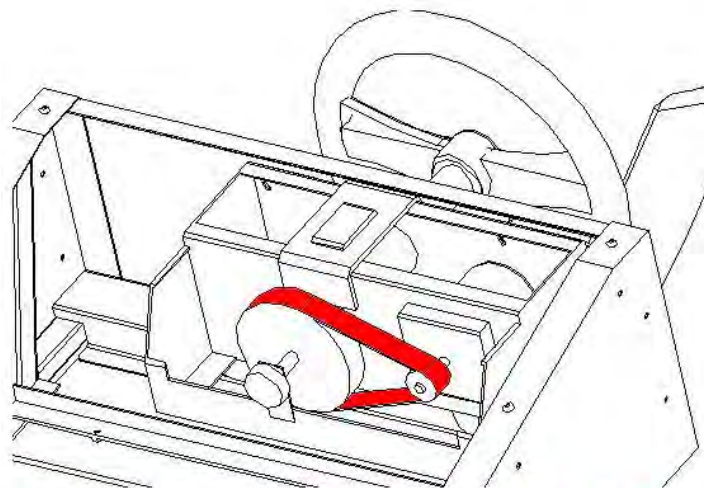

Figure 5-8 Rotation point

Figure 5-9 shows the transmission belt of the force feedback. It needs to check the status every half-year. If the force feedback decreases, please check the belt.

When the game starts, it will simulate the real steering wheel.



Transmission Belt

Figure 5-9 Transmission belts



Injoy Motion Corp.

STREET RACING STARS MDX Service Manual

6. TROUBLE SHOOTING

After Unit Power on, the system will follow these steps to start up.

Step	Symptom
1	Computer boot-up, steering wheel rotates to left limit, and rotate to right limit.
2	After 40 seconds, base starts “Homing (base starts rotating and then returns to the center position)”.
3	When system finishes Homing, screen will show “Loading...”
4	After Loading is finished, screen will display animation video

1. Power on fail

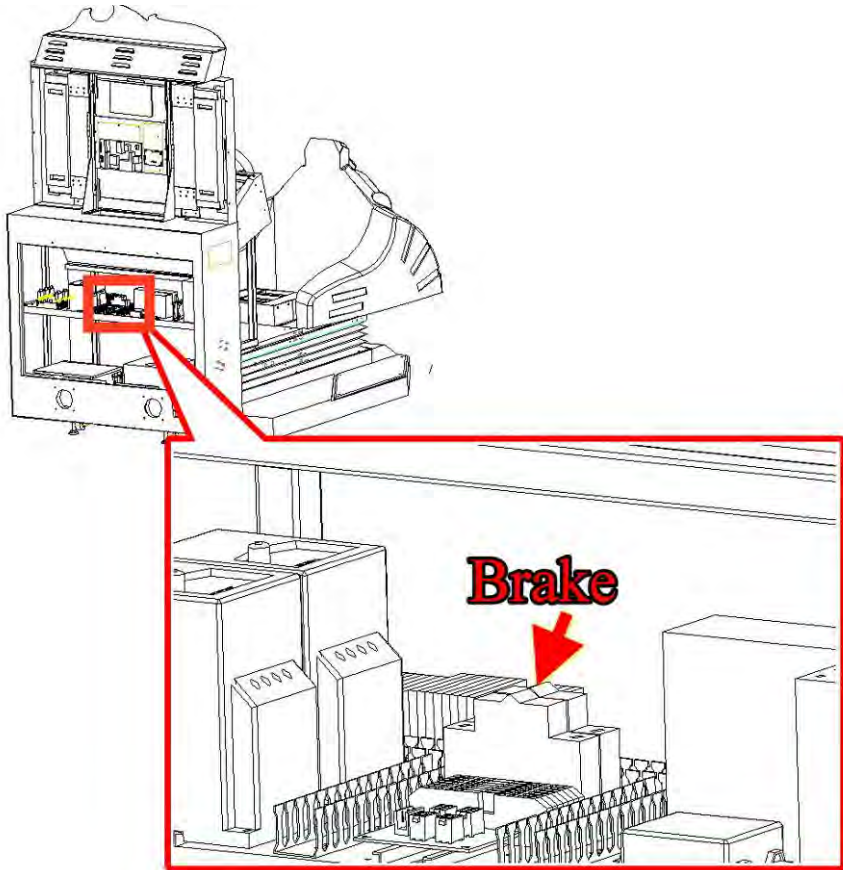
Step	Trouble shooting Guide
1	Please check the Power Source if 220V AC or not?
2	<p>Please unload the “footrest cover” of the base, and check the power breaker. If the breaker is OFF, please turn it to ON.</p> 
3	If the Power Source has 220V AC, and the breaker didn't OFF but the unit is still without Power, Please check if the power wire break off or not?



InJoy Motion Corp.

STREET RACING STARS MDX Service Manual

2. After Power ON, PC boot up, but base not homing after 40 seconds.

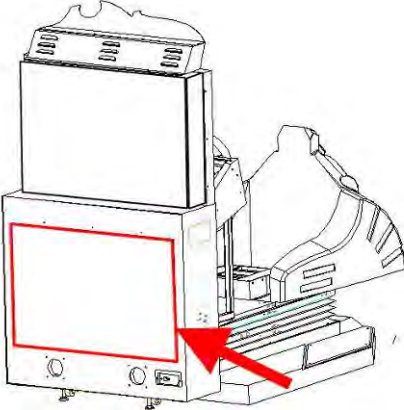
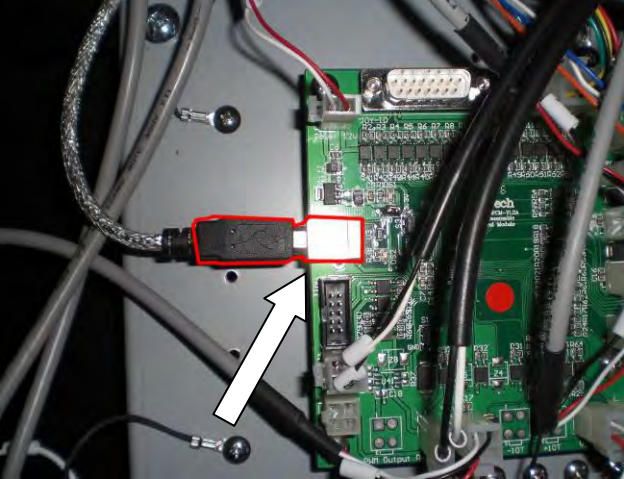
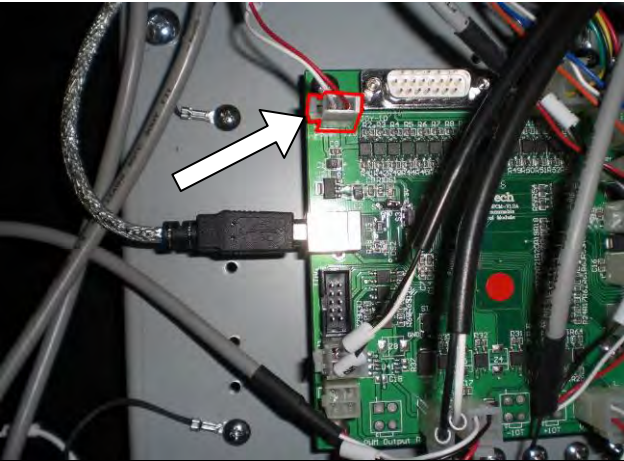
Step	Trouble shooting Guide
1	<p>Please unload the “back cover” of the Cabinet (please don’t power OFF), and check the motion control card.</p> 
2	<p>If the control card doesn’t have the green light, please check the USB connector.</p> 
3	<p>If the control card doesn’t have the red light, please check the input power connector.</p> 
4	<p>If the problem persists, please contact our Tech Support at: support@imon.com.tw</p>



InJoy Motion Corp.

STREET RACING STARS MDX Service Manual

3. Control interface no respond

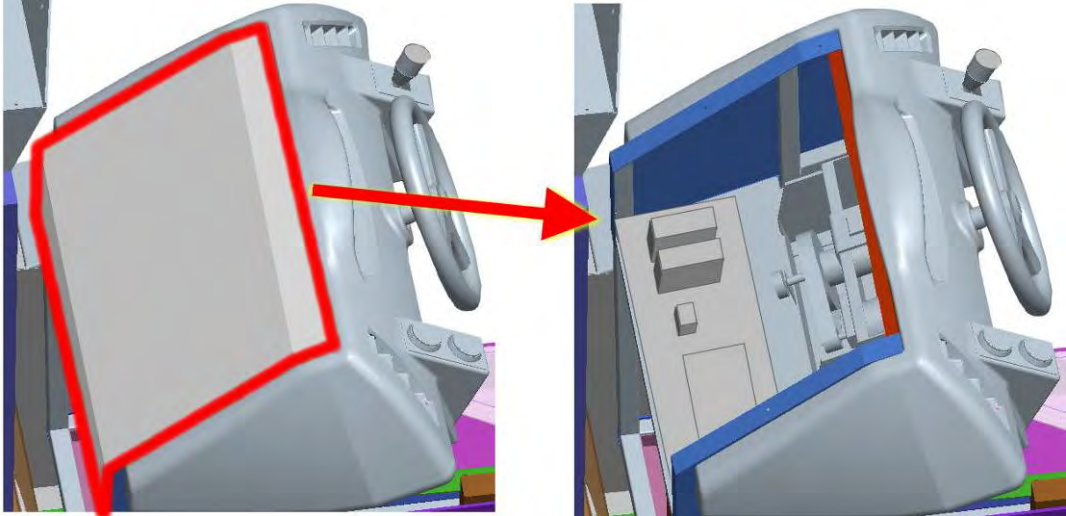
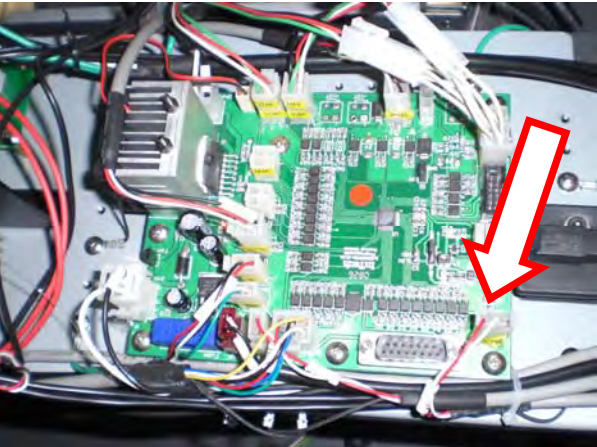
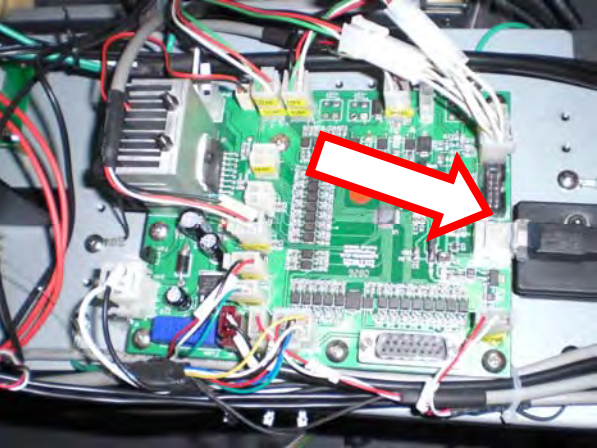
Step	Trouble shooting Guide
1	<p>Please unload the back cover of the LCD (Please don't power off the game)</p> 
2	<p>Please check the cockpit control board if it has Red light or not? If not, please check the wire and the connectors. If broken or damaged, replace it with new (parts to be provided by INJOY). If found ok, reconnect the wire connectors located on the control board and computer power supply.</p> 
3	<p>Please check the cockpit control board if it has Green light or not? If not, please check the USB connector or reconnect the wire connectors located on the computer USB port.</p>  <p>If the problem persist, please replace a new USB wire (length:3M)</p>



Injoy Motion Corp.

STREET RACING STARS MDX Service Manual

4	<p>If the problem persists, please make sure no other game shares this power source.</p> <table border="1"><tr><td data-bbox="352 230 1458 421"><p>1. AC Power Wire Diameter must be greater than 2.0mm</p><p>2. Earth connect must be indeed</p><p>3. No other appliance or game should share this power source on this circuit, otherwise <i>STREET RACING STARS MDX</i> will break down.</p></td></tr></table>	<p>1. AC Power Wire Diameter must be greater than 2.0mm</p> <p>2. Earth connect must be indeed</p> <p>3. No other appliance or game should share this power source on this circuit, otherwise <i>STREET RACING STARS MDX</i> will break down.</p>
<p>1. AC Power Wire Diameter must be greater than 2.0mm</p> <p>2. Earth connect must be indeed</p> <p>3. No other appliance or game should share this power source on this circuit, otherwise <i>STREET RACING STARS MDX</i> will break down.</p>		
5	<p>Please contact our Tech Support at: support@imon.com.tw, if the problem persists.</p>	