

HAMMERHEAD™



OWNERS AND SERVICE MANUAL INNOVATIVE CONCEPTS IN ENTERTAINMENT INC.



TABLE OF CONTENTS

INTRODUCTION.....	PAGE 3
GAME FEATURES GAME PLAY	
INSTALLATION.....	PAGE 4
BEFORE YOU BEGIN INSTALLATION	
PROGRAMMING OPTIONS.....	PAGE 5 & 6
INTRODUCTION USING THE PROGRAMMING OPTIONS	
MAINTENANCE.....	PAGE 7
QUICK TROUBLESHOOTING.....	PAGE 8
GAME REPAIR.....	PAGE 9 - 11
OPERATIONAL BACKGROUND TROUBLESHOOTING PHILOSOPHY MECHANICAL REPAIR	
PARTS LISTINGS.....	PAGE 12
SCHEMATICS.....	PAGE 13 - 15
WIRING DIAGRAMS.....	PAGE 16 - 28
HAMMER HEAD ASSEMBLY.....	PAGE 29
WARRANTY INFORMATION.....	PAGE 30

INTRODUCTION

GAME FEATURES

Thank you for purchasing the new Hammerhead™ game from I.C.E. This new “WACKY” game utilizes all the proven technology of it’s predecessor Smack-n-Alien. ICE has taken out the cost but not the quality, giving the customer a fresh look with full reliability.

Game cabinetry is stylish, yet bright. The game has been designed to be either a back-to-back centerpiece or a wall unit that will enhance the look of any location. Thick 16 gauge metal panels and marine grade water resistant plywood make the game extremely durable. The boat bow is made of a special high impact styrene that is easy to maintain.

The distortion printed marquee is made of .187 PETG. This is back printed, which will prevent the customer from damaging the printing. The PETG is more durable than acrylic and therefore will withstand impact better.

Electronics and sounds are the state of the art in digital technology. Robust design ensures a long trouble free life for your game. The game is very flexible with its programming options to allow it to be tailored to most locations easily.

GAME PLAY

The object of the game is to hit as many sharks as possible in the time allowed. (Note: the player must try to hit the sharks that are in the up position to score points) The player does not get penalized for missing a shark. The high score for the day will be displayed for all new players to try and match.

(NOTE: There is a bonus shark, the shark that pops up before game play starts. If a player hits that on he will be awarded one extra point.)

INSTALLATION

BEFORE YOU BEGIN

WARNING: WHEN INSTALLING THIS GAME, A GROUNDED A.C. RECEPTACLE MUST BE USED. FAILURE TO DO SO COULD RESULT IN INJURY TO YOURSELF OR OTHERS. FAILURE TO USE A GROUNDED RECEPTACLE COULD ALSO CAUSE IMPROPER GAME OPERATION, OR DAMAGE TO THE ELECTRONICS

DO NOT DEFEAT OR REMOVE THE GROUNDING PRONG ON THE POWER CORD FOR THE SAME REASON AS GIVEN ABOVE. USING AN IMPROPERLY GROUNDED GAME COULD VOID YOUR WARRANTY.

HAVE A QUALIFIED ELECTRICIAN CHECK YOU'RE A.C. RECEPTACLE TO BE SURE THE GROUND IS FUNCTIONING PROPERLY.

CAUTION: CHECK THAT THE A.C. VOLTAGE RATING ON THE BACK OF THE GAME MATCHES THE A.C. VOLTAGE OF YOUR LOCATION.

THE POWER SUPPLY IS NOT VOLTAGE ADJUSTABLE.

TO OPERATE THE GAME AT VOLTAGES OTHER THAN THOSE IT WAS DESIGNED FOR, PLEASE CONTACT OUR SERVICE DEPARTMENT FOR VOLTAGE CONVERSION INFORMATION.

Plug the game into the A.C. outlet and turn on power to the game. The switch for the game is located on a power module on the outside rear of the game.

It is now time to program your game.....

TOOLS NEEDED

The game normally comes fully assembled and ready for use.

If however, you need to disassemble or reassemble the marquee to the game for any reason, all that is needed is a 5/32 security Allen wrench.

INSTALLATION

The game comes ready to play with just a few simple things to keep in mind.

1. When installing the game, be sure you use a grounded A.C. outlet. If necessary, have it checked to be sure the ground is good.

THIS GAME IS DESIGNED TO DISSIPATE STATIC ELECTRICITY THROUGH THE GROUNDING PLANE OF THE GAME. IF THE A.C. GROUND DOES NOT WORK, THE GAME COULD DISCHARGE STATIC ELECTRICITY THROUGH THE GAME CIRCUITRY, WHICH COULD CAUSE DAMAGE.

2. Make sure the game is level after installation. It is necessary to make sure the game is level so the game will work properly.
3. Place the game into its final location and use the adjusting feet to level the game.

PROGRAMMING

INTRODUCTION

The Hammerhead™ game is extremely flexible from a programming standpoint. This allows the customer to “fine tune” the game to his or her exact needs.

This section will describe in detail each of the programming options and how they work.

PLEASE READ THIS SECTION THOROUGHLY BEFORE CALLING OUR SERVICE DEPARTMENT. MOST QUESTIONS REGARDING SET-UP AND OPERATION WILL BE FULLY EXPLAINED HERE.

HOW TO USE THE PROGRAMMING OPTIONS

PROGRAMMING BUTTON – Use this button to enter and exit the programming mode. Press this button once to enter the mode, and once again to exit the mode.

SELECT BUTTON – Use this button to scroll through and “step” through the various options.

ADVANCE BUTTON – Use this button to “change” the value of a particular option.

TICKET RESET BUTTON - Use this button to “reset” ticket counter.

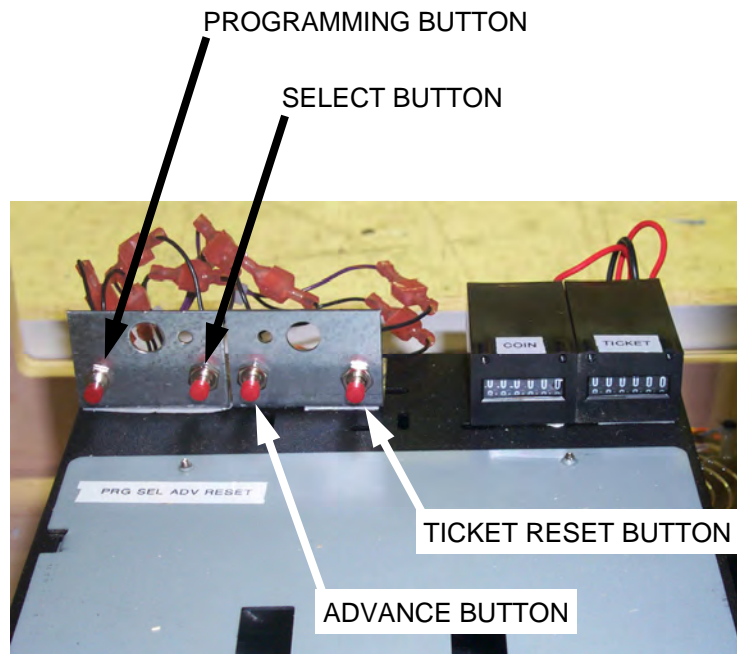

PROGRAMMING

<u>OPTION</u>	<u>DEFAULT</u>	<u>MIN / MAX</u>		<u>DEFINITION</u>
0	7	00	10	Volume adjustment
1	2	01	09	coins per credit switch 1
2	1	00	09	# of coin 1's per credit switch 2
3	20	10	99	number of seconds per game
4	2	00	06	difficulty (lower = easier)
5	2	00	09	tickets just for playing
6	5	01	10	hits per tickets
7	25	00	99	ticket cap per game
8	5	00	99	minutes between attract mode
9	3	01	03	attract mode type
10	00	00	01	factory reset

NOTE: After the factory reset has been selected, the programming button must be pressed twice to exit.

MAINTENANCE

GENERAL MAINTENANCE

This game has been designed to be as trouble and maintenance free as possible.

With this in mind the only basics are to keep the game clean. Below are the main areas to take care of with specific directions.

MARQUEE

The MARQUEE should be cleaned with a soapy water solution if covered with water-based dirt such as food products. After cleaning with soapy water, polish with a commercial plastic polish or a spray furniture polish. These have lubricating oils that condition the plastic and keep it shiny and clear looking. Never use regular glass cleaners as the ammonia in them actually damages the plastic and dulls it.

Any deep scratches can be reduced or eliminated with a scratch removing polish and buffing wheel.

CABINET

The cabinet plastic and decals can be cleaned with soapy water or spray furniture polish. DO NOT use any alcohol or petroleum based cleaners as they could damage the plastic or printed parts.

COIN MECHANISMS

The coin mechanisms should be cleaned periodically, as they will accumulate dirt, which will cause the coins to stick.

Remove the coin mech and clean them in a dish detergent solution and a stiff brush. Dry thoroughly and re-install.

TICKET DISPENSERS

The biggest problem ticket dispensers have is ticket dust blocking the optical detectors. It is a good idea to occasionally use compressed air to remove the dust from the dispensers.

SHARK HEAD

The sharks should be cleaned with a soapy water solution. Be sure to wring the sponge out before cleaning. Excess water may drip onto coil bed assembly and cause permanent damage.

LUBRICATION

We do not recommend the use of any lubrication anywhere on the game.

The only moving parts on the game are the sharks. If you notice any sticking or binding of the sharks check the following.

- Dirt on the solenoid shafts – Remove the solenoid shafts, clean with isopropyl alcohol. Finish wiping clean with a good grade of spray polish only.
- Wear – If excessive solenoid body wear is noted, replace the solenoid coil.

QUICK TROUBLESHOOTING

GAME WILL NOT TAKE OR ADD MONEY CORRECTLY

- Micro switch not working or returning properly. Check and repair or replace as necessary.
- Bad Harnessing or connector. Check w/ohm meter and repair as necessary.
- Game programming set incorrectly. Check programming option and re-program if necessary.
- Bad Main P.C. Board. Check and repair or replace as necessary.

SHARKS WILL NOT POP UP DURING GAME PLAY

- Opto Sensor is not working properly. Test and replace as necessary.
- Reflective foil is not properly in place. Reapply foil correctly.
- Bad harnessing or connector. Check w/ohm meter and repair as necessary.
- Bad Main P.C. Board. Check and repair or replace as necessary.

GAME HAS NO SOUND

- Bad speaker. Check w/ohm meter for 4 or 8-ohm load. If not within this range, replace.
- Volume level set incorrectly. Check volume level in programming, and adjust if necessary.
- Bad Harnessing or connector. Check w/ohm meter and repair as necessary.
- Bad Main P.C. Board. Check and repair or replace as necessary

TICKET DISPENSER DOES NOT WORK OR WORKS IMPROPERLY

- Bad ticket dispenser. Repair or replace as necessary.
- Bad harnessing or connector. Check w/ohm meter and repair as necessary.
- Bad Main P.C. Board. Check and repair or replace as necessary.
- Game out of tickets. Add tickets
- Optical sensor on ticket dispenser dirty. Remove paper fuzz and debris with a soft brush.

NO FLORESCENT LIGHTING

- Bulb burned out. Replace bulb.
- Electronic ballast bad. Replace ballast.
- Harness bad or harness unplugged. Check w/ohm meter and plug in, repair or replace as necessary.
- No A.C. power to the game or Main fuse bad. Check fuse and A.C. power.

TICKETS OR HIGH SCORE DISPLAY Don't WORK PROPERLY

- Bad Display P.C. Board. Repair or replace Display board
- Bad Main P.C. Board. Repair or replace Main board.
- Bad display harnessing. Repair as necessary.

CAN'T ENTER OR EXIT PROGRAMMING OR OTHER ADJUSTMENT MODES

- Bad programming or adjustment buttons. Replace buttons. Check harnessing.
- Bad Main P.C. Board. Repair or replace Main board.

GAME REPAIR

WARNING: ALWAYS REMOVE POWER TO THE GAME BEFORE ATTEMPTING ANY SERVICE, UNLESS NEEDED FOR SPECIFIC TESTING.

FAILURE TO OBSERVE THIS PRECAUTION COULD RESULT IN SERIOUS INJURY TO YOURSELF OR OTHERS.

OPERATIONAL BACKGROUND

The HAMMERHEAD™ game has been manufactured with modular design in mind. Almost everything in the game can be EASILY removed for servicing. This makes it much easier for the repairman as he / she can work in a quieter less distracting environment away from the Game Room floor. The game relies on 1 coil bed assembly which can be removed from the game very easily.

Coin and low ticket sensing are done with conventional micro switches. In all areas of critical importance, optical sensors were developed specifically, and optimized for their particular application.

All P.C. Boards are made of premium quality board material and use time proven components to assure you of the most reliable designs possible.

We have put forth our best efforts and tested this game extensively to assure the best possible performance under the widest variety of operating conditions. We are ALWAYS however interested in our customers input for product improvement. If you have any questions or comments please feel free to contact our service department.

I.C.E. SERVICE DEPARTMENT

716-759-0360

NORMAL BUSINESS HOURS ARE:

MONDAY – FRIDAY, 9:00 AM TO 6:00 PM EST

TROUBLESHOOTING PHILOSOPHY

To find problems with the game, always first check what should be obvious. See that the game is plugged in, and that all of the fuses on the game are good. This includes the fuse that is located INSIDE the power module.

Next, check to see that all of the connectors are firmly seated and that none of the wires have been pulled out of them.

When trying to find out if specific components are bad or not. This will help you to know if you have a problem with a specific component, or maybe a problem with either the wiring or the Main P.C. Board.

Use extreme caution when using probes or voltmeters if the game is powered up. If doing continuity checks, it is important to disconnect the harnessing at both ends, as attached they may yield erroneous results.

If a P.C. Board is suspected as the cause of a problem, check to see that all of the components on the board are firmly attached. Pay special attention to any socketed devices.

If light bulbs are suspected, swap them with a bulb that is known to work to narrow the problem down to either a bulb or P.C. Board.

GAME REPAIR

REPLACEMENT & REPAIR

COIL BED SERVICING

To remove the coil bed:

1. Remove the 4 bolts that hold the boat bow on to the cabinet. The bolts are located on the underside of the playfield, on the left & right sides of the game.

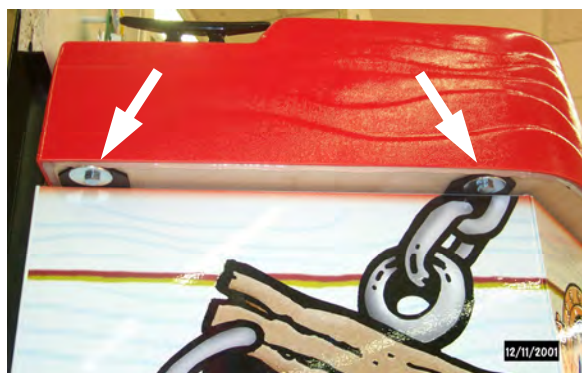

2. Remove the 6 bolts holding the coil bed in position as shown in the photo below.



3. Unplug the multi pin connector by twisting off.



COIL BED PARTS REPLACEMENT

Service the coil bed as follows:

1. Remove all the shark heads from the coil bed. To remove sharks, turn the coil bed over so that the coil bed is resting on the shark heads. Remove the Allen head screw from the shaft. Cut the wire tie and remove the locking pin. Pull the shark heads through the coil bed.

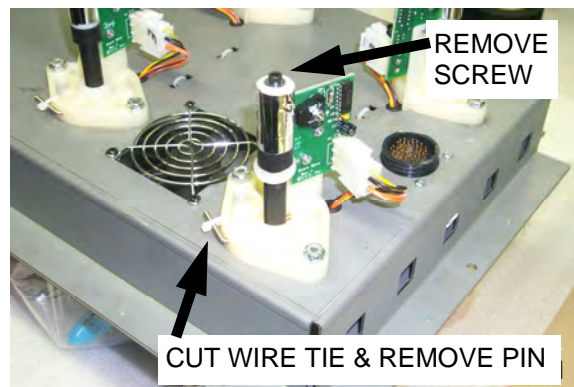

2. Unplug the Sensor PCB Assembly. Remove the two Nylok nuts holding the coil cap.

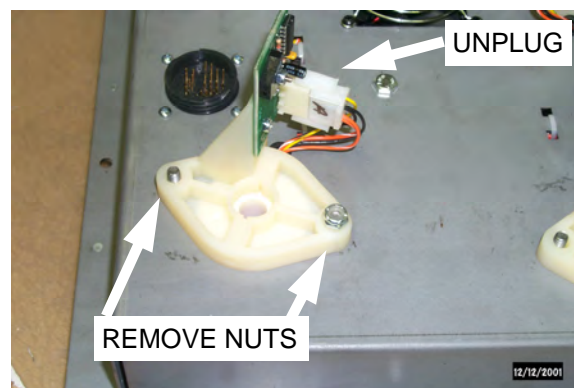

4. Disconnect the wires to the coil & remove.



5. Assemble in reverse order.

GAME REPAIR

MARQUEE BULB / DISPLAY BOARD SERVICE

To replace a light bulb:

1. Remove the square drive screws on the rear of the marquee, that attach the lamp mounting panels. Start with the side that looks like the light is out.

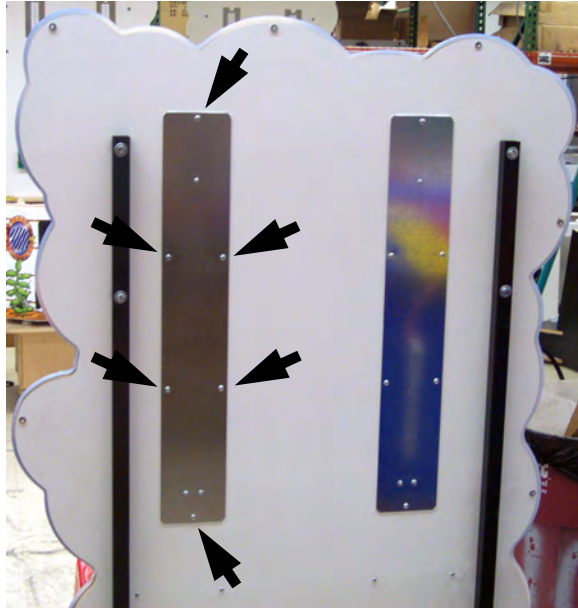

3. Using a Phillips screwdriver, remove the four screws that hold the board in place.

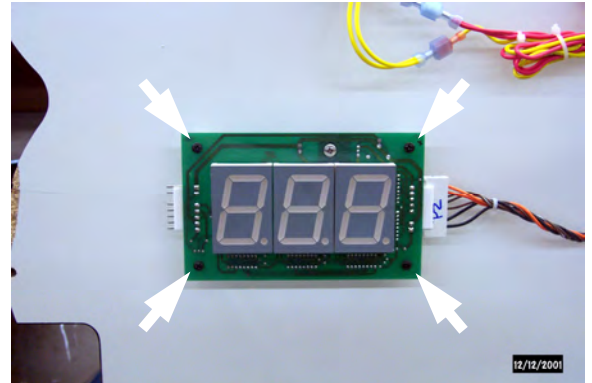

4. Repeat the previous steps to remove the second display.

IF YOU HAVE ANY QUESTIONS OR COMMENTS, PLEASE CONTACT OUR SERVICE DEPARTMENT AT:

**716-759-0360
MON. THRU FRI. 8AM-5PM EST**

Display Board follow the directions below:

1. **CAUTION:** Be sure that the power has been disconnected before attempting to unplug the Display Boards.
2. Remove the security Allen bolts around the perimeter of the marquee.



PARTS LISTING

Parts denoted with * indicate available as part of a specially discounted spares kit.

ELECTRONIC / ELECTRICAL

MECHANICAL PARTS

E00211	Low Ticket Micro Switch
BW250X	PLL Bulb Socket Assembly
FP1004	Leg Leveler Mounting Bracket
HR1019	Leveler Foot
Ws1022	Ticket Bin Entropy Style
1026	Bracket, Low Ticket Switch Mounting
AR2007	Speaker, 6" x 9"
BW2017	PLL Bulb Retaining Clip
BW2018	PLL Bulb Support
2027	Fan, DC 12 Volt
5101X	Mech Holder Assembly
BW8284X	Workhorse 6 Ballast, (WH6-120-L)
8312*	Bulb, PL-L 40W/41/RS/IS Fluorescent
HH5005	Ticket Dispenser
WA4010	Mallet
WS4011B	Shark head only Blue
WS2011BX	Shark head w/base Blue
WS4011G	Shark head only Green
WS2011GX	Shark head w/base Green
WS4011O	Shark head only Orange
WS2011OX	Shark head w/base Orange
WS4011PU	Shark head only Purple
WS2011PUX	Shark head w/base Purple
WS4011PI	Shark head only Pink
WS2011PIX	Shark head w/base Pink
WS4011Y	Shark head only Yellow
WS2011Y	Shark head w/base Yellow
175	Immonex Mech.
2289	Reset Button
CG2027	Power Cord 9'
2364	Coil Bed Fan
WA1054	Limiting Pin
WS7027X	Marquee Vacuum Form
WS3004	Boat Cleat
WS8444X	Jewel Light Assembly
WS2011X	Base Assembly
WS9001	Service Manual
WS2011SX	Full assembly of shark heads w/base
	Set of 6
WS3003X	Playfield assembly
WA3006	Shaft Cap
WSsharkkit	Shark + Mallet kit
WA3002	Spring cap
WA3003X	Coil Cap

WS2034X	Main PCB
WS2032X	Display Boards
2295	Fuse, MDQ6 (6 Amp Slo Blo)
2315	Fuse, MDQ3 (3 Amp Slo Blow
E20429	Flashing LED (Low Ticket)
MZ8284X	Ballast Workhorse 6
WA3001X	Coil
WS2002X	Transformer
WS2007X	Power mod
WS2039X	Shark opto
WSlightkit	Light + sensor kit
WSsparekit	Spare parts kit

DECALS AND GRAPHICS

WS7003	BOAT DECK DECAL
WS7005	FRONT DECAL
WS7112	RIGHT SIDE DECAL
WS7110	LEFT SIDE DECAL
WS7027	MARQUEE (BACK DROP)
WS7006	ICE LOGO

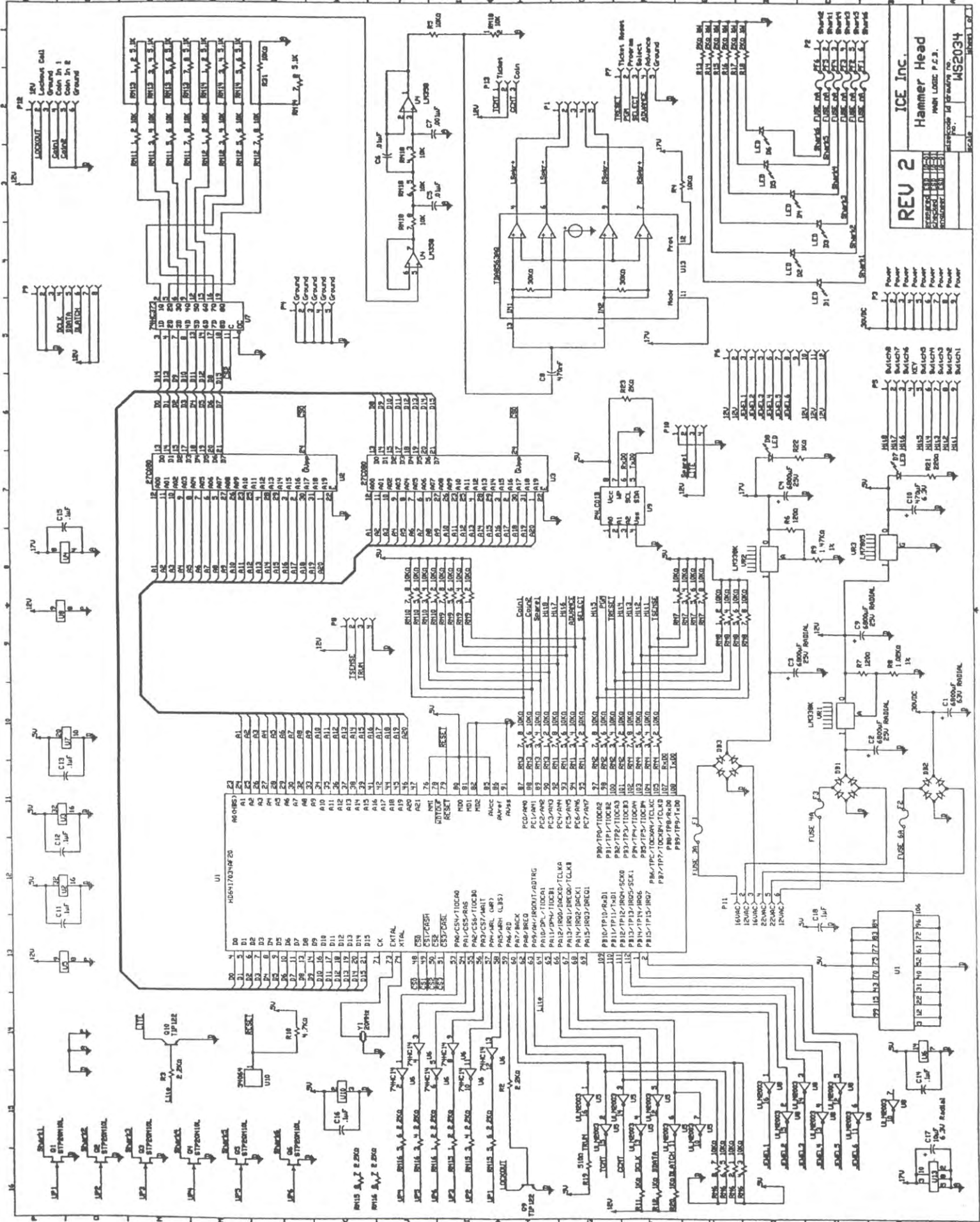

REV 2

ICE Inc.

Hammer Head

PLEASE DO NOT REPAIR OR
MODIFY THIS BOARD

MS2034

Sheet 1 of 2

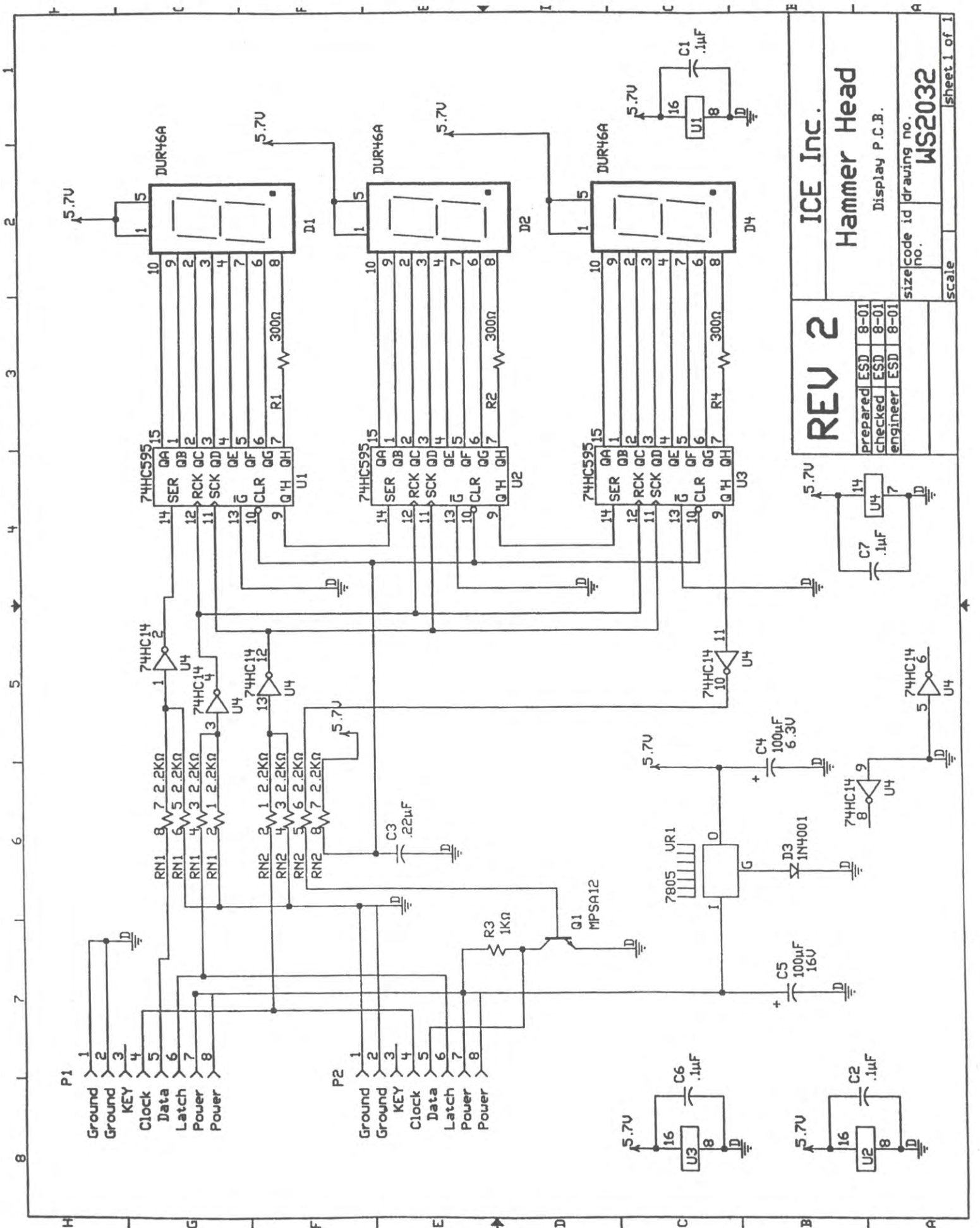

REV 2

Prepared	ESD 8-01
Checked	ESD 8-01
Engineer	ESD 8-01

ICE Inc.
Hammer Head
Display P.C.B.

size	Code id	drawing no.
scale		WS2032

Sheet 1 of 1

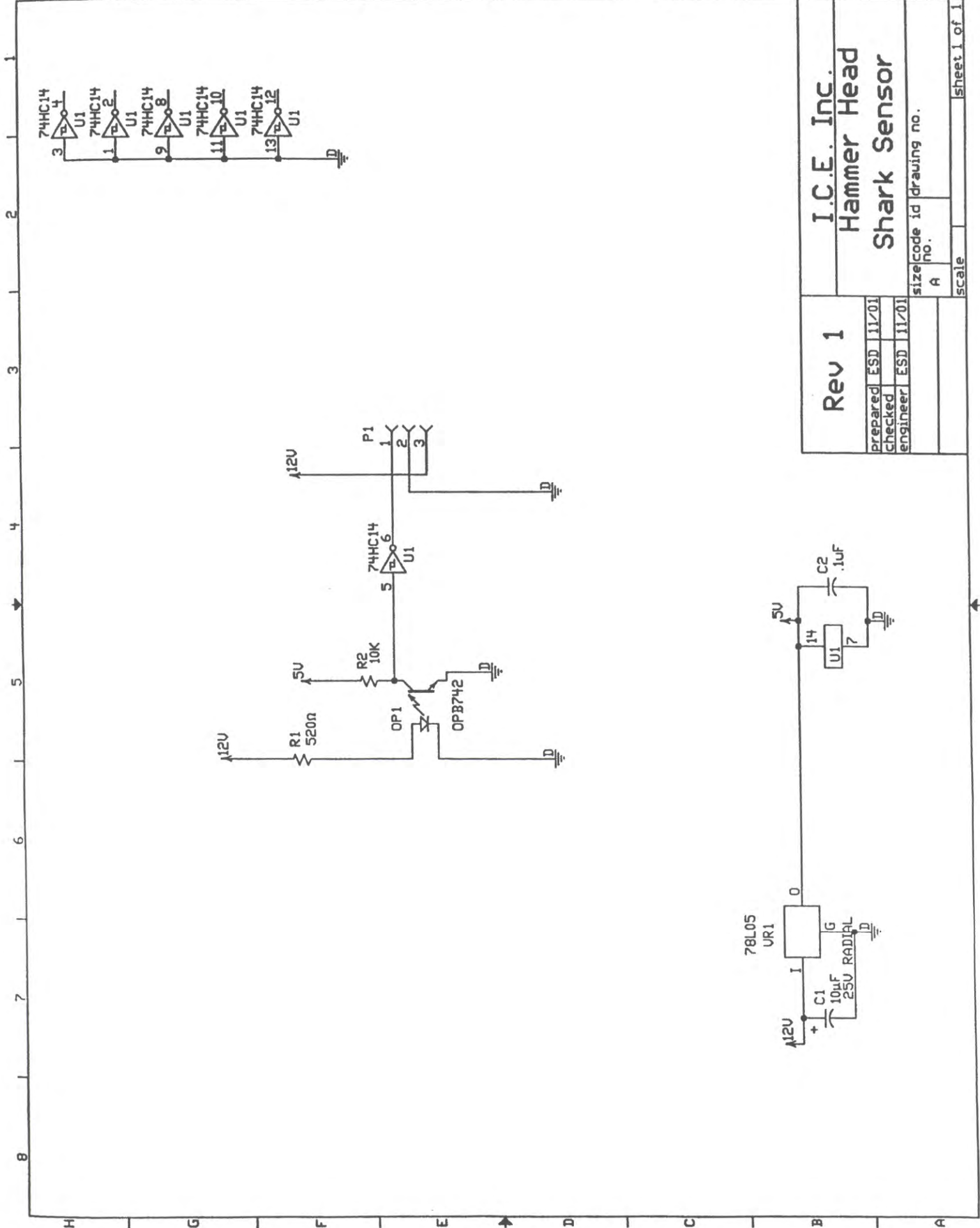

Rev 1

Prepared	ESD 11/01
Checked	
Engineer	ESD 11/01

I.C.E. Inc.	
Hammer Head	
Shark Sensor	
size	code id drawing no.
A	
scale	
Sheet 1 of 1	

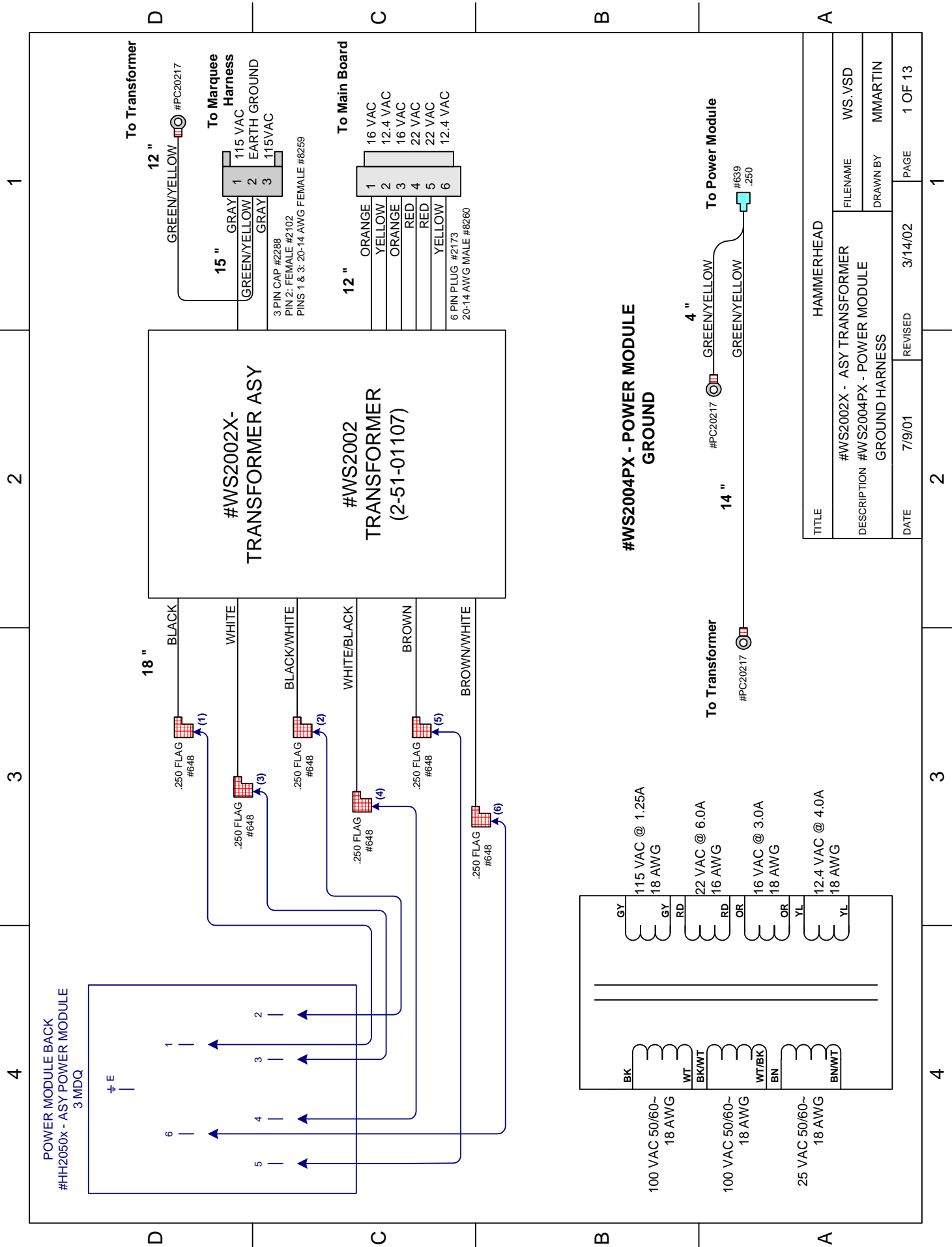

TITLE	HAMMERHEAD		FILENAME	WS.VSD
DESCRIPTION	#WS2002X - ASY TRANSFORMER	GROUND HARNESS		
DATE	7/9/01	REVISED	3/14/02	PAGE 1 OF 13

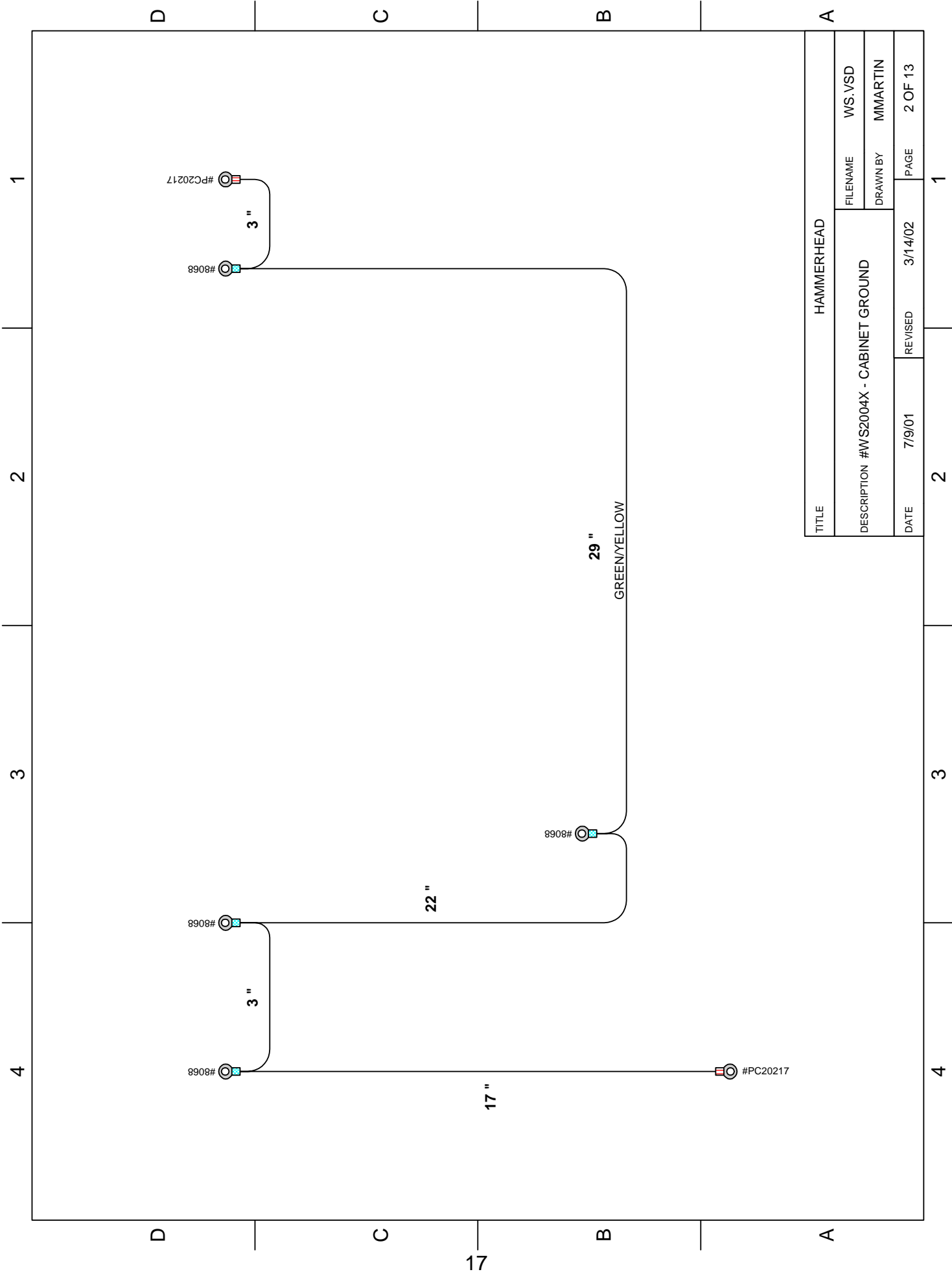

TITLE		HAMMERHEAD	
DESCRIPTION		FILENAME	WS.VSD
		DRAWN BY	MMARTIN
DATE	7/9/01	REVISED	3/14/02
		PAGE	2 OF 13

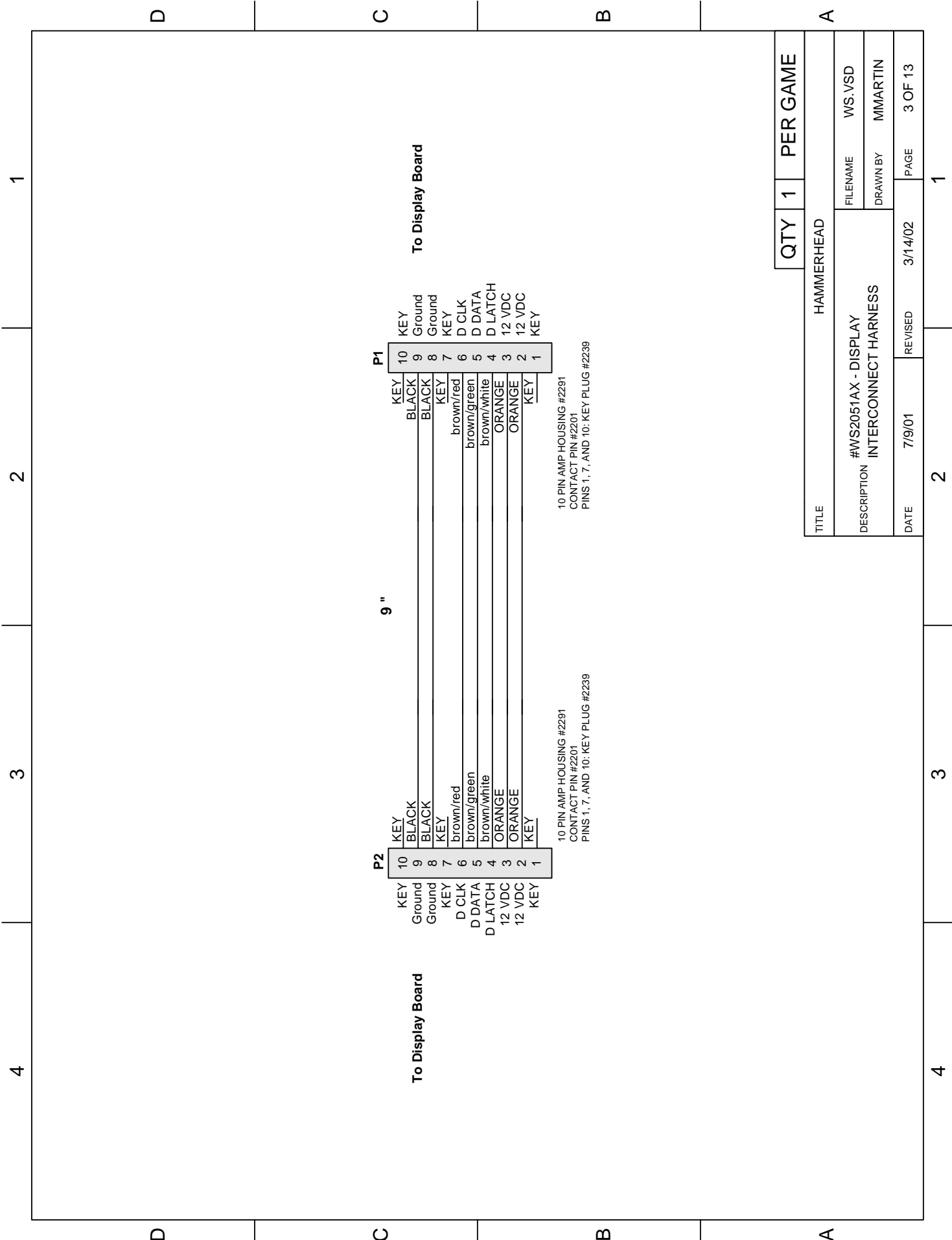

To Display Board

P1		P2	
10	KEY	10	KEY
9	Ground	9	BLACK
8	Ground	8	BLACK
7	KEY	7	KEY
6	brown/red	6	brown/red
5	brown/green	5	brown/green
4	brown/white	4	brown/white
3	ORANGE	3	ORANGE
2	ORANGE	2	ORANGE
1	KEY	1	KEY

10 PIN AMP HOUSING #2291
CONTACT PIN #2201
PINS 1, 7, AND 10: KEY PLUG #2239

10 PIN AMP HOUSING #2291
CONTACT PIN #2201
PINS 1, 7, AND 10: KEY PLUG #2239

9"

To Display Board

TITLE		HAMMERHEAD	
DESCRIPTION		FILENAME	WS.VSD
DATE		DRAWN BY	MMARTIN
DATE		REVISED	PAGE
7/9/01	3/14/02	3 OF 13	1

QTY	1	PER GAME
-----	---	----------

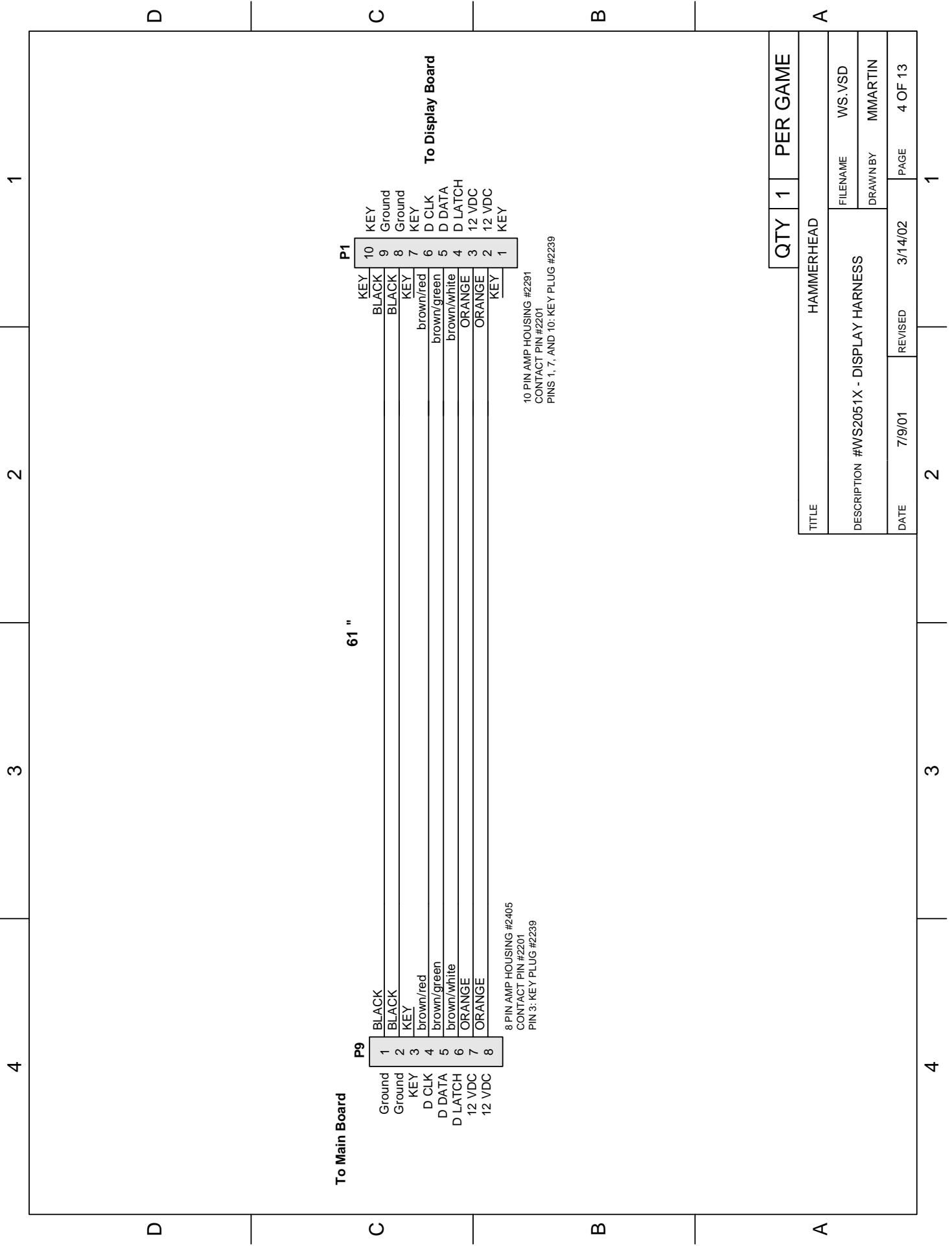

To Main Board

P9	
1	Ground
2	Ground
3	KEY
4	D CLK
5	D DATA
6	D LATCH
7	12 VDC
8	12 VDC

8 PIN AMP HOUSING #2405
CONTACT PIN #2201
PIN 3: KEY PLUG #2239

61 "

P1	
10	KEY
9	Ground
8	Ground
7	KEY
6	D CLK
5	D DATA
4	D LATCH
3	12 VDC
2	12 VDC
1	KEY

To Display Board

10 PIN AMP HOUSING #2291
CONTACT PIN #2201
PINS 1, 7, AND 10: KEY PLUG #2239

TITLE		HAMMERHEAD	
DESCRIPTION #WS2051X - DISPLAY HARNESS		FILENAME	WS.VSD
DATE		DRAWN BY	MMARTIN
7/9/01	REVISED	3/14/02	PAGE
2	1	4 OF 13	1

QTY 1 PER GAME

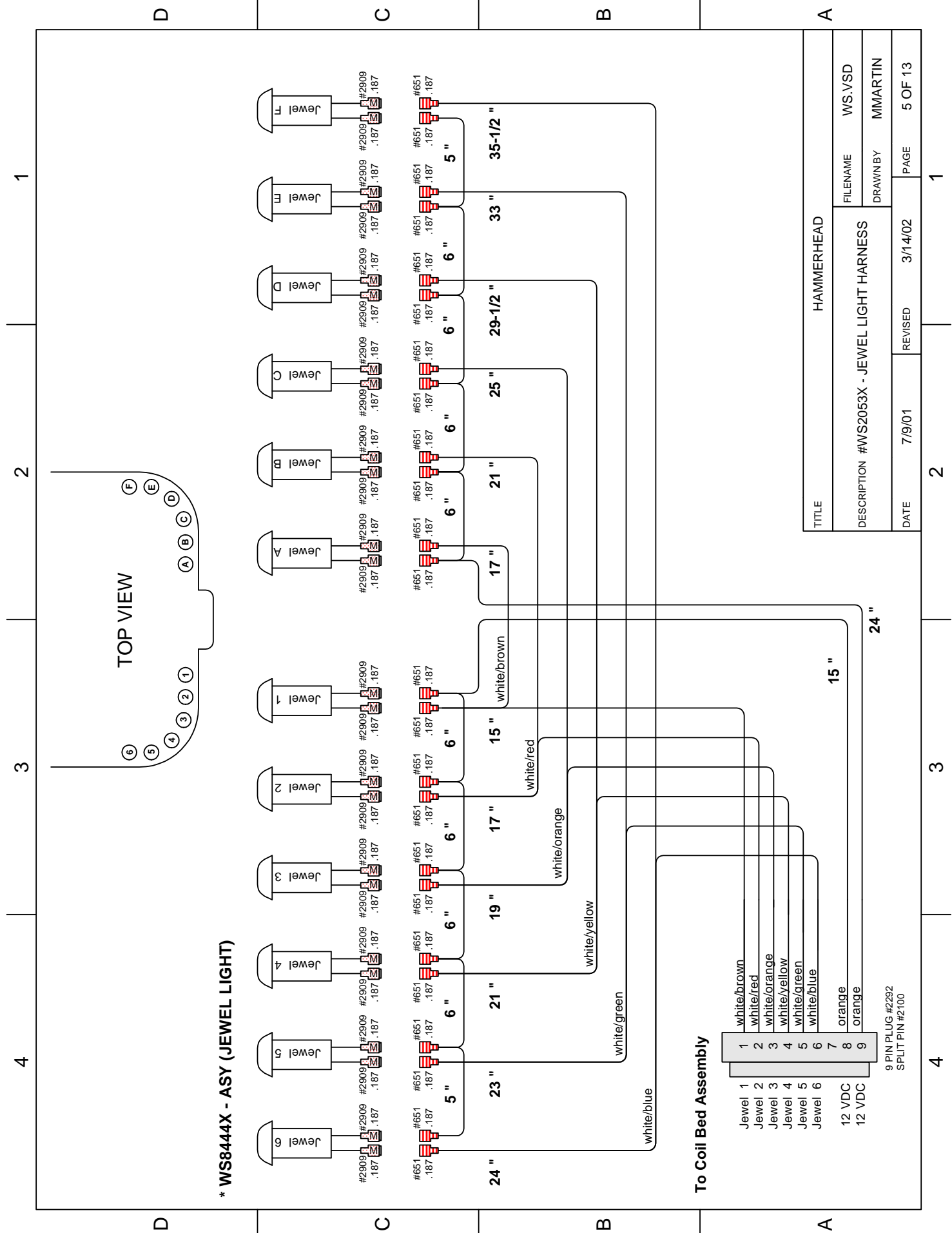

1
2
3
4

D C B A

To Transformer

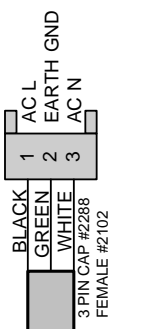

59 "

To Ballast Assembly

TITLE		HAMMERHEAD	
DESCRIPTION #WS2056X - MARQUEE HARNESS		FILENAME	WS.VSD
DATE 7/9/01		DRAWN BY	MMARTIN
REVISED 3/14/02		PAGE	6 OF 13

1
2
3
4

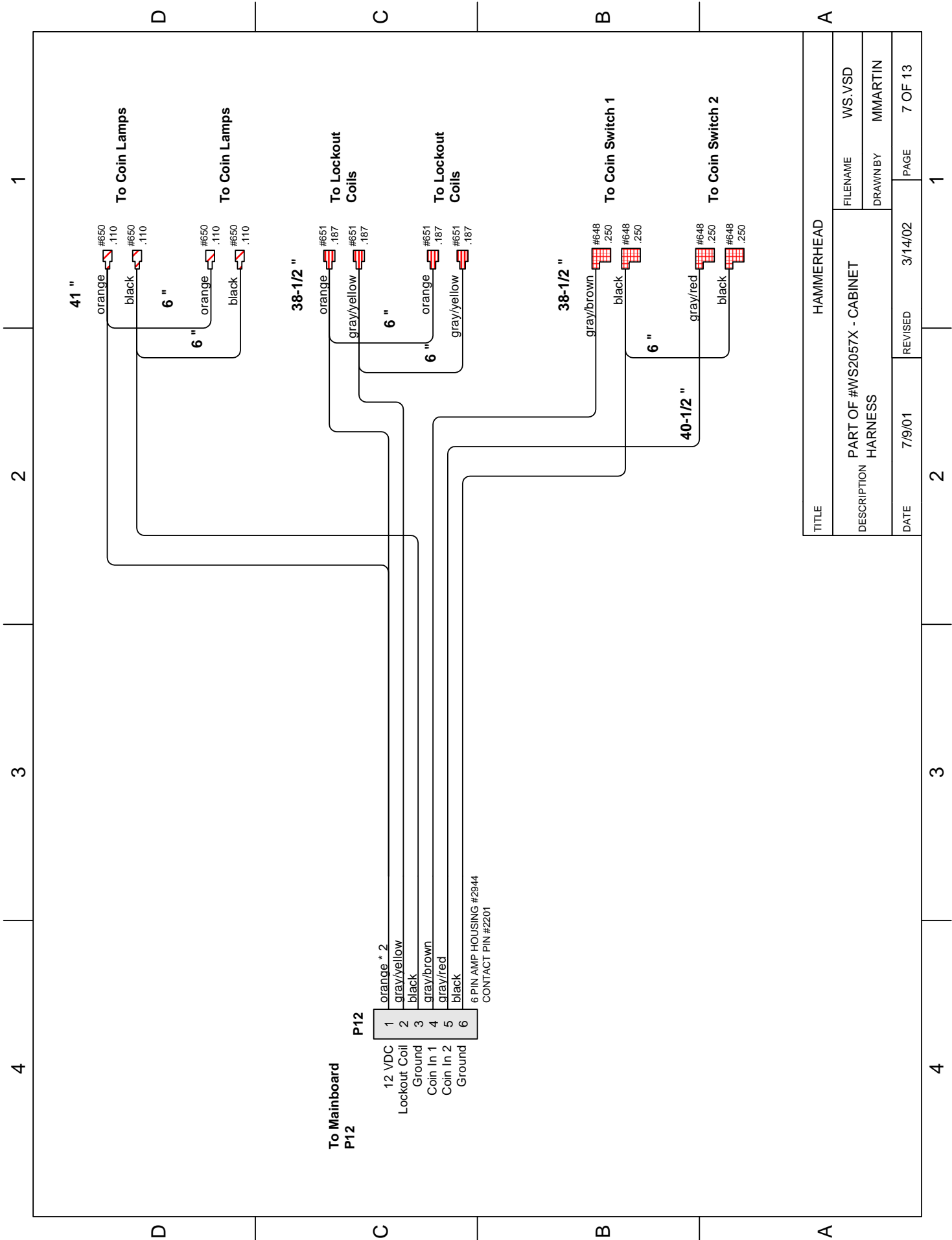

TITLE		HAMMERHEAD	
DESCRIPTION		PART OF #WS2057X - CABINET HARNESS	
FILENAME	WS.VSD	DATE	7/9/01
DRAWNBY	MMARTIN	REVISED	3/14/02
PAGE	7 OF 13	SECTION	2
1		3	
4		1	

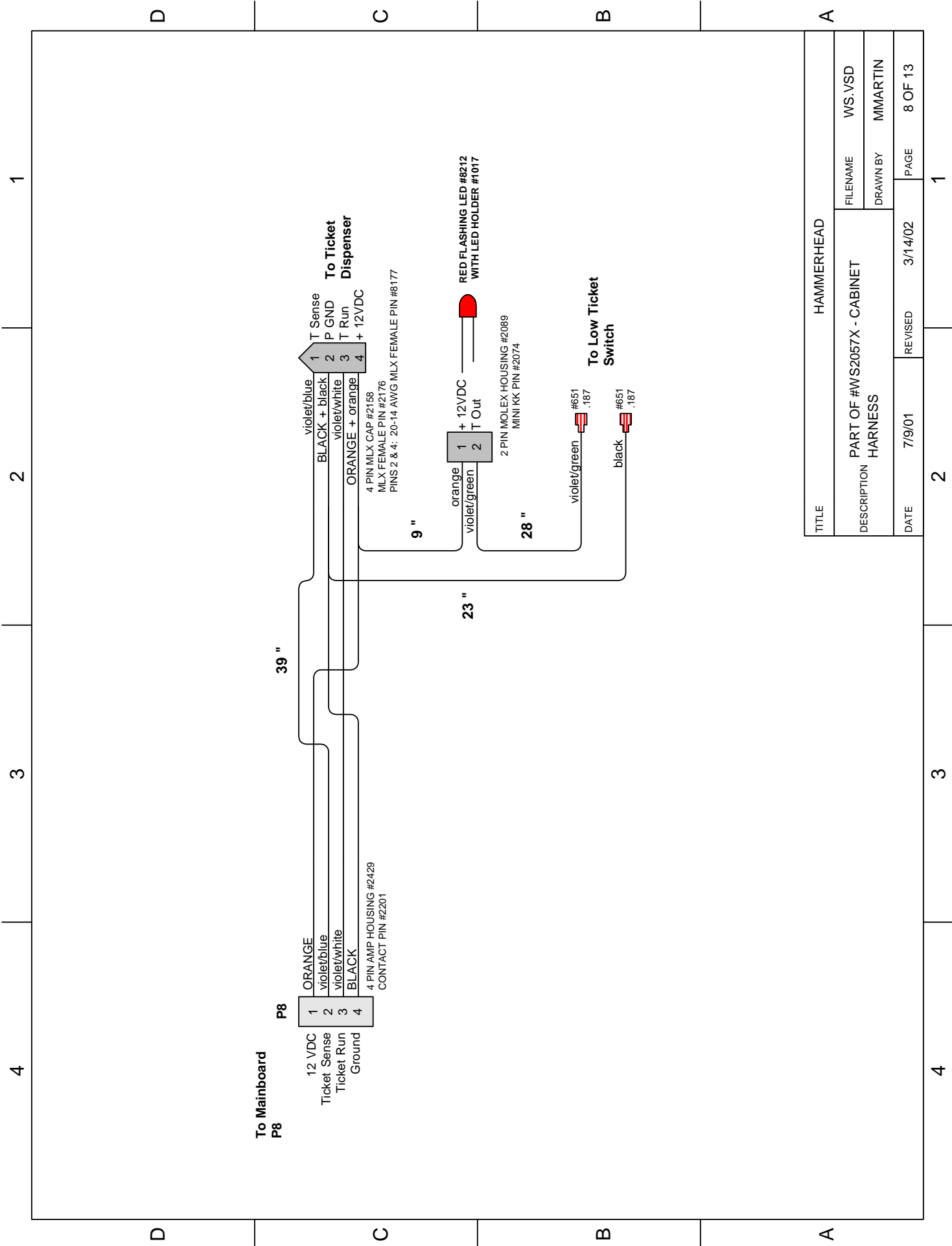

TITLE		HAMMERHEAD	
DESCRIPTION		FILENAME	WS.VSD
DATE		DRAWN BY	MMARTIN
7/9/01	REVISED	3/14/02	PAGE 8 OF 13

4 3 2 1

4 3 2 1

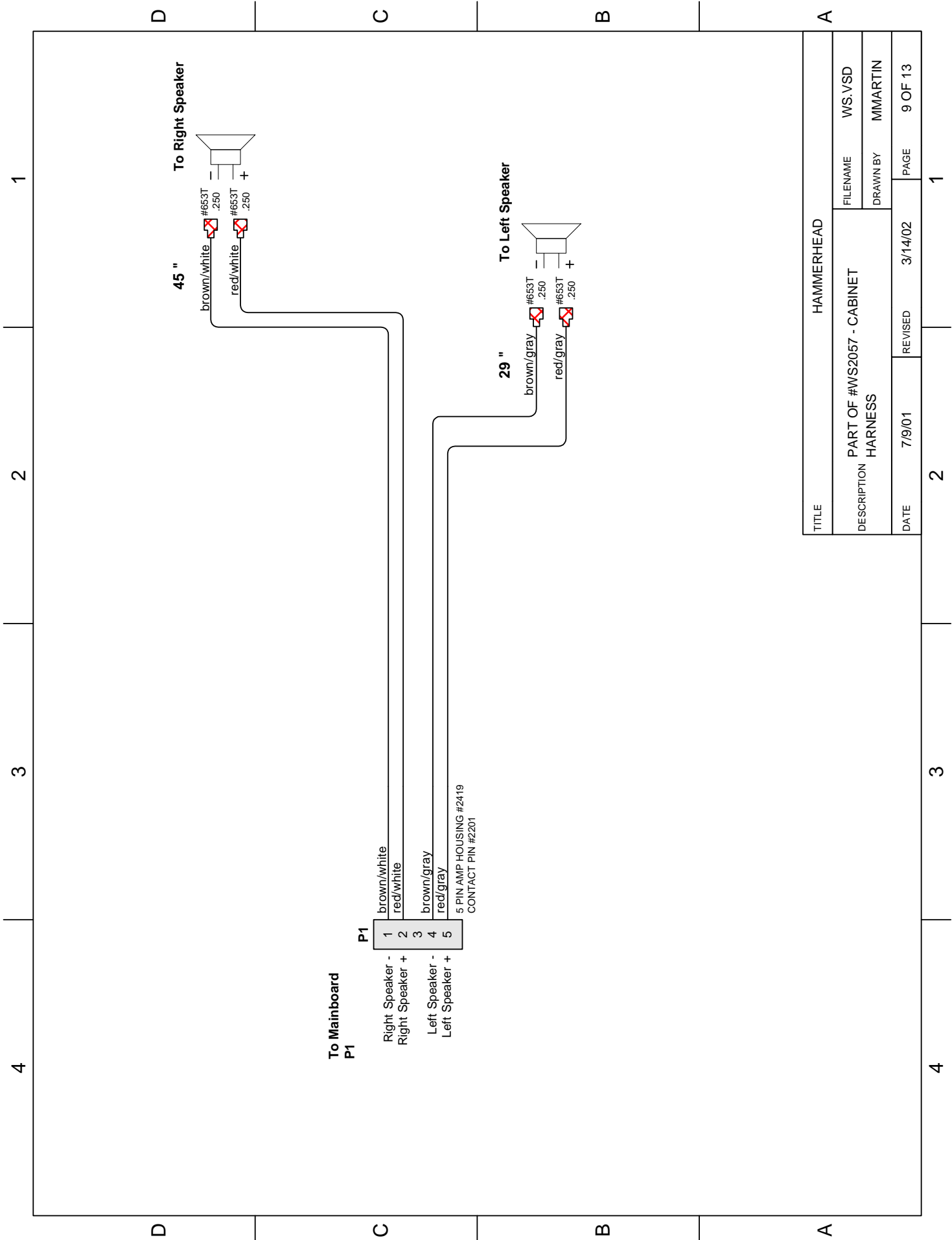

To Mainboard
P1

1	brown/white
2	red/white
3	brown/gray
4	red/gray
5	brown/gray

5 PIN AMP HOUSING #2419
 CONTACT PIN #2201

45 "
To Right Speaker

29 "
To Left Speaker

TITLE		HAMMERHEAD	
DESCRIPTION		FILENAME	WS.VSD
DATE		DRAWN BY	MMARTIN
REVISION		3/14/02	PAGE 9 OF 13

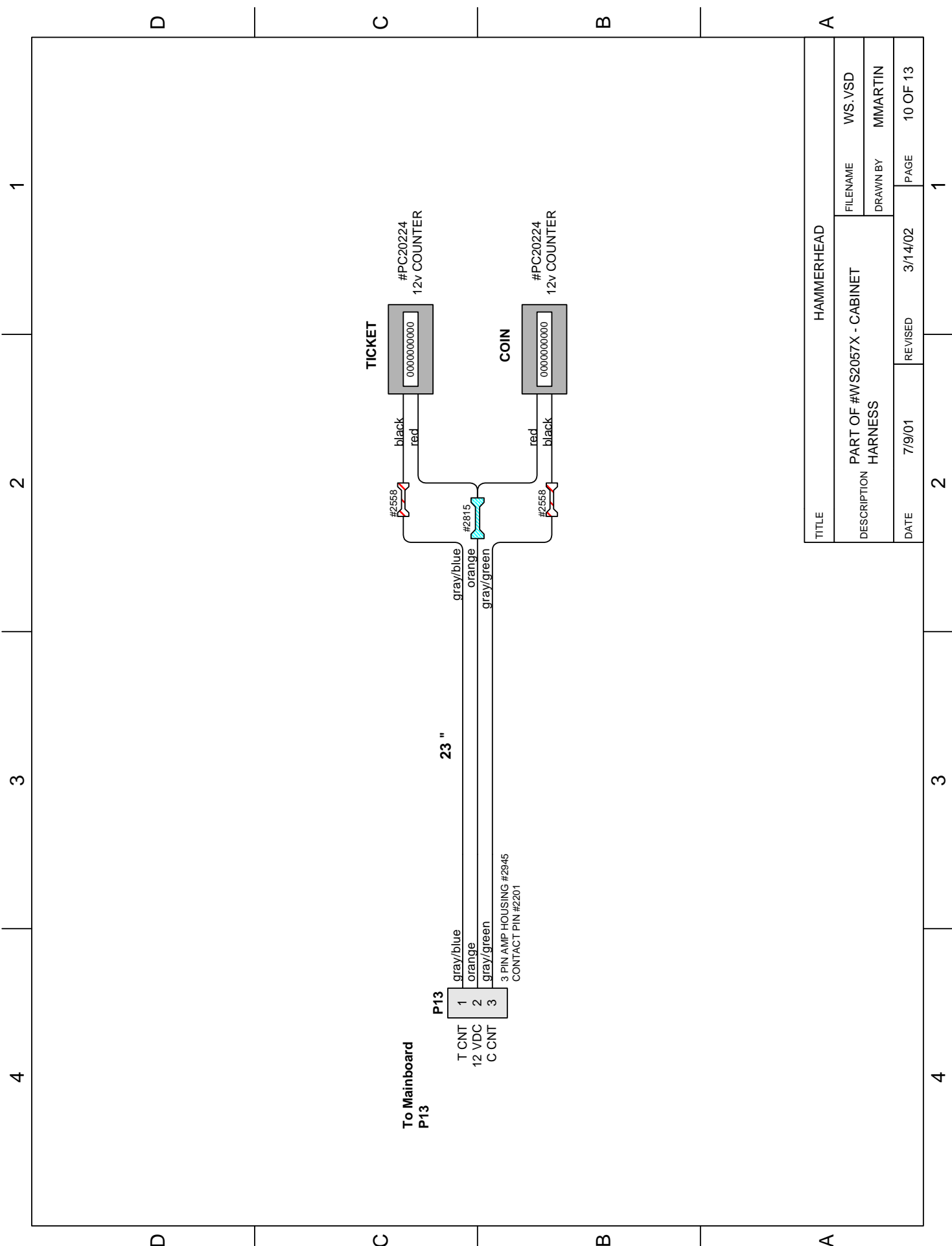

TITLE		HAMMERHEAD	
DESCRIPTION		FILENAME	WS.VSD
DATE		DRAWN BY	MMARTIN
7/9/01		REVISED	3/14/02
PAGE		10 OF 13	

1
2
3
4

D C B A

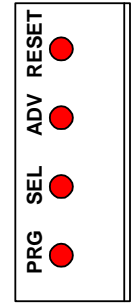
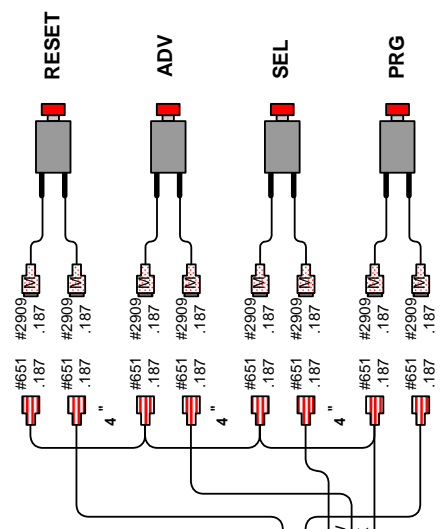

To Mainboard
P7

1	violet/brown	20"	violet/brown
2	violet/red	16-1/2"	violet/red
3	violet/orange	18"	violet/orange
4	violet/yellow	18-1/2"	violet/yellow
5	black	16-1/2"	black

#2714 5 PIN IDC

#2289X - BUTTON ASY

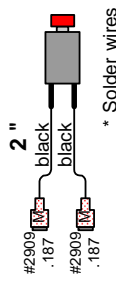

TITLE		HAMMERHEAD	
DESCRIPTION		FILENAME	WS.VSD
PART OF #W S2057X - CABINET HARNESS		DRAWN BY	MMARTIN
DATE	7/9/01	REVISED	3/14/02
PAGE		11 OF 13	

1
2
3
4

D C B A

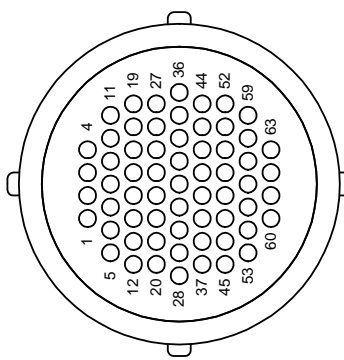
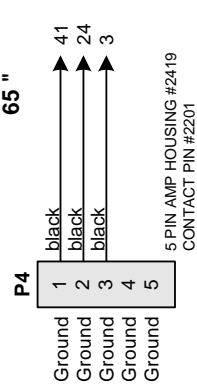
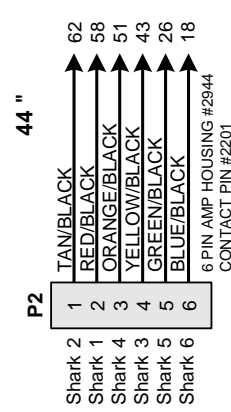
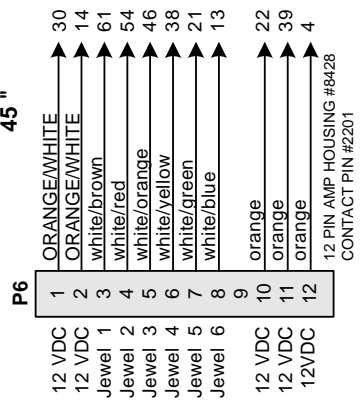
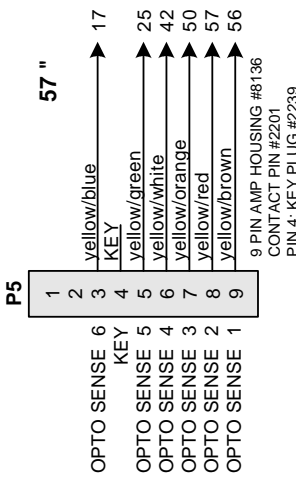
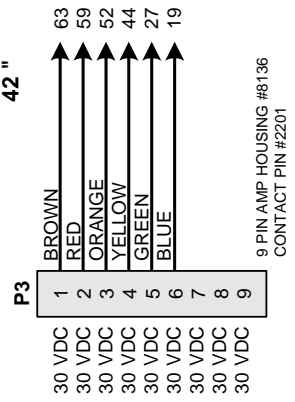
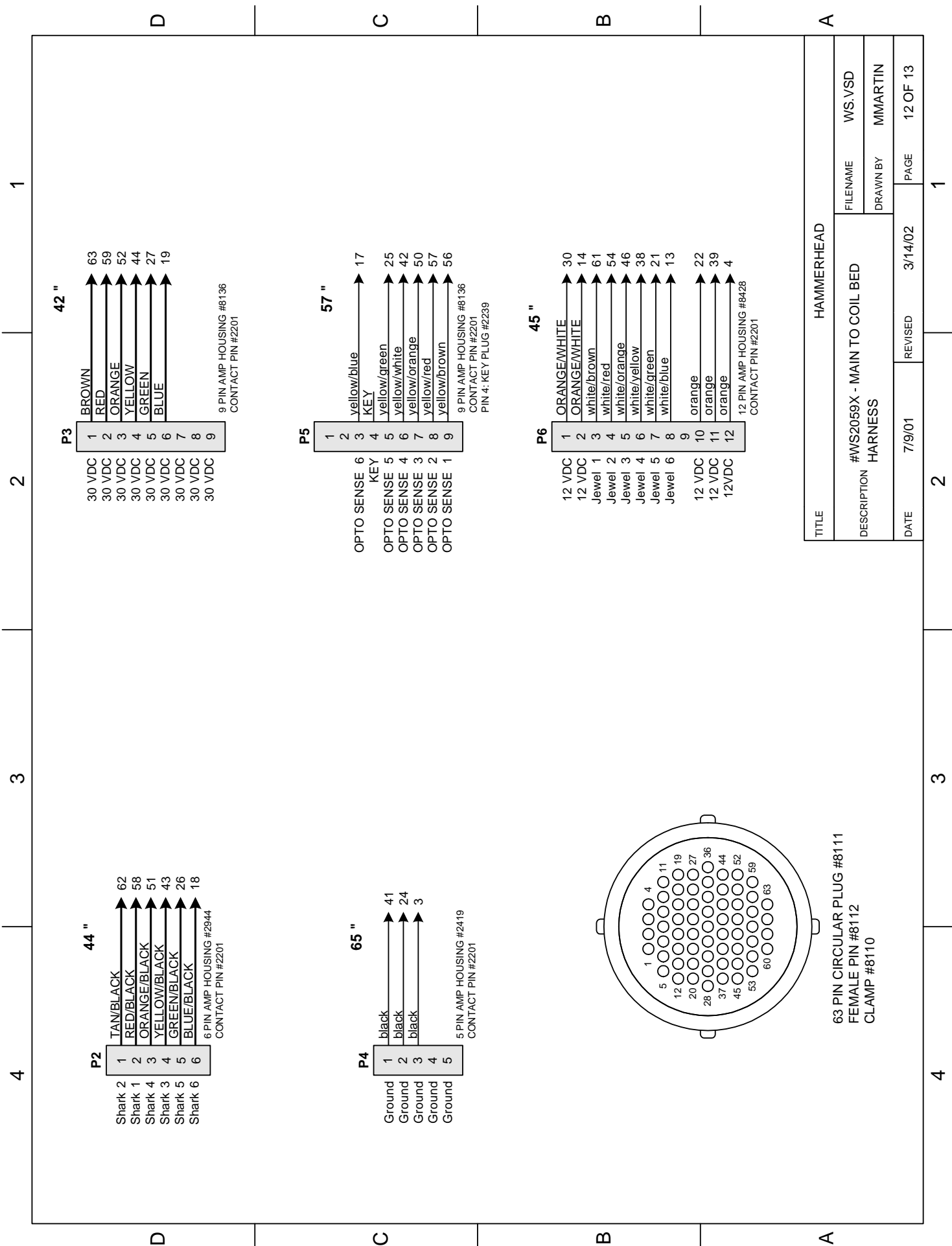

63 PIN CIRCULAR PLUG #8111
FEMALE PIN #8112
CLAMP #8110

TITLE		HAMMERHEAD	
DESCRIPTION	#WS2059X - MAIN TO COIL BED HARNESS	FILENAME	WS.VSD
DATE	7/9/01	DRAWN BY	MMARTIN
		REVISED	3/14/02
		PAGE	12 OF 13

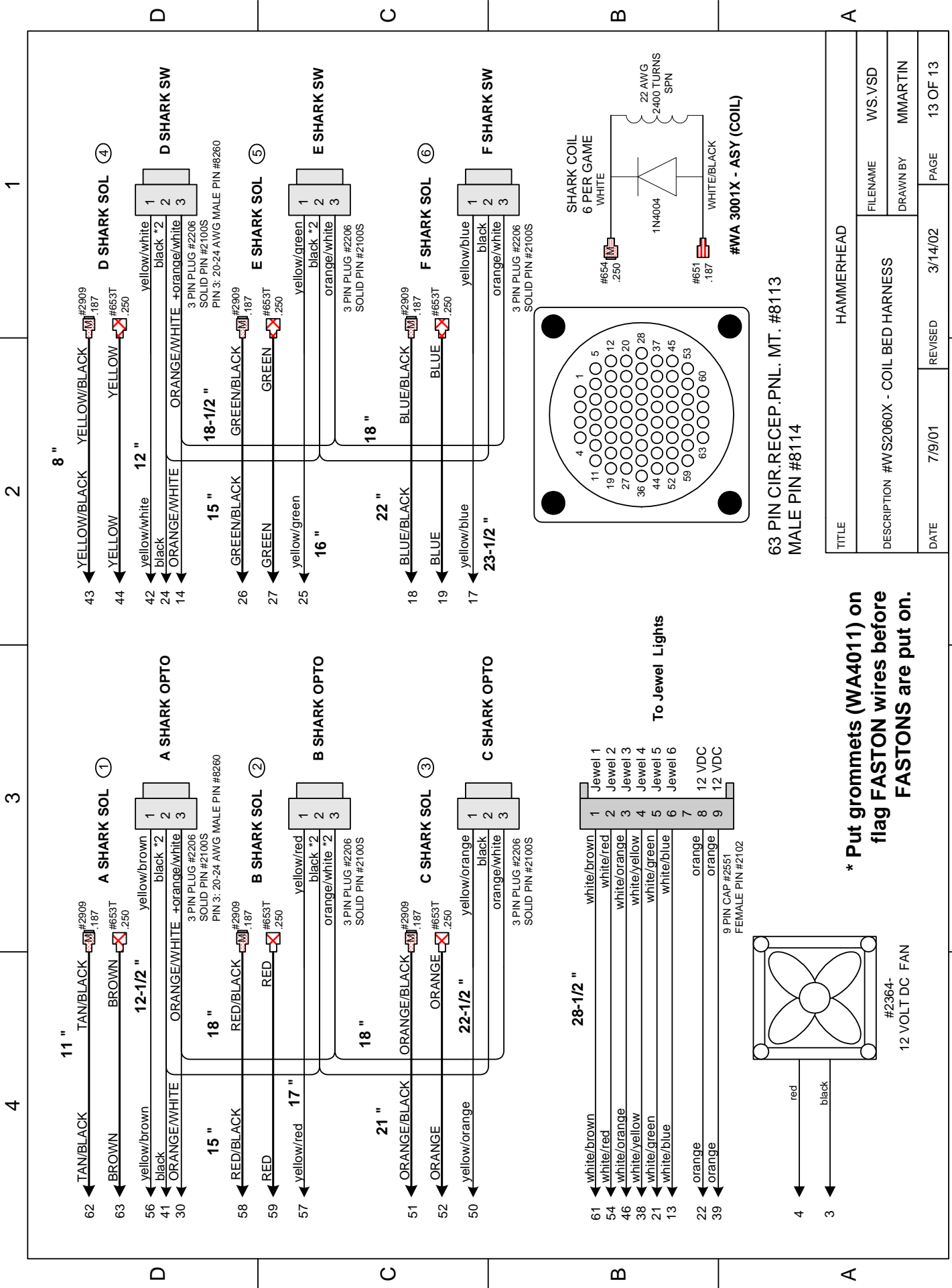

63 PIN CIR.RECEP.PNL. MT. #8113
MALE PIN #8114

*** Put grommets (WA4011) on flag FASTON wires before FASTONS are put on.**

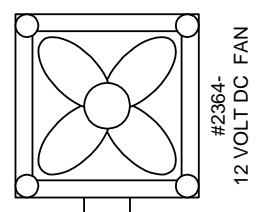

TITLE		HAMMERHEAD	
DESCRIPTION		FILENAME	WS.VSD
DATE		DRAWN/BY	MMARTIN
7/9/01	REVISED	3/14/02	PAGE
			13 OF 13

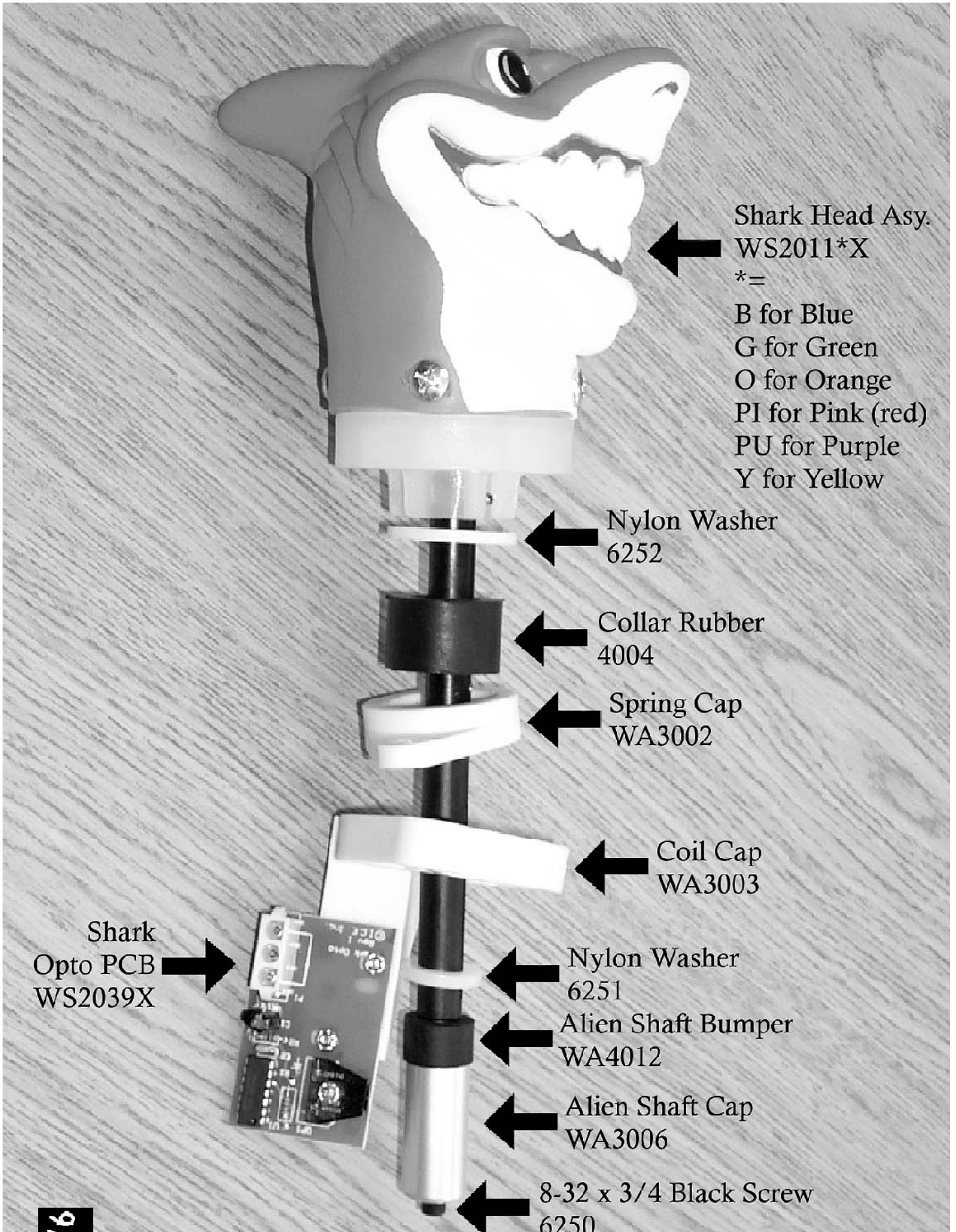



WARRANTY POLICY

I.C.E. Inc warrants all components in new machines to be free of defects in materials and workmanship for the period listed below:

- 180 days on Main PCB's, Computers & Motors
- 1 year on all LCD monitor panels
- 90 days on all other electronic and mechanical components
- 30 days on all I.C.E. repairs and parts purchases

I.C.E. Inc shall not be obligated to furnish a warranty request under the following conditions:

- Equipment or parts have failed through normal wear and tear
- Equipment has been subjected to unwarranted stress, abuse or neglect
- Equipment has been damaged as a result of arbitrary repair/modification

Products will only be covered under warranty by obtaining an I.C.E. authorized RMA #. To obtain an RMA # please provide I.C.E. tech support with the game serial # or original I.C.E. invoice # and a detailed description of the failure or fault symptoms.

I.C.E. Inc will assume no liability whatsoever for costs associated with labor or travel time to replace defective parts. All defective warranty covered components will be replaced with new or factory refurbished components equal to OEM specifications.

I.C.E. Inc will cover domestic UPS ground, or comparable shipping costs during the warranty period. International or expedited shipments are available for an additional charge. To obtain credit defective parts must be returned to I.C.E. Inc, at the customer's expense, within 30 days. After 30 days a 15% re-stocking fee will apply to all returns.

ICE distributors are independent, privately owned and operated. In their judgment, they may sell parts and/or accessories other than those manufactured by I.C.E. Inc. We cannot be responsible for the quality, suitability or safety of any non-I.C.E. part or modification (including labor) that is performed by such a distributor.

Innovative Concepts in Entertainment

10123 Main St.

Clarence, NY 14031

Phone #: (716) - 759 - 0360

Fax #: (716) - 759 - 0884

www.icegame.com