

Cyclone™



OWNERS AND SERVICE MANUAL **INNOVATIVE CONCEPTS IN ENTERTAINMENT INC.**

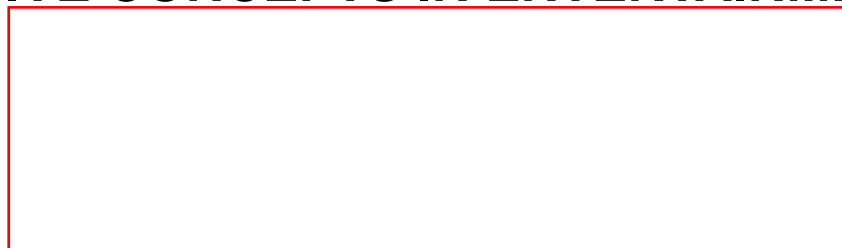

TABLE OF CONTENTS

INTRODUCTION.....	PAGE 3
• GAME FEATURES	
• GAME PLAY	
SET-UP / TESTING / MAINTENANCE.....	PAGE 4 - 9
• SAFETY PRECAUTIONS	
• GAME SET-UP	
• TESTING	
• CLEANING	
QUICK TROUBLESHOOTING.....	PAGE 10
• PROBLEMS AND SOLUTIONS	
GAME REPAIR.....	PAGE 11 - 17
• MECHANICAL REPAIR	
• ELECTRICAL / ELECTRONIC REPAIR BASIC	
• ADVANCE TECHNICAL INFORMATION	
PARTS LISTINGS.....	PAGE 18 - 23
SCHEMATICS / WIRING DIAGRAMS.....	PAGE 24 - 42
WARRANTY INFORMATION.....	PAGE 43 - 44

INTRODUCTION

GAME FEATURES

This game has many outstanding features making it the perfect game for just about any location.

The game was designed with the location in mind, featuring unparalleled flexibility in regards to custom game set-up and programming. Virtually all game play, and ticket dispensing options are operator adjustable, practically letting the operator “build his own game.”

CYCLONE™ has many unique features for the “Ticket Spitter” part of the game. Its Centerpiece design sets it apart from all other games in its category. Its Game Play, which is ALL SKILL, having no bounces, rolls, flips, or other chancy situations, also showcases its creative design. These and other features, give the players something that keeps them playing time and time again.

Reliability is the key word in the design of this game. The electronics in the game have been extensively tested to ensure years of trouble free service. The light ring light bulbs are powered using special circuitry and voltages to greatly enhance their life. The neon bulbs used should last over the life of the game.

The cabinet has been designed using only the finest materials available. The durable scratch resistant painted surfaces will last for years. The dome is made from LEXAN™, an almost indestructible material.

Game set-up is a snap. Just plug in, set a few programmable options, and you are ready to go. Even the programming options are easy to understand and adjust.

A “Tickets Owed Display” is used for each station to show tickets owed to the player. More on this feature is given in the game play section.

GAME PLAY

The game begins when the player has inserted enough money to create 1 “credit”.

The game has a ring of light bulbs encircling the playfield. A lit bulb encircles the field every second and a half. The object of the game is to stop the light between two neon arches located in the middle of the play zone.

Each light bulb zone has a “ticket” value associated with it. As you get closer to the two neon arches in the center of your zone, the ticket value increases. Between the two neon arches described above is the game JACKPOT. This is where a large number of tickets can be won.

Once the game begins you have one chance to stop the lights (for each credit inserted). Wherever the light stops is how many tickets the game pays out. Each time the jackpot is NOT hit, the jackpot value increases by one or more tickets, (if the incrementing jackpot option is selected). When the jackpot is hit, a jackpot routine including special lights and sounds is displayed.

Additional games can be played while tickets are dispensing.

The game also has a unique “Tickets Owed” display. This display has many uses. When tickets are won, the amount won are displayed, and then counted down as the tickets are dispensed. This is a handy feature in the event that the game runs out of tickets while dispensing, or if the game is out of tickets. If the game cannot dispense the tickets it should, it will keep adding the number it should dispense to the tickets owed display, and thus allow the player to continue playing the game until an attendant can be contacted. This feature is also very helpful if the “do not dispense tickets on jackpot” option is chosen. It may be desirable to NOT dispense tickets if the jackpot is set to a very high number of tickets. This will be valuable, as the number of jackpot tickets won would then be added to the display, then the ticket dispenser will lock until an attendant is located, and he resets the dispenser.

GAME SET-UP / TESTING

SAFETY PRECAUTIONS

IMPORTANT: FAILURE TO FOLLOW THESE DIRECTIONS CLOSELY COULD CAUSE SERIOUS DAMAGE TO YOUR GAME.

WARNING: WHEN INSTALLING THIS GAME, A 3-PRONG GROUNDED RECEPTACLE MUST BE USED. FAILURE TO DO SO COULD RESULT IN SERIOUS INJURY TO YOURSELF OR OTHERS. FAILURE TO USE A GROUNDED RECEPTACLE COULD ALSO CAUSE IMPROPER GAME OPERATION, OR DAMAGE TO THE ELECTRONICS.

DO NOT DEFEAT OR REMOVE THE GROUNDING PRONG ON THE POWER CORD FOR THE SAME REASONS AS GIVEN ABOVE. USING AN IMPROPERLY GROUNDED GAME COULD VOID YOUR WARRANTY.

PAY SPECIAL ATTENTION TO THE SET UP SECTION BELOW, REGARDING THE VOLTAGE SETTINGS.

GAME SET-UP

BEFORE PLUGGING THE GAME IN, OR TURNING IT ON, BE SURE THE GAME HAS BEEN SET TO THE PROPER VOLTAGE. YOUR GAME SHOULD COME PRE-SET FROM THE FACTORY TO THE CORRECT VOLTAGE, HOWEVER IT IS A GOOD IDEA TO CHECK THE A.C. WALL RECEPTACLE VOLTAGE BEFORE PLUGGING THE GAME IN.

The Game comes with 4 available voltage settings as described below. These settings should be used to provide power in the correct range to the game without over or under powering it.

<u>POWER RANGE</u>	<u>VOLTAGE SETTING</u>
90 – 110 V.A.C.	110
110 – 130 V.A.C.	120
200 – 220 V.A.C.	220
220 – 240 V.A.C.	240

The game uses a POWER MODULE to handle all of the power distribution chores on the game. It incorporates an ON-OFF switch, primary A.C. game fusing, and power switching capabilities, for using the game with a wide variety of A.C. voltages by re-strapping the main transformer.

A.C. LINE VOLTAGE ADJUSTMENT

To adjust the game for a different A.C. voltage:

1. Unplug the game from the outlet
2. Disconnect the power cord from the power module.
3. Using a small flat blade screwdriver, pry the fuse holder from the power module.
4. Notice a small window on the fuse holder with an arrow that points to the voltage the game is presently set at.
5. Using the small flat blade screwdriver, lift the retaining tab that holds the voltage selector in the fuse holder.
6. Rotate the voltage selector until the voltage you want is displayed in the voltage select window.
7. Push the voltage selector back into the fuse holder until it snaps into place. NOTE: Do not force the selector into the fuse holder. If it does not go in easily, it is not being installed correctly.
8. Snap the fuse holder assembly back into the power module.
9. Plug the power cord back into the receptacle in the power module, and into the wall outlet.

NOTE: WHEN CHANGING FROM 110-120 TO 220-240, LOWER THE MAIN FUSE VALUE BY ½.

WHEN CHANGING FROM 220-240 TO 110-120, DOUBLE THE MAIN FUSE VALUE.

GAME SET-UP / TESTING

PROGRAMMING YOUR GAME

This section will give you a detailed explanation of the functions and operating characteristics of each of the programming buttons. Please read this section carefully to avoid problems with your game.

NOTE: THE PROGRAMMING BUTTONS SHOWN BELOW MAY BE LOCATED EITHER ON THE MAIN P.C. BOARD AS ILLUSTRATED, OR ON A CONTROLL BRACKET ATTACHED TO THE BLUE ACCESS DOOR.

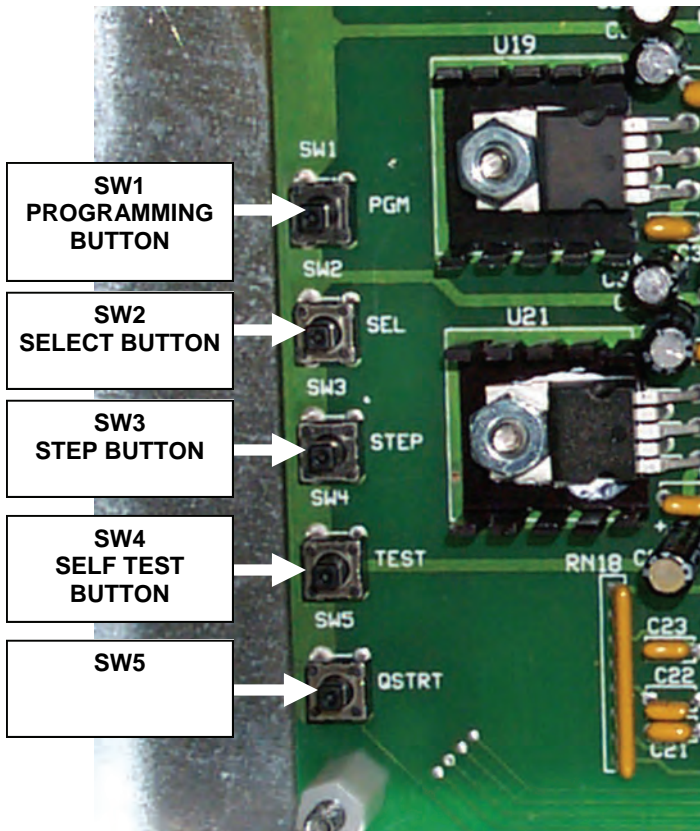

PROGRAMMING BUTTON (SW1)

This button is used to enter the "Programming" mode. It is located on the Main P.C. Board in the lower left hand corner, or on the blue access door of the game. Press this button once to enter the programming mode.

Once in this mode you can push SW2 or SW3 to make adjustments to the game.

To exit the programming mode and return to game play, push this button once again.

SELECT BUTTON (SW2)

This button is used to advance through all of the various programming option modes. Each push of this button, will move you to the next programmable option. The option number is displayed on the large "JACKPOT" display.

STEP BUTTON (SW3)

Each push of this button will advance you to the next available "value" for a particular programmable option. The value for that option is shown on the smaller "TICKETS OWED" display located on the control panel.

SELF TEST MODE (SW4)

When this button is pressed, the game goes into "Self Test" mode. In this mode, the game will advance the lights slowly, so it is easier to see if any light bulbs have burned out. Also, each push on any of the control panel push buttons will activate a sound, to test each game sound as well as each push button.

QUICK START (SW5)

When this button is pushed, a game will play, however NONE OF THE TICKET DISPENSERS, OR ANY COUNTERS WILL WORK. This allows game testing with out affecting accountability. If ticket dispensers must be tested, then a normal game must be played.

GAME SET-UP / TESTING

OPTION MODES

Please read the setting information carefully BEFORE making any adjustments. Failure to set options properly can yield unexpected results.

PLEASE NOTE: THE VALUES PRE-SET AT THE FACTORY HAVE BEEN FOUND TO WORK BEST FOR MOST LOCATIONS.

MODE 1 (COINS PER CREDIT)

The number set in this option, is the number of coins necessary to earn 1 credit and play 1 game. Setting a "0" in this mode will set the game in "Free Play" mode. The default for this mode is "1".

MODE 2 (VOLUME)

The number set in this mode controls the relative volume of sound. "0" equals the minimum, "9" equals the maximum. As this button is pushed, a sound is played to make it easier to determine where the volume should be set. The default for this mode is "5".

NOTE: THE SOUND IN THIS GAME CANNOT BE COMPLETELY TURNED OFF.

MODE 3 (ATTRACT MODE)

The attract mode in this game consists of the theme song being played whenever called to do so by the game program. The numbers in this mode represent minutes between attract modes. Setting a "0" in this mode turns the attract mode off. The default value in this mode is 3.

MODE 4-29 (ZONE VALUES)

The playfield is broken up into 3 "sections", 1 for each player station. Within each section, lies the center "Jackpot" zone, with a series of 26 lights, 13 to either side of it. Each light has a point value associated with it. Each light can be independently set for a point value different from that set at the factory. Each of these lights is a separate "zone".

Below is a table that indicates the 26 zones for each player station, and the associated "mode" number for each. Zone 1 is the furthest zone from the Jackpot to the left, while zone 26 is the furthest zone from the jackpot to the right. Also in this table, are the default values for each zone.

LIGHT RING ZONE VALUES

MODE	ZONE	DEFAULT
4	1	1
5	2	2
6	3	2
7	4	3
8	5	3
9	6	4
10	7	4
11	8	5
12	9	5
13	10	6
14	11	7
15	12	8
16	13	10
17	14	10
18	15	8
19	16	7
20	17	6
21	18	5
22	19	5
23	20	4
24	21	4
25	22	3
26	23	3
27	24	2
28	25	2
29	26	1

Each zone can be set from 0 to 20. If values are changed from the factory default settings, it will be necessary to change the numbers indicated on the game by using the supplied decal overlay sheets.

GAME SET-UP / TESTING

MODE 30 (INITIAL JACKPOT VALUE)

The value shown is the value of the Jackpot (zone between the 2 center arches) when the game is first powered up, or just after a Jackpot is won. The default value for this mode is "100".

MODE 31 (JACKPOT INCREMENT)

The number shown here, is the amount of tickets the Jackpot value will increase by each time the game is played, and the Jackpot IS NOT WON. Setting a "0" for this mode will turn the incrementing feature off. Default for this mode is "1".

MODE 32 (JACKPOT CAP)

The number shown in this mode is the maximum amount of tickets the game can dispense when hitting the Jackpot. Setting a "0" turns the cap off. The default value for this mode is "0".

MODE 33 (JACKPOT LOCK-UP)

This option allows the operator the choice of whether or not to dispense tickets when the jackpot is hit.

If the operator normally sets the jackpot to a very high value, he may not wish to dispense the tickets when the jackpot is hit. If the game has a lower Jackpot set, it is a good idea to let the game dispense tickets by itself.

It is usually better to let the game dispense tickets, as part of the fun of the game is watching all those tickets come out when the jackpot is hit.

Setting a "1" dispenses tickets. Setting a "0" does not allow ticket dispensing when the Jackpot is hit.

NOTE: WHEN THE GAME IS SET TO NOT DISPENSE TICKETS, THE TICKET DISPENSER RESET BUTTON MUST BE PRESSED AGAIN FOR THE GAME TO RESUME DISPENSING ANY TICKETS AT THAT STATION. EACH PLAYER STATION HAS A RESET BUTTON LOCATED ON THE COIN MECH HOLDER.

MODE 34 (JACKPOT DIFFICULTY)

To make the game easier or harder to win, this option should be adjusted. The value displayed is equal to how many milliseconds the "WINDOW" to win the Jackpot is open. (A millisecond is 1/1000 of a second.) A setting of "1" is the hardest and a setting of "20" is the easiest. The default value for this mode is "3".

MODE 35 (JACKPOT WINABILITY)

This mode adds a valuable feature to those locations that have large variations in age groups. Under the normal circumstances, the operator sets up MODE 34 for the best payout for his location. However this may be difficult for some age groups. There are also circumstances where the operator may want the jackpot to be won on an average of XXX amount of games. This option will allow for that. When this option is selected, no matter what window value is chosen in MODE 34, the game will open the window up to 20 milliseconds (easiest) every XXX games. Every XXX games, is the number you choose on this setting. A setting of "0" turns this option off. The default setting for this option is "0".

MODE 36 (CREDIT DISCOUNTING)

When this mode is enabled, the game will give you 1 free credit for every XXX coins inserted into the game AT ONCE. A setting of "0" turns this mode off.

Example: If "2" is chosen, for every 2 coins inserted, 1 free game will be given. If "4" is chosen, for every 4 coins inserted, 1 free game will be given.

The default value for this option is "0".

MODE 37 (JACKPOT MEMORY)

This option allows the game to revert to the initial Jackpot value, (see mode 17) or keep the last value shown on the display when the game is shut off. Setting a "0" resets the value, setting a "1" retains the value. The default value is "1".

GAME SET-UP / TESTING

MODE 38 (RESET ALL)

When this mode is selected, the game will revert to all factory default settings.

SET "1" THEN EXIT PROGRAMMING MODE TO RESET ALL VALUES TO FACTORY DEFAULT.

The default value for this mode is "0".

TESTING

After the initial programming adjustments have been made, it's time to test your game for proper operation.

1. Locate the game to its permanent location.
2. Be sure the game has been properly plugged into a 3 prong grounded outlet, and that the receptacle is in good working order.
3. If using an extension cord, be sure it is a 3-prong grounded type of at least 16 Ga. materials.
4. Adjust the leg levers and lock into position.
5. Verify that the game is set up for proper voltage, and the power to the game is on.
6. Insert coins at least ten times into each coin mechanism to assure proper operation. An audible sound should be heard each time a coin is dropped.
7. Check the coin counter (located inside the blue coin door) and check for proper operation.
8. Run tickets through each ticket dispenser by playing games at each station. Check that tickets do not get stuck behind ticket louver.
9. Check each ticket counter for proper operation.
10. Check to see that the proper amount of tickets are dispensed based on the numbers shown on the playfield.
11. Check that all door locks work smoothly.
12. Check game volume during busy time at location to set it at the proper level.

IF YOU HAVE ANY QUESTIONS OR COMMENTS REGARDING INSTALLATION OR PROPER FUNCTION OF THE GAME, PLEASE CALL OUR SERVICE DEPARTMENT AT 1-716-759-0360

MAINTENANCE

GENERAL MAINTENANCE

This game has been designed for an absolute minimum amount of maintenance.

The light ring light bulbs have been designed into the game in such a fashion as to greatly extend their life. However, eventually they will reach the end of their life span. When this time comes, you will notice that 2 or 3 bulbs have burned out within a couple of weeks time from each other. At this point, it is advisable to change all of the bulbs. The bulbs are a very simple push in type, very easy to change, and very inexpensive. Changing all of the bulbs at once, will save you work in the long run, and keep the game looking good.

CLEANING

Regular cleaning of the game will keep it looking new, and greatly enhance its appeal.

Clean the dome with a spray type furniture polish. Pledge™ is a very good cleaner. It will fill in minor scratches, and give the plastic surface a deeper, clearer look. Avoid using glass cleaners, as they dry out the plastic and give it a hazy look.

Clean the cabinetry with a good cleaner such as Fantastik™ or 409™ and a soft rag. A mild soapy solution can also be used.

NOTE: DO NOT USE ALCOHOL, THINNERS OF ANY KIND, OR PINBALL PLAYFIELD CLEANERS ON ANY OF THE CABINET SURFACES, ESPECIALLY THE DECALS.

QUICK TROUBLESHOOTING

PROBLEM	PROBABLE CAUSE	SOLUTION
NO GAME POWER	ON-OFF SWITCH ON THE GAME IS TURNED OFF BLOWN A.C. POWER FUSE GAME NOT PLUGGED OR CORD DAMAGED BAD TRANSFORMER TRANSFORMER HARNESSING NOT CONNECTED BAD POWER MODULE	TURN POWER ON REPLACE WITH PROPER FUSE CHECK POWER CORD CHECK FOR PROPER VOLTAGES CHECK HARNESS REPLACE POWER MODULE
GAME WILL NOT TAKE MONEY OR GIVE CREDITS CORRECTLY	BAD COIN SWITCH COIN DISCOUNTING SET WRONG COINS PER CREDIT SETTING INCORRECT BAD COIN MECHANISM LOOSE OR DAMAGED HARNESSING BAD MAIN P.C. BOARD BAD 5 VOLT POWER SUPPLY FUSE	CHECK W/METER AND REPLACE CHECK PROGRAMMABLE SETTING CHECK PROGRAMMABLE SETTING ADJUST OR REPLACE CHECK W/METER—REPAIR REPAIR OR REPLACE MAIN BOARD CHECK AND REPLACE FUSE
TICKETS DO NOT DISPENSE OR DISPENSE INCORRECTLY	ZONE VALUES SET UP INCORRECTLY TICKET RESET BUTTON NOT PUSHED TICKET DISPENSER OPTICAL DIRTY TICKET DISPENSER HARNESSING BAD TICKET DISPENSER BAD BAD MAIN P.C. BOARD BAD 5 VOLT POWER SUPPLY FUSE	CHECK PROGRAMMABLE SETTING PRESS RESET BUTTON CLEAN OPTICAL SENSOR CHECK W/METER AND REPAIR REPLACE DISPENSER REPLACE MAIN P.C. BOARD CHECK AND REPLACE FUSE
NEON BULBS DO NOT LIGHT	BAD NEON BULB BAD NEON P.C. BOARD BAD MAIN P.C. BOARD BAD NEON POWER SUPPLY FUSE BAD NEON HARNESSING BAD 5 VOLT POWER SUPPLY FUSE	TEST BULB AND REPLACE REPLACE NEON P.C. BOARD REPLACE MAIN P.C. BOARD CHECK AND REPLACE FUSE CHECK W/ METER AND REPAIR CHECK AND REPLACE FUSE
RING LIGHT BULBS DO NOT LIGHT	BAD LIGHT BULB BAD LIGHT RING P.C. BOARD BAD INTERCONNECT HARNESSING BAD MAIN P.C. BOARD LIGHT RING POWER SUPPLY FUSE BAD BAD 5 VOLT POWER SUPPLY FUSE	REPLACE LIGHT BULB REPLACE LIGHT RING P.C. BOARD CHECK W/METER AND REPAIR REPAIR OR REPLACE P.C. BOARD CHECK AND REPLACE FUSE CHECK AND REPLACE FUSE
SCORE DISPLAYS DO NOT WORK	BAD 12 VOLT STATION FUSE BAD 5 VOLT POWER SUPPLY FUSE BAD SCORE DISPLAY P.C. BOARD BAD MAIN P.C. BOARD BAD SCORE DISPLAY HARNESSING	CHECK AND REPLACE FUSE CHECK AND REPLACE FUSE REPAIR OR REPLACE P.C. BOARD REPAIR OR REPLACE P.C. BOARD CHECK W/METER AND REPAIR
JACKPOT LIGHT DOES NOT LIGHT	BAD 12 VOLT STATION FUSE BAD 5 VOLT POWER SUPPLY FUSE BAD SCORE DISPLAY P.C. BOARD BAD MAIN P.C. BOARD BAD SCORE DISPLAY HARNESSING	CHECK AND REPLACE FUSE CHECK AND REPLACE FUSE REPAIR OR REPLACE P.C. BOARD REPAIR OR REPLACE P.C. BOARD CHECK W/METER AND REPAIR
LOW / NO TICKET INDICATOR DOES NOT WORK	BAD INDICATOR L.E.D. L.E.D. INSTALLED BACKWARDS STATION HARNESSING BAD TICKET MICRO SWITCH BAD MAIN P.C. BOARD BAD	REPLACE L.E.D. REVERSE L.E.D. CHECK W/METER AND REPAIR REPLACE MICRO SWITCH REPAIR OR REPLACE P.C. BOARD
STORM STOPPER BUTTON DOES NOT STOP LIGHT	BAD BUTTON SWITCH BAD HARNESSING BAD MAIN P.C. BOARD	REPLACE SWITCH CHECK W/METER AND REPAIR REPAIR OR REPLACE P.C. BOARD

GAME REPAIR

WARNING: ALWAYS REMOVE POWER TO THE GAME BEFORE ATTEMPTING ANY SERVICE, UNLESS NEEDED FOR SPECIFIC TESTING. FAILURE TO OBSERVE THIS PRECAUTION COULD RESULT IN SERIOUS INJURY TO YOURSELF OR OTHERS.

OPERATIONAL BACKGROUND

The **CYCLONE™** coin operated amusement game has been designed for an absolute minimum of service. Special circuitry prolongs the life of the incandescent light bulbs. In addition, the neon bulbs have a life span measured in years.

The Main P.C. board has been designed with 7 separate P.C. mounted power supplies, to segregate different areas of the electronics. In other words, if 1 station goes down, the other 2 stations will continue to work. If the sound goes down, the rest of the game will continue to play, etc. Additionally the power supplies are all fan forced cooled.

The Light Ring P.C. Boards were designed to add reliability to the game, by eliminating the massive amount of wiring that would be needed for the 84 light ring bulbs used. The light sockets on the board were chosen to allow for the least expensive bulbs possible to be used. The boards were designed to change quickly and easily in the unlikely event that something goes wrong with one of them.

TROUBLESHOOTING PHILOSOPHY

To find problems with this game, always first check what should be obvious. See that the game is plugged in, and all of the fuses on the game are good. This includes the fuse that is located **INSIDE** the power module.

Next, check to see that all of the connectors are firmly seated, and that none of the wires have pulled out of them.

When trying to find out if specific components are bad or not, try swapping them with components from another player station to see if the problem moves with the component, or stays where it was. This will help you to know if you have a problem with a specific component, or maybe a problem with either the wiring or the Main P.C. Board.

Use extreme caution when using probes or volt meters if the game is powered up. If doing continuity checks, it is important to disconnect the harnessing at both ends, as attached they may yield erroneous results.

If P.C. Boards are suspected as causing problems, check to see that all I.C. chips are firmly seated on the boards.

If light bulbs are suspected, swap them with one that is known to work to narrow the problem down to bulb or P.C. Board.

MAIN P.C. BOARD REPLACEMENT

1. Remove all A.C. power from the game.
2. Carefully remove all of the connectors from the P.C. Board.
3. Remove the 4 long hexagon nuts that secure the board to the mounting bracket.
4. Gently pull the P.C. board from the mounting bracket.
5. Re-install in the reverse order.

LIGHT RING P.C. BOARD REPLACEMENT

NOTE: BE EXTREMELY CAREFUL NOT TO HIT A NEON BULB SOCKET FROM THE BOTTOM, AS THEY ARE RELATIVELY FRAGILE.

1. Remove all A.C. power to the game.
2. Remove the harnesses to the suspected bad P.C. Board.
3. Remove the light bulbs from the bad board.
4. Remove the 4 screws that hold the P.C. board to the bottom of the play field.
5. Re-assemble in reverse order.

GAME REPAIR - BASIC

NEON BULB REPLACEMENT

WARNING: NEON TRANSFORMERS EMIT HIGH VOLTAGE.

BE CAREFUL WHEN SERVICING NEON TUBES AS THEY ARE MADE OF GLASS AND ARE THEREFORE VERY FRAGILE.

1. Remove all A.C. power to the game.
2. Remove the 2 single pin mate-lock connectors that connect the bad bulb to the neon transformer P.C. board.
- 3a. For "U" shaped bulbs, remove the 2 nuts that secure the sockets to the playfield.
- 3b. For pie shaped neon tubes, unsnap the neon from the standoffs.
4. Remove the old neon and pull the wires up through the mounting or access holes.
5. When re-assembling the "U" shaped neon tubes, be sure to use the foam washer. **NOTE: INSTALL THE MOUNTING NUTS LOOSELY. THE NEON SHOULD ROCK BACK AND FORTH SLIGHTLY WHEN INSTALLED PROPERLY.**
6. When re-assembling the pie shaped neon tubes, snap the neon into the standoffs evenly, the 2 closest to the outside first, then the 2 closest to the center.
7. Re-connect the wires to the neon transformer P.C. board and test for proper operation.

NEON TRANSFORMER P.C. BOARD REPLACEMENT

NOTE: BE CAREFUL WHEN SERVICING THE NEON TRANSFORMER P.C. BOARD, AS THE BOARD CONTAINS SMALL DIAMETER WIRES THAT COULD BECOME BROKEN WITH ROUGH HANDLING.

BEFORE REMOVING ANY CONNECTORS, NOTE EXACTLY WHERE THEY WERE REMOVED FROM, SO THE LIGHTS WILL LIGHT IN THE PROPER SEQUENCE WHEN RE-INSTALLED.

1. Remove all A.C. power from the game.
2. Remove the Harnessing from the Main P.C. Board with the mate-lock connectors.

3. Remove the 3, six pin mate-lock connectors.
4. Remove the 6 single pin mate-lock connectors.
5. Remove the 4 corner screws that hold the neon board to the bottom of the playfield. **NOTE: THE 4 SCREWS IN THE CENTER OF EACH SIDE OF THE BOARD DO NOT COME OUT.**
6. Re-assemble in reverse order. **NOTE: BE SURE THE BULBS LIGHT IN THE PROPER SEQUENCE, AS DESCRIBED BELOW.**

BULB SEQUENCE

1. The neon arches in the center of each Jackpot should alternately flash on and off.
2. The neon arches between the 3 player stations should remain lit.
3. When the Jackpot is hit, the neon bulbs should pulse from the far side of the game, to the Jackpot area.
4. The pie shaped neon should light only when the ring light is lit in its zone.

CONTROL PANEL P.C. BOARD REPLACEMENT

1. Remove all A.C. power to the game.
2. Remove the two mate-lock connectors to the P.C. board.
3. Remove the 4 long hexagon nuts that hold the board to the bottom of the control panel.
4. Carefully slide the board from the mounting studs.
5. Re-assemble in reverse order.

JACKPOT DISPLAY P.C. BOARD REPLACEMENT

1. Remove all A.C. power to the game.
2. Remove the Dome.
3. Remove the four screws that hold the printed filter on the Jackpot display housing.
4. Remove the 4 hexagon screws that hold the Board to the housing, and remove the board.
5. Remove the mate-lock connectors.
6. Re-assemble in reverse order

Cyclone Advance Technical Information

Light Ring Is Dim Or Not Lighting:

Step 1: Check fuse F3, and make sure the fuse holder is in good condition.

Step 2: Check voltage on VR3 and VR4 (VR4 is located directly below the fan on the main board) for an output of 13vdc. You can do this by placing your black lead of your voltmeter on the ground wire (black wire) for the main board fan, then touching the top of the voltage regulator with the red lead of your meter. If one or both of your regulators are below 11vdc then BOTH VR3 and VR4 need to be replaced. If the voltage is above 11vdc you may be able to get your voltage up to 13vdc by loosening and tightening the bolts holding the voltage regulator to the board and the heat sink.

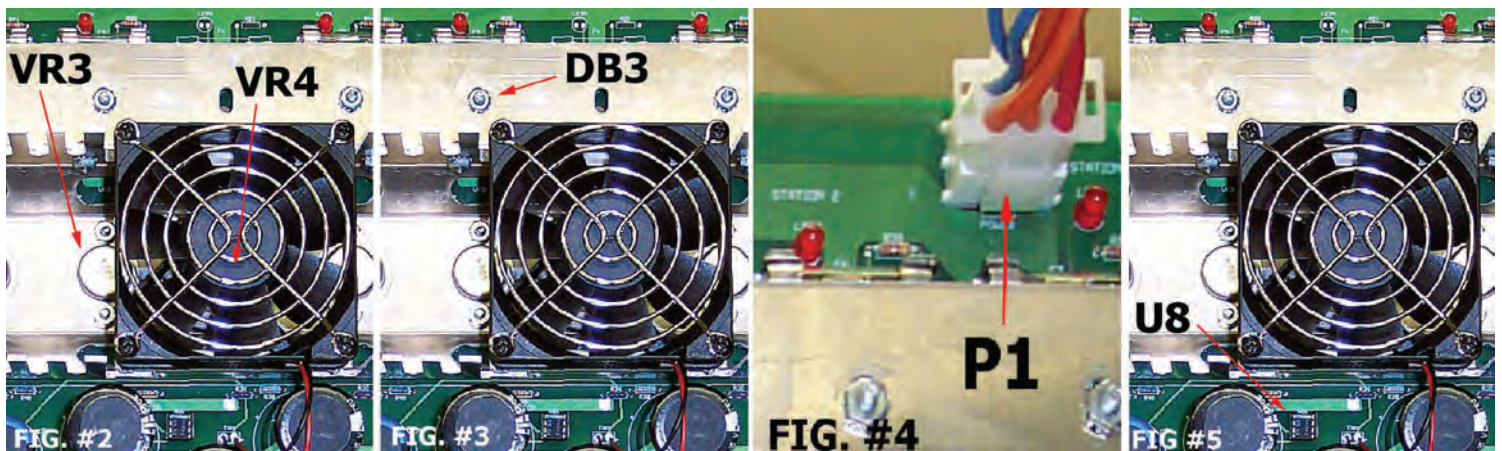

Step 3: Check the output of DB3 (located below the heat sink) for approximately 15 volts of unregulated DC. You can do this by measuring the voltage on resistors R49 and R50. These are located on either side of DB3.

Step 4: Check connector P1 for approximately 18 VAC across pins 1 and 5 (red and orange colored wires), and pins 4 and 6 (also red and orange). Remember this is AC voltage so set your meter accordingly.

Step 5: Check light ring harnessing for possible damage (exposed, broken or shorted wiring) and repair/replace as necessary.

Step 6: Check the light ring PCB's. To test the light ring boards you'll need to narrow down where the problem could be. First you need to identify what board is where. Open the blue coin door and look up at the bottom of the playfield. You'll see 6 light ring boards, with board #1 to the left of the blue coin door, and board #6 to the right. The boards are in numeric order going counter-clockwise from this view. Now disconnect the jumper wires between boards #1 and #2. Now only board #1 will light (seeing the light rings are only a "display" of where the main board is calculating the light to be, board #1 will light as if it was connected to the other five boards, if the board is working properly).

Cyclone Advance Technical Information

Step 6 (CONT): If board #1 works correctly, then replace the jumper between boards #1 and #2 and remove the jumper wires between boards #2 and #3. Boards #1 and #2 should light accordingly. Continue this troubleshooting process until either you have verified the light rings are operating properly or you find the board(s) that is causing your issue. If you find a board that doesn't light, shuts down the light ring, or dims the light ring, it is either the board you just connected or the board before it in the chain.

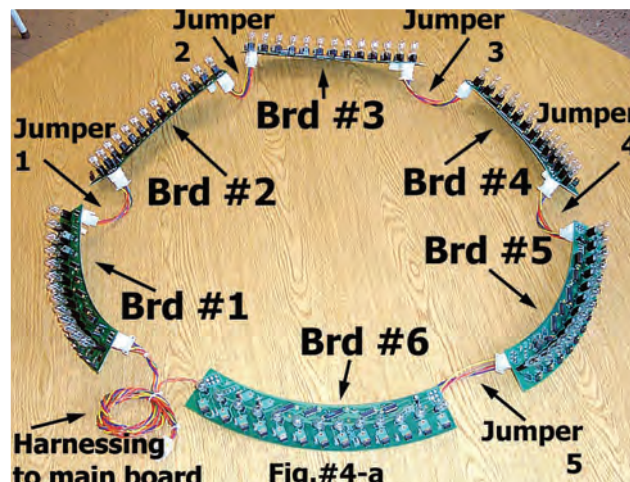

Step 7: Try replacing U8 on the main pcb (this chip balances the regulators VR3 and VR4). If this chip failed it may be forcing one of the regulators to be "overworked" and that overworked regulator is failing prematurely. This would lead to replacing U8, VR3, and VR4.

No Power To One Station:

Step 1: Check fuse (F5 for Blue station, F6 for the Pink Station, and F7 for the green station).

Step 2: Check diode bridge (DB5 for Blue station, DB6 for Pink station, and DB7 for the green station) for an output voltage of approximately 15 unregulated VDC.

Step 3: Check voltage regulator (VR5 for Blue station, VR6 for Pink station, and VR7 for Green station) for an output of 12 VDC (measure this voltage the same way as described in section 2 of the Light Ring Is Dim Or Not Lighting).

Step 4: Make sure there is no damage to the wiring from the main PCB to the inoperable station. On the station connector (P2 for the Blue station, P3 for the Pink station, and P4 for the Green station) verify there is 12 VDC across pin 1 (+12 VDC) and pin 7 (ground).

Step 5: Try swapping station connectors at the main PCB. This will help identify if there is an issue with the station or the main pcb.

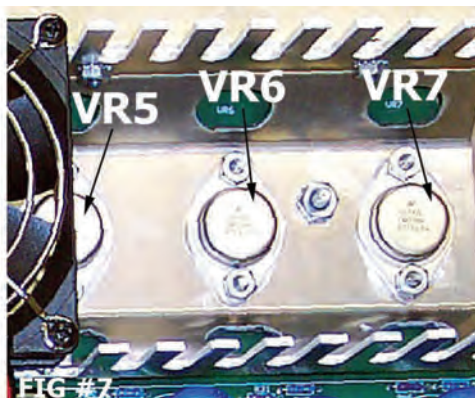

Cyclone Advance Technical Information

No Ticket Dispense/Constant Ticket Dispense On One or More Stations:

Try swapping ticket mechs or ticket mech boards between a station that works and the station that doesn't. This will help verify if you issue is a main PCB or a ticket mech issue. Check the station wiring between ticket dispenser and main PCB for damage and/or swap station connectors to see if problem follows the switch.

Make sure ticket mech is getting 12 VDC from the main PCB, if no voltage is present check harnessing to station connector and/or see No Power to One Station section above.

Swap chips U13 and U15 on the main PCB. These chips control various output signals, with your ticket run signal coming from U13. After swapping these chips if your ticket mech runs properly then replace the chip that was originally in the U13 socket.

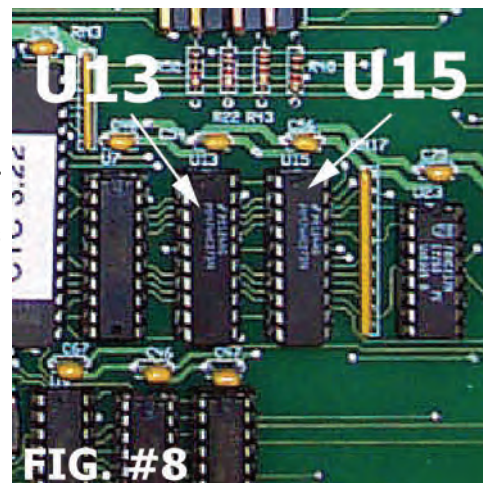

Scrambled Displays:

Swap display with known working display from another station. If problem follows display board, then replace display.

Try disconnecting the main to neon harness (connector P7 on main board). If your game has any bad neon bulbs, neon harnessing, or blown components on neon board, the neon circuits may be transmitting high frequency noise. This noise can interfere with clock, data and latch information going to the display boards. If you disconnect the harness for the neon at connector P7 on the main board and the displays begin to operate properly, you will need to check all harnessing, bulbs, and the neon board for damaged wiring, exposed wiring or damaged components on the neon board. You may also want to check the neon ballasts on the neon controller board. There are four wires coming of each of the 12 ballasts. If these wires are touching, they can, in some cases, also cause noise.

Swap chip U23 on the main board with a known working chip. This chip splits the clock pulse into 5 separate signals, one for each station, one for the light ring and one for the neon. If this chip is malfunctioning it may be distorting one of the outputs, causing your display to scramble.

Try swapping the microprocessor U2 on the main board. This chip controls the entire game and could be being to fail.

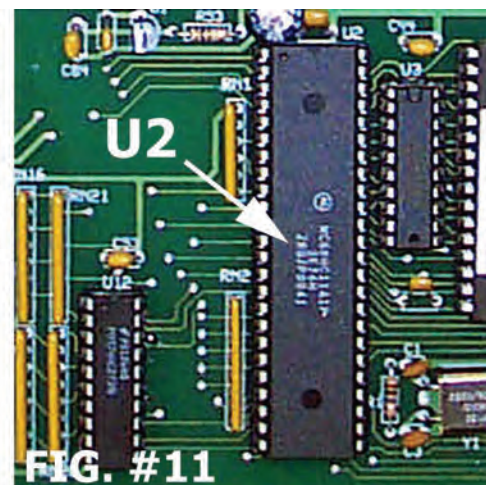
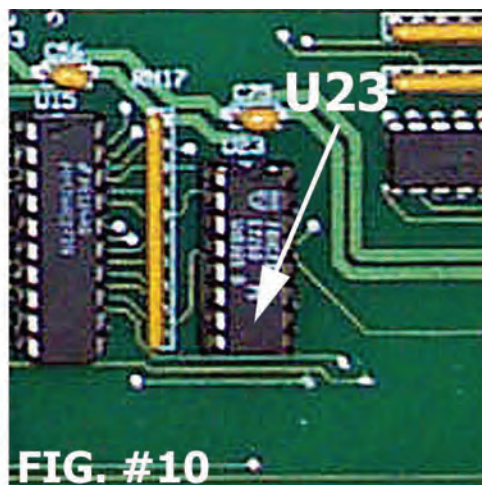
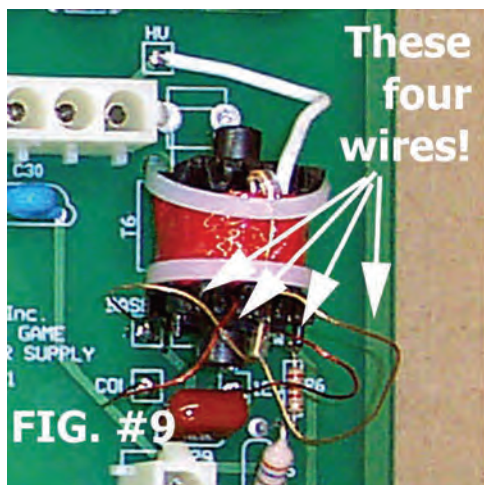

Cyclone Advance Technical Information

Light In Button On/Off All The Time:

Step 1: Check to make sure the bulb is good and that the harnessing/connectors are in good condition

Step 2: Check drive transistor on the main board (Q2 for blue, Q3 for pink, and Q4 for green). Replace if necessary

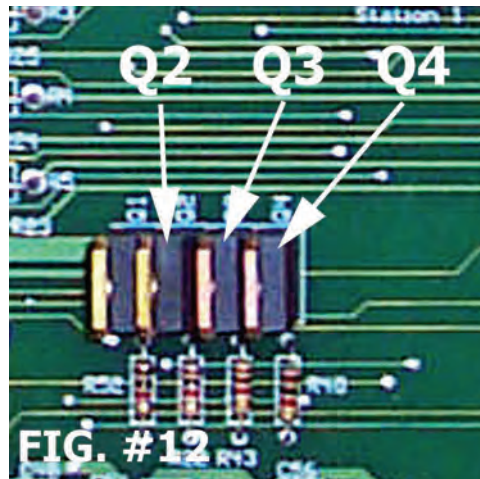

Neon(s) Are Out:

Step 1: Check fuse F2 on main board. Also verify holder is holding fuse properly.

Step 2: Check voltage on VR2, you'll be looking for 12 VDC.

Step 3: Check the harness/connectors between the neon board and the main board looking for possible exposed or broken wires.

Step 4: Try swapping with a known working neon bulb to see if bulb is bad or the output to that bulb is bad.

Step 5: Replace neon transformer, 2 transistors, capacitor, and inductor (all parts available in neon repair Kit CC2020RX and will repair only one neon circuit on the neon controller board).

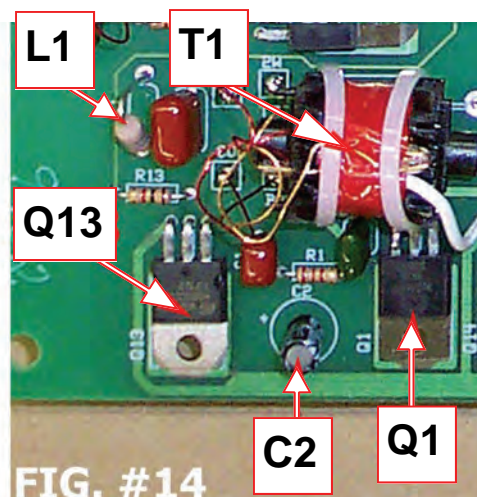
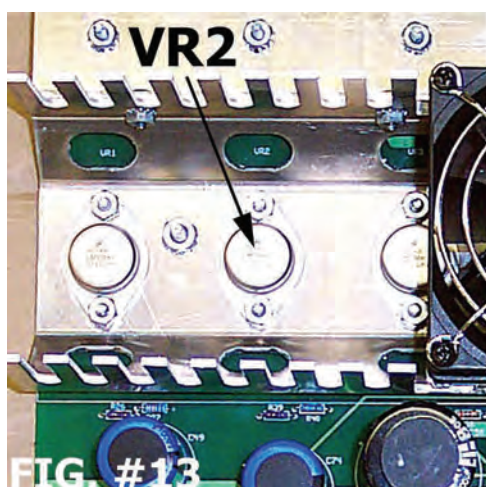

Cyclone Advance Technical Information

Game Not Saving Programming Options:

Step 1: Check battery on main board, verify it has 3.2 VDC. If not replace it

Step 2: Check D2 on main board, if this diode is open in both directions or shorted in both directions, then replace it.

Step 3: Replace U2.

Fan On Main Board Dead:

Step 1: Check voltage to fan. This should be 12 VDC. That voltage also powers the neon controller board.

Step 2: Replace fan. Note - if game is run without a properly running main board fan, the voltage regulators and bridge rectifiers on the main board may fail from thermal breakdown.

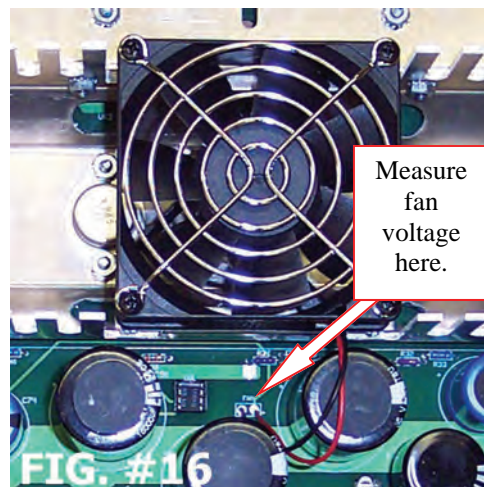
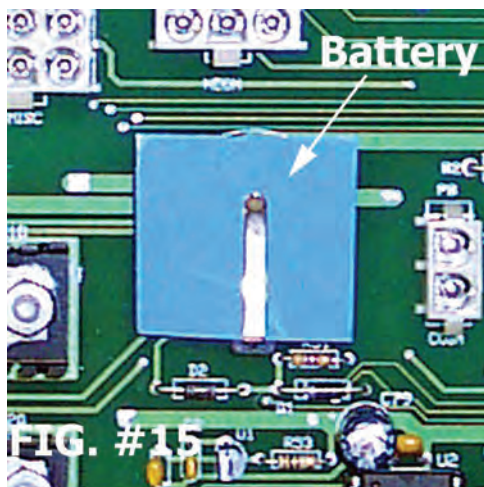

PARTS LISTINGS

Display Boards

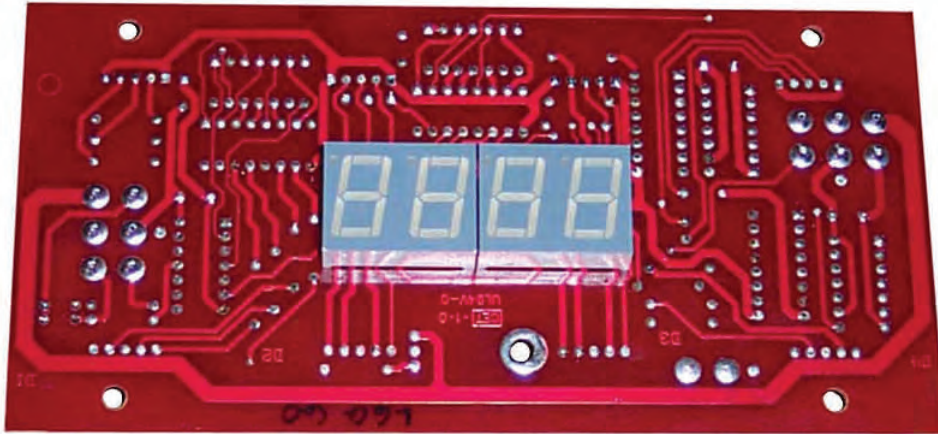

CC2032X— Tickets Owed Display PCB (front)



CC2033X— Jackpot Display PCB (front)

CC2035X Light Ring Board

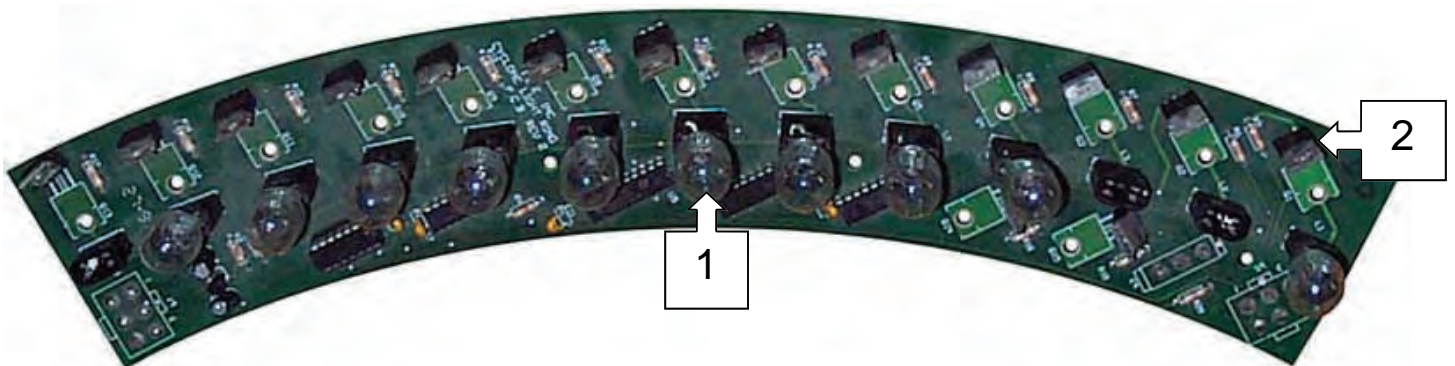

1. E02005—906 Bulb
2. E02110— Q1 through Q15, TIP 122 Transistor

PARTS LISTINGS

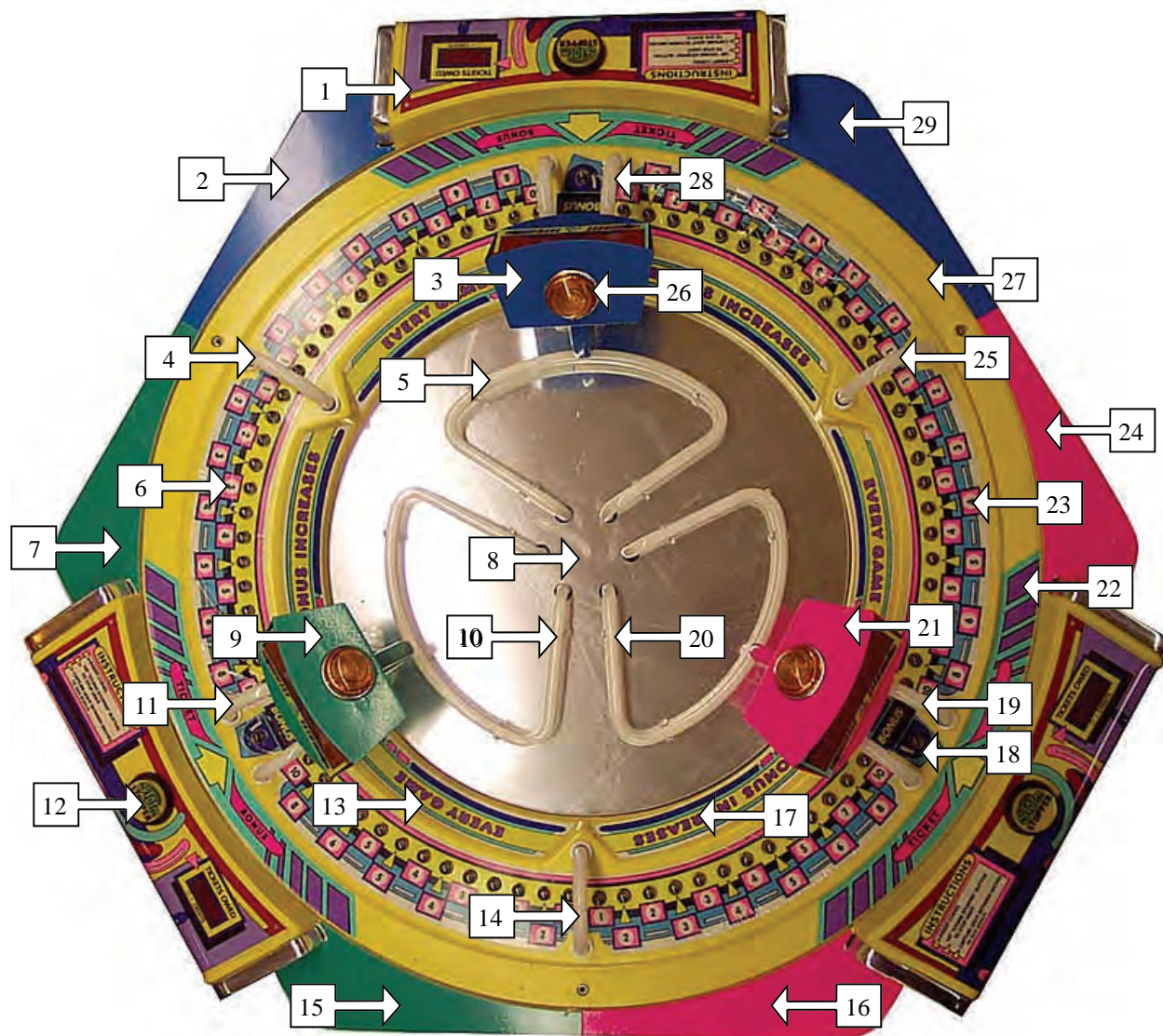

- | | |
|--|---|
| 1. CC3002X—Control Panel Assembly | 16. CC1011-P102LX—Top Panel Overlay (pink/ left) |
| 2. CC1011-P504RX—Top Panel Overlay (blue/ right) | 17. CC7010— Bonus Increases Decal |
| 3. CC1035-P504—Scoreboard Housing (blue) | 18. CC7013—Bonus Decal |
| 4. CC2020A—Neon Arch Assembly (blue) | 19. CC2018A—Neon Arch Assembly (pink) |
| 5. CC2023A—Neon Triangle Assembly (blue) | 20. CC2021A—Neon Triangle Assembly (pink) |
| 6. CC7012—Zone Decal (left) | 21. CC1035-P102—Scoreboard Housing (pink) |
| 7. CC1011-P403LX—Top Panel Overlay (green/ left) | 22. CC7003—Ticket Bonus Decal |
| 8. CC3004—Mirror | 23. CC7011—Zone Decal (right) |
| 9. CC1035-P403—Scoreboard Housing (green) | 24. CC1011-P102RX—Top Panel Overlay (pink/ right) |
| 10. CC2022A—Neon Triangle Assembly (green) | 25. CC2018A—Neon Arch Assembly (pink) |
| 11. CC2019A—Neon Arch Assembly (green) | 26. CC2016X—Jackpot Beacon Assembly |
| 12. CC7005X—Storm Stopper Button Assembly | 27. CC3003X—Playfield Assembly |
| 13. CC7015—Every Game Decal | 28. CC2020A—Neon Arch Assembly (blue) |
| 14. CC2019A—Neon Arch Assembly (green) | 29. CC1011-P504LX—Top Panel Overlay (blue/ left) |
| 15. CC1011-P403RX—Top Panel Overlay (green/ right) | |

PARTS LISTINGS

Neon Controller PCB

(this board is advance replaceable)

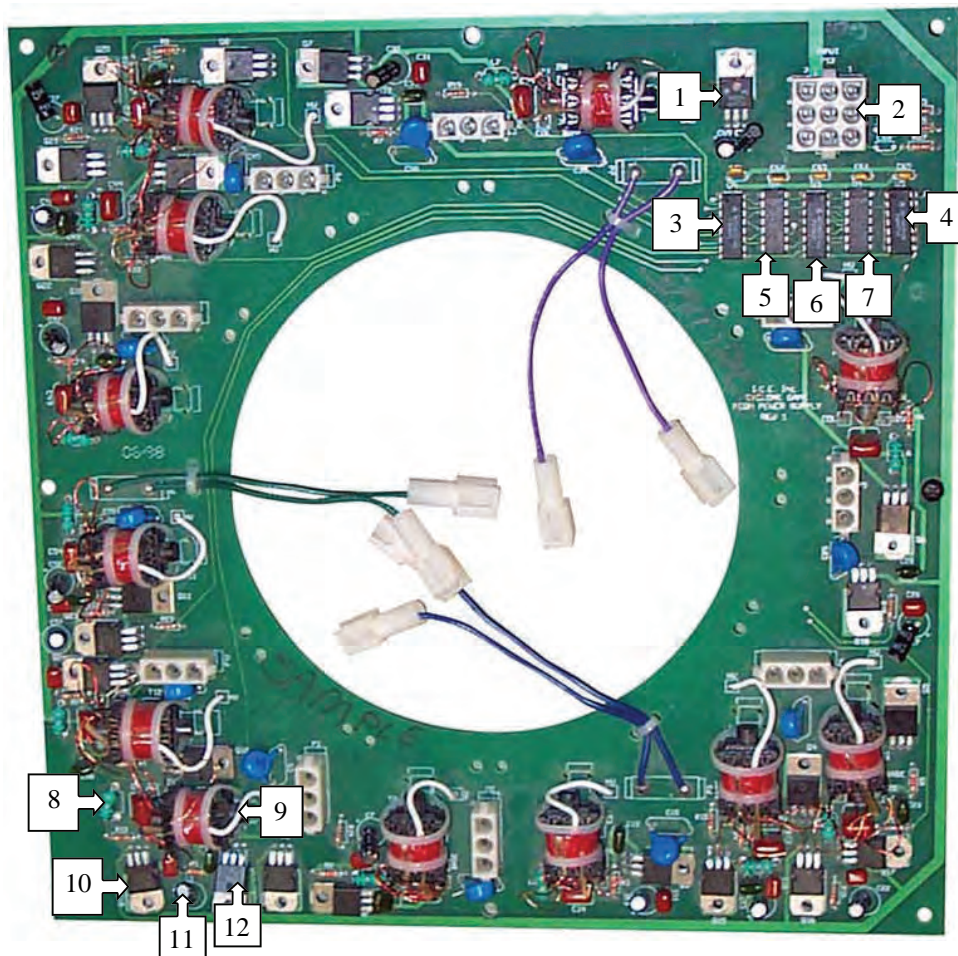

(ICE's part numbers in parenthesis)

1. VR1— MC7805CTG voltage regulator (E20435)
2. P13 Connection to Main PCB
3. U4— IC 74HC174 (E02262)
4. U5—IC 74HC14 (E02117)
5. U2—IC 74HC165 (E02301)
6. U3—IC 74HC174 (E02262)
7. U1— IC 74HC165 (E02301)
8. Inductor L1 through L12— 3.6uH 1.5amp (E00050)*
9. Transformer T1 through T12— Neon Transformer (CC2001)*
10. Transistor Q13 through Q24—TIP122 (E02110)*
11. Capacitor c2, c7, 12, c17, c22, c27, c32, c37, c42, c47, c52, c57—10uf 50V Electrolytic (E02325)*
12. Transistor Q1 through Q12— MJE3055T NPN (E02532)*

* All of these parts are available in a repair kit (CC2020RX). One of these repairs kits will repair one neon driver circuit (i.e. if the neon connected to connector P1, you would replace L1, T1, Q1, Q13, and C2).

PARTS LISTINGS

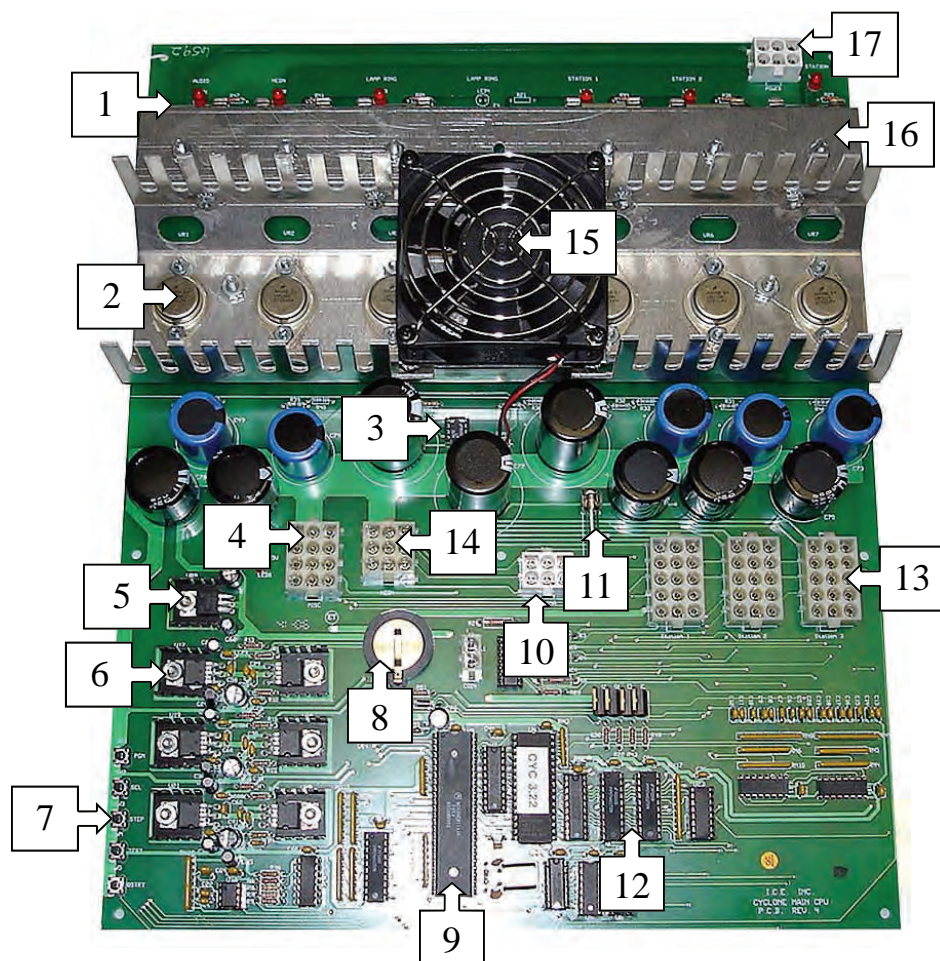

CC2034X Main Board Connectors & Components
 (part numbers in parentheses, and this board is advance replaceable)

- | | |
|--|---|
| <ol style="list-style-type: none"> 1. Fuses (all are slow blow)—F1 3 Amp 250 Volt(E02315), F2 6 Amp 250 Volt (E02295), F3 10 Amp 32 Volt (E02259), F5 + F6 + F7 3 Amp 250 Volt (E02315) 2. Voltage Regulators—VR1-VR7 LM338k (E20809) 3. U8— LM307N Op Amp (2523) 4. P5 Misc. Connector 5. Voltage Regulator—LM358N 5vdc (E02124) 6. Audio Amps— U17-U22 TDA2003H Amp (E02254) | <ol style="list-style-type: none"> 7. Program Buttons 8. Battery— 3.2v Lithium (E20407) 9. U2 Microprocessor— MC68HC11A1P (2368) 10. P6 Light Ring Connector 11. Fuse—F8 10 Amp 32 Volt (E02259) 12. U13 & U15— 74HC273 (E02305) 13. P2, P3, P4 Station Connectors 14. P7 Neon Connections 15. Fan—12vdc (E02364) 16. Diode Bridge— 35 Amp (E02444) 17. P1 Power Connector |
|--|---|

PARTS LISTINGS

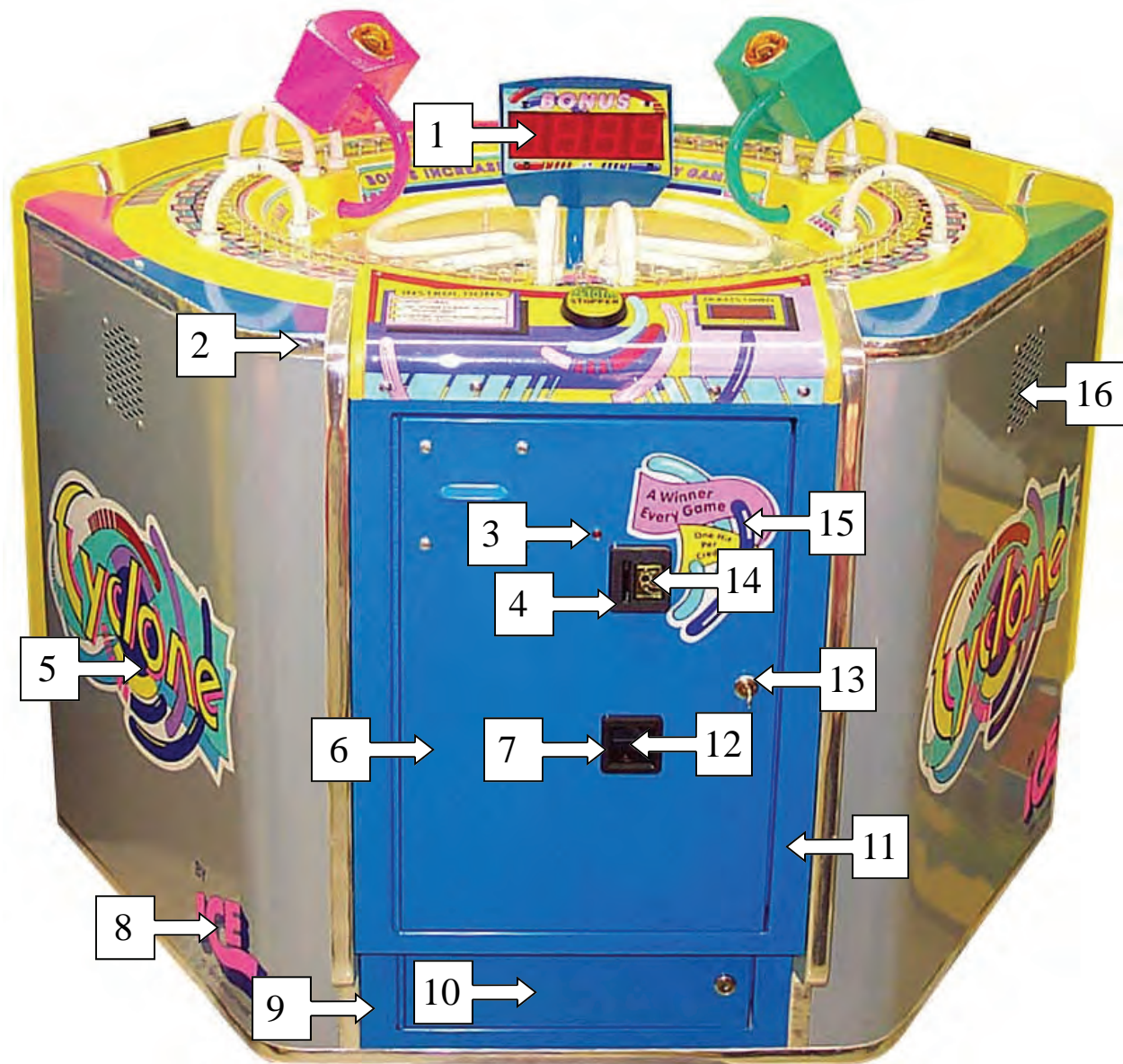

- | | |
|--|--|
| 1. CC7006—Scoreboard Overlay | 10. CC1032-P504—Cash Box Door (blue) |
| 2. 201—Chrome T-molding | A. CC1032-P403—Cash Box Door (green) |
| 3. E01017—LED Holder | B. CC1032-P102—Cash Box Door (pink) |
| 4. 5101C—Entry Bezel | 11. CC1022-P504—Coin Door Frame (blue) |
| 5. CC7001—Cyclone (decal) | A. CC1022-P403—Coin Door Frame (green) |
| 6. CC1028-P504—Coin Door (blue) | B. CC1022-P102—Coin Door Frame (pink) |
| A. CC1028-P403—Coin Door (green) | 12. 5101B—Return Bezel Door |
| B. CC1028-P102—Coin Door (pink) | 13. 5014—Lock |
| 7. 5101D—Return Bezel | 14. 5101A—Reject Button |
| 8. CC7002—By ICE (decal) | 15. CC7008—Coin Door Winner (decal) |
| 9. CC1025-P504—Cash Door Frame (blue) | 16. FP2007—Speaker (not shown) |
| A. CC1025-P403—Cash Door Frame (green) | |
| B. CC1025-P102—Cash Door Frame (pink) | |

PARTS LISTINGS

MECHANICAL PARTS

CC1001	CABINET SPEAKER PANEL
CC1007	MAIN P.C. BOARD MOUNTING BRACKET
CC1008	CASH BOX ENCLOSURE
CC1009	POWER MODULE MOUNTING PLATE
CC1011	TOP PANEL OVERLAY (BLUE, L/R)
CC1014	TOP PANEL OVERLAY (PINK, L/R)
CC1017	TOP PANEL OVERLAY (GREEN, L/R)
CC1019	SCOREBOARD MOUNTING BRACKET
CC1021	COIN FUNNEL MOUNTING BRACKET
CC1022	CABINET DOOR FRAME (BLUE)
CC1023	CABINET DOOR FRAME (PINK)
CC1024	CABINET DOOR FRAME (GREEN)
CC1025	CASH DOOR FRAME (BLUE)
CC1026	CASH DOOR FRAME (PINK)
CC1027	CASH DOOR FRAME (GREEN)
CC1028	CABINET COIN DOOR (BLUE)
CC1029	CABINET COIN DOOR (PINK)
CC1030	CABINET COIN DOOR (GREEN)
CC1032	CASH BOX DOOR (BLUE)
CC1033	CASH BOX DOOR (PINK)
CC1034	CASH BOX DOOR (GREEN)
CC1035	SCOREBOARD HOUSING (BLUE)
CC1036	SCOREBOARD HOUSING (PINK)
CC1037	SCOREBOARD HOUSING (GREEN)
CC3001X	DOME
CC3002	CONTROL PANEL (YELLOW)
CC3003	PLAYFIELD
CC3004	MIRROR
CC3005	MIRROR BACK (MELAMINE)
CC3007	POWER MODULE ENCLOSURE
CC3010	CABINET BOTTOM PLATE (MELAMINE)
CC3011	CABINET TOP PLATE (MELAMINE)
CC3012	PLASTIC CASH BOX
CC3013	COIN FUNNEL
CC3014	CABINET VERTICAL MEMBER
CC3015	TOP PLATE SUPPORT

ELECTRICAL / ELECTRONIC PARTS CON'TD.

2110	TRANSISTOR, TIP 120
2117	IC 74HC14
2124	IC LM358
2237	IC 74HC4066 BILATERAL SWITCH
2250	IC 74HC138
2253	IC 74HC374
2254	IC AUDIO AMPLIFIER TDA2003H
2262	IC 74HC174
2266	IC 74HC237 LATCHING OUTPUT DECODER
2297	IC 74HC00
2299	IC 74HC373
2301	IC 74HC165
2305	IC 74HC273
2320	GAME PROGRAM E-PROM
2364	HEAT SINK FAN
2368	IC MC68HC11A1P MICROPROCESSOR
2411	IC LM78L05ACZ 5% V
2417	IC 74HC164
2444	BRIDGE RECTIFIER 35 AMP (WIRE LEADS)
2519	6800uf CAPACITOR 25V RADIAL
2520	6800uf CAPACITOR 35V RADIAL
2521	15000uf CAPACITOR 35V RADIAL
208004	IC ULN2003A DRIVER
208009	IC LM338K VOLTAGE REGULATOR
276	DISPLAY DUR14A2.5"
2518	DISPLAY SNGL LED DUR46A 1.8"
2523	IC CA3193E HARRIS
PC20224	COUNTER 12 VOLT
PC20407	BATTERY - 3.2 VOLT (BR2032)
PC20435	IC LM340T-5 (7805) VOLTAGE REGULATOR
CC2005X	JACKPOT P.C. BOARD
CC2020X	NEON TRANSFORMER P.C. BOARD
CC2032X	TICKETS OWED (CONTROL PANEL) P.C. BOARD
CC2033X	JACKPOT DISPLAY P.C. BOARD
CC2034X	MAIN P.C. BOARD

ELECTRICAL / ELECTRONIC PARTS

CC2001	TRANSFORMER, NEON
CC2002	TRANSFORMER, GAME
CC2005	BUTTON LARGE ROUND YELLOW
CC2006	JACKPOT LIGHT (HOUSING & AMBER COVER)
CC2007	INDUCTOR 3.6 uH 1.5 AMP NEON CHOKE
CC2008	MAIN P.C. BOARD HEAT SINK
CC2016	NEON ARCH SOCKET NUT (PLASTIC)
CC2017	NEON ARCH SOCKET
CC2018	NEON ARCH (PINK)
CC2019	NEON ARCH (GREEN)
CC2020	NEON ARCH (BLUE)
CC2021	NEON TRIANGLE (PINK)
CC2022	NEON TRIANGLE (GREEN)
CC2023	NEON TRIANGLE (BLUE)
CC2335	RING BOARD BULB SOCKET
2005	LIGHT RING BULB (PLAYFIELD) #906
2061	JACKPOT LIGHT BULB #81

HARDWARE & MISCELLANEOUS

5014	COIN DOOR LOCK
PC60615A	#2 SQUARE DRIVE BIT
FP1004	LEG LEVELER MOUNTING BRACKET
FP1019	LEVELER FEET
FP2007	SPEAKER
CC2027	POWER CORD

GRAPHICS

CC7001	CYCLONE - CABINET DETAIL
CC7002	BY I.C.E. DECAL
CC7004	CONTROL PANEL OVERLAY
CC7005	STORM STOPPER - BUTTON DECAL
CC7006	SCOREBOARD OVERLAY
CC7007	PROGRAMMING DECAL
CC7008	COIN DOOR WINNER DECAL
CC7009	FUSE RATING / POWER DISCONNECT WARNING
CC7011	PLAYFIELD ZONE DECAL - RIGHT
CC7012	PLAYFIELD ZONE DECAL - LEFT
CC7013	PLAYFIELD JACKPOT DECAL
CC7014	ALTERNATE ZONE NUMBER DECAL SHEET
CC9001	SERVICE MANUAL

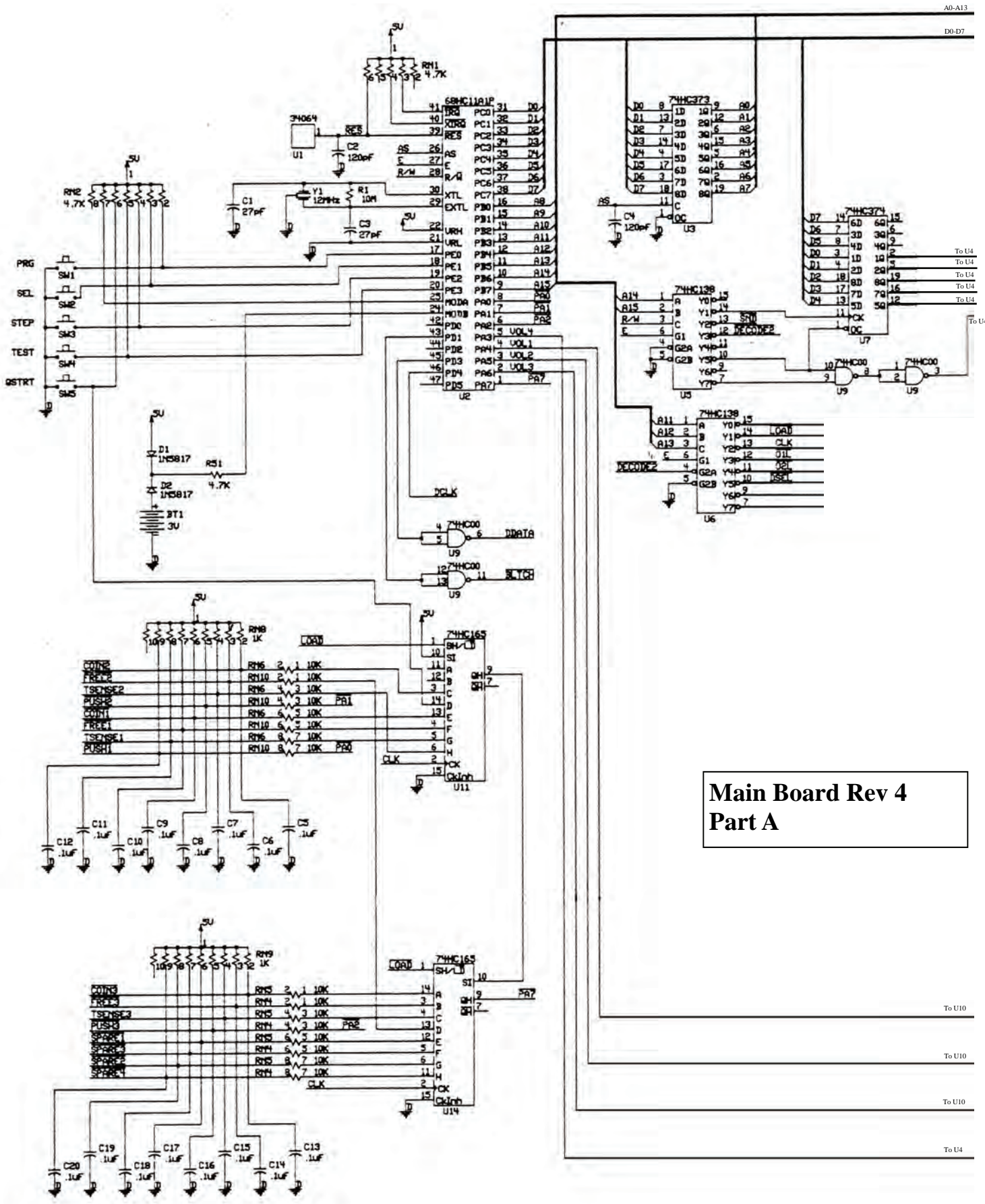

Main Board Rev 4
Part A

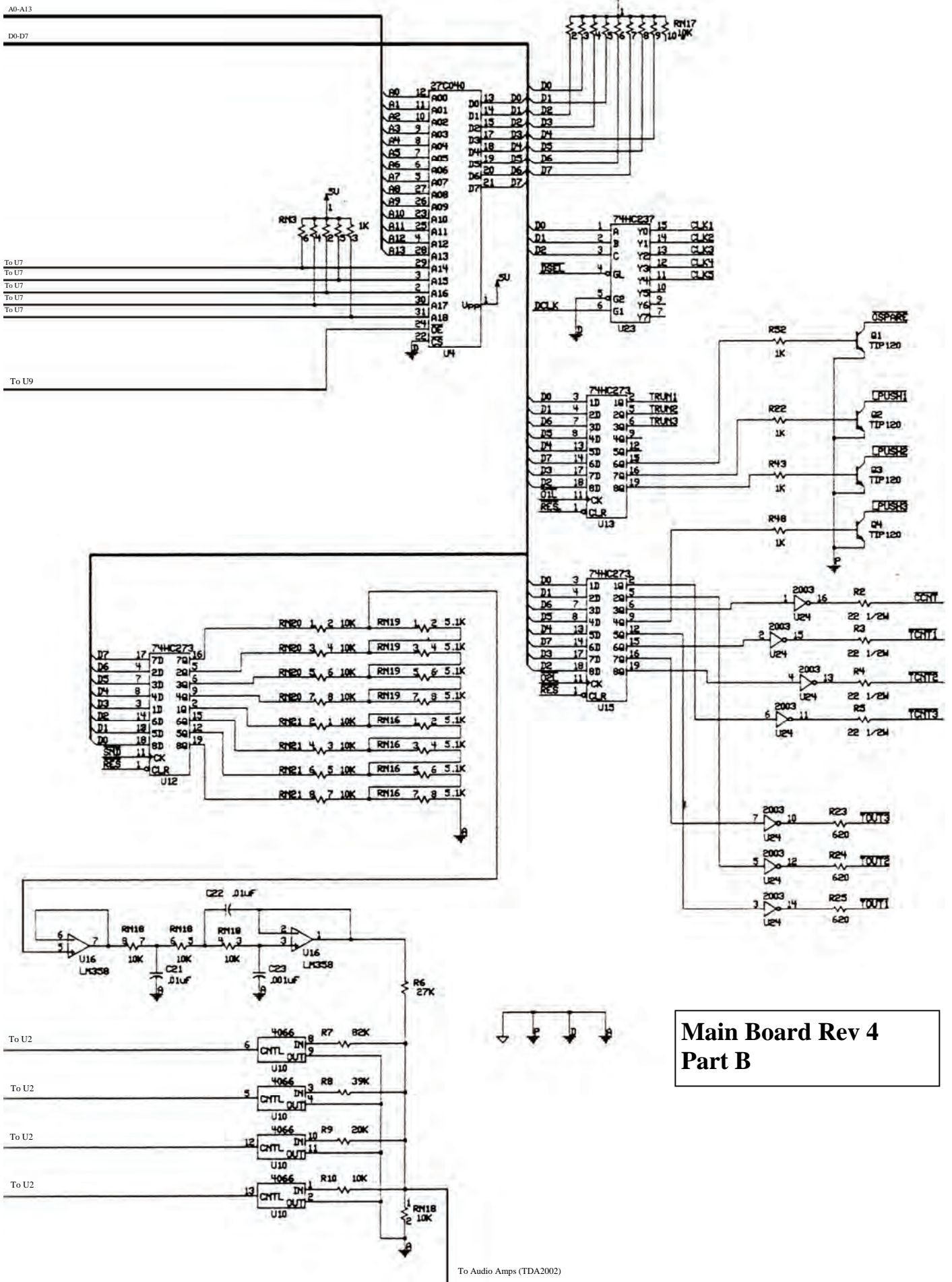

**Main Board Rev 4
Part B**

To Audio Amps (TDA2002)

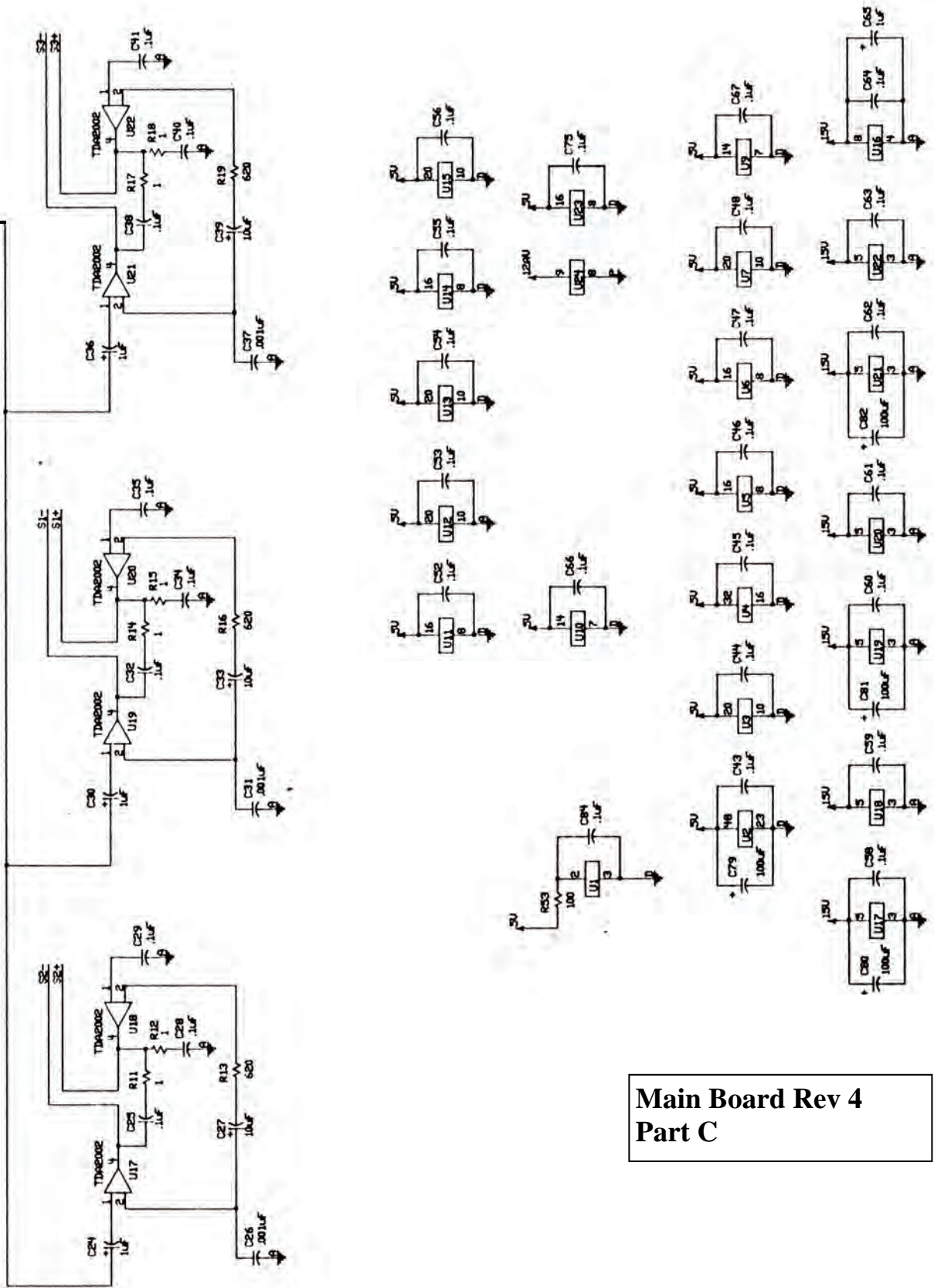

**Main Board Rev 4
Part C**

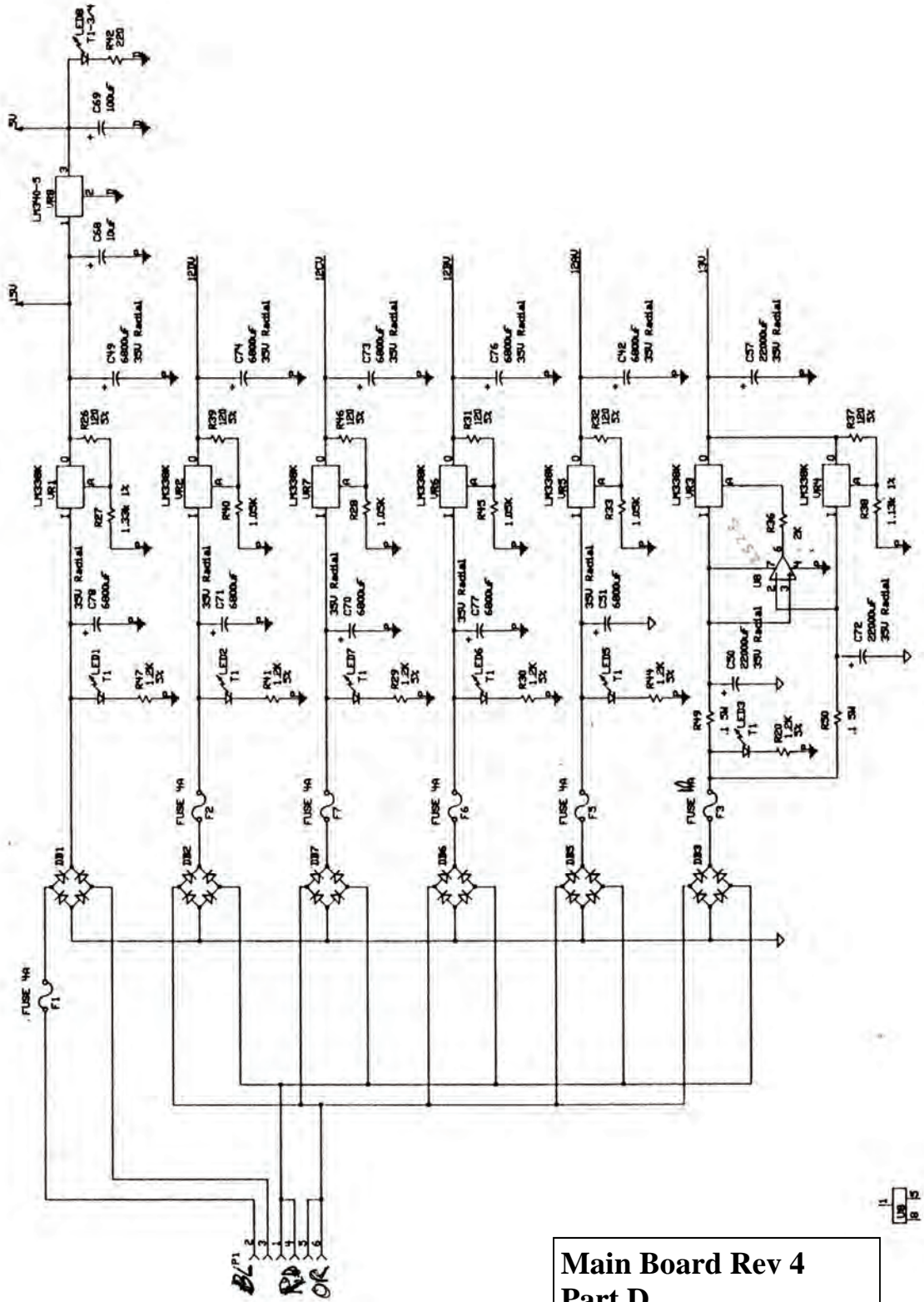

Main Board Rev 4
Part D

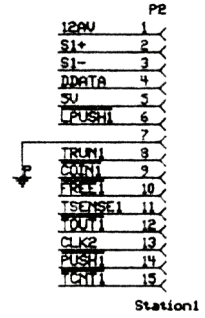

B

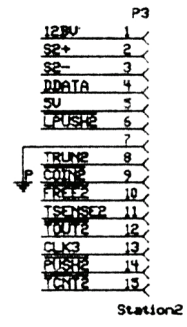
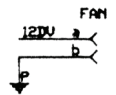

P

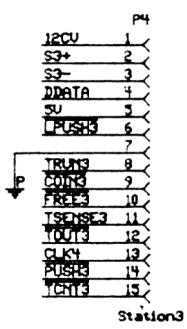
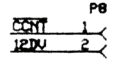

G

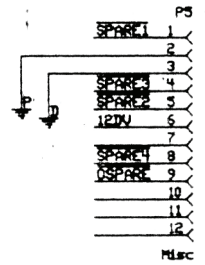
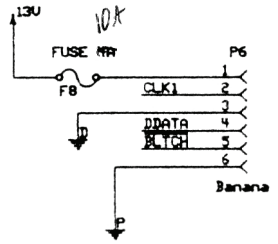
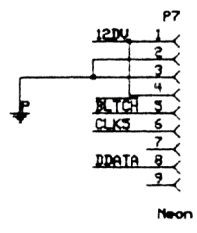

Main Board Rev 4
Part E

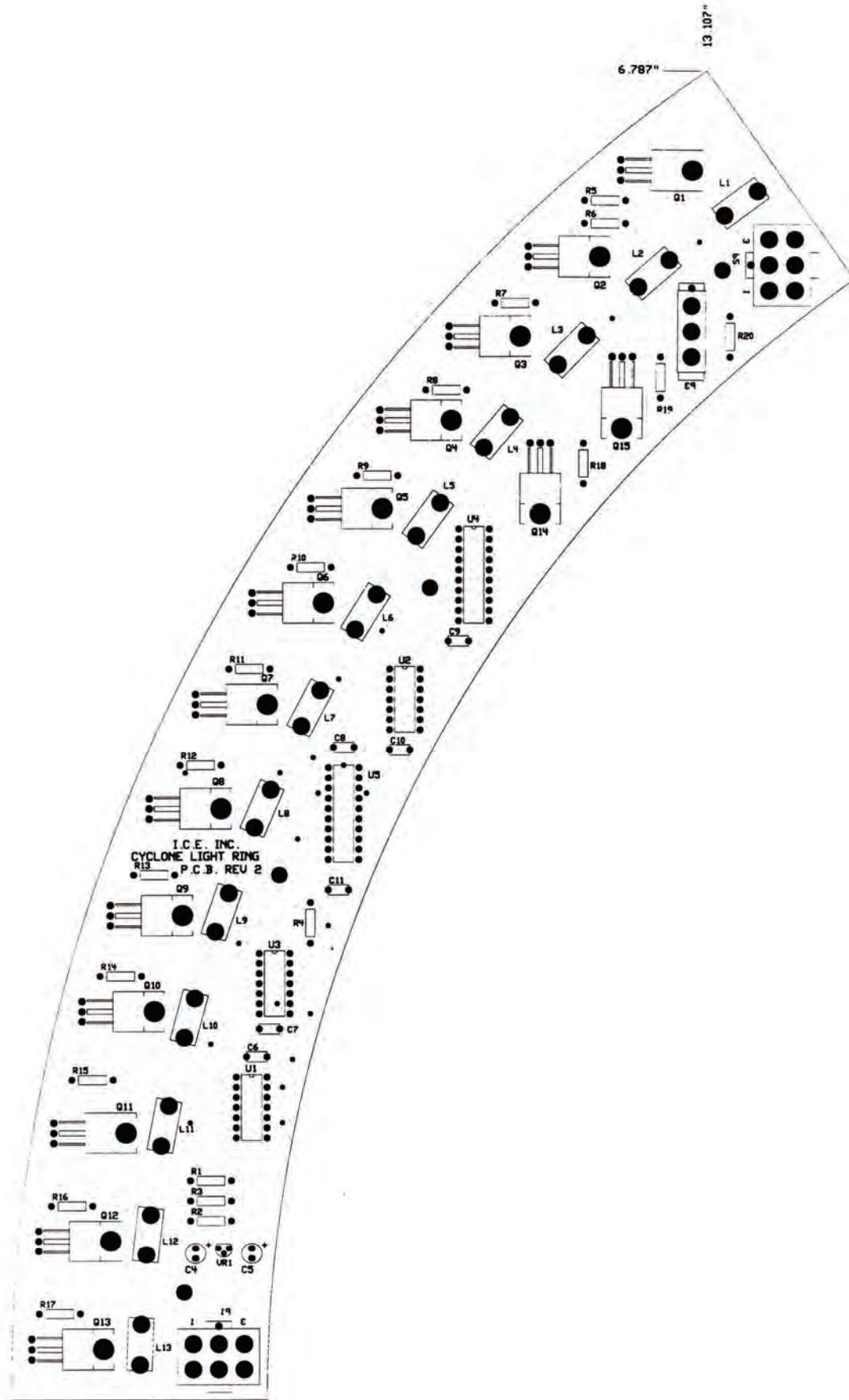

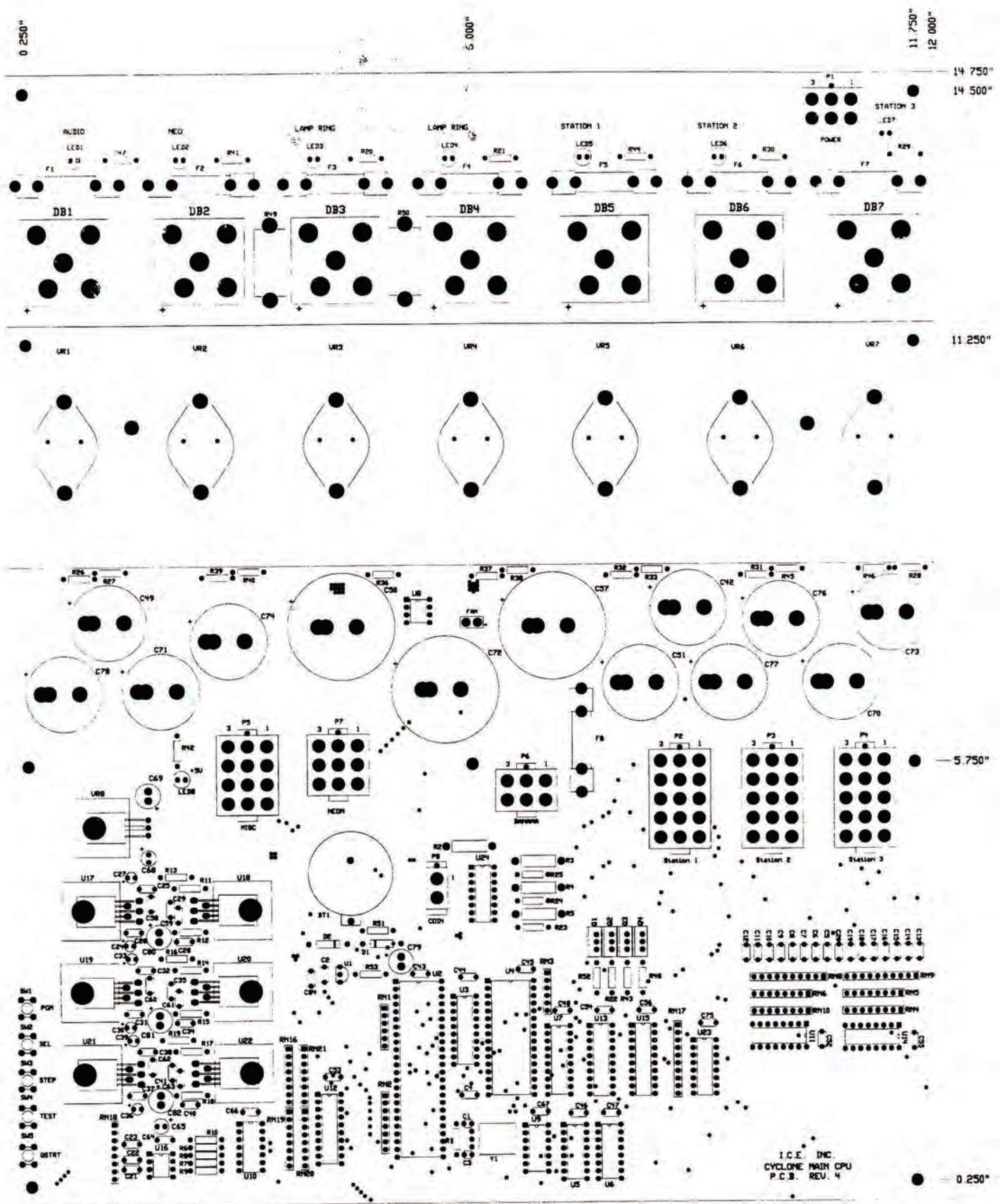

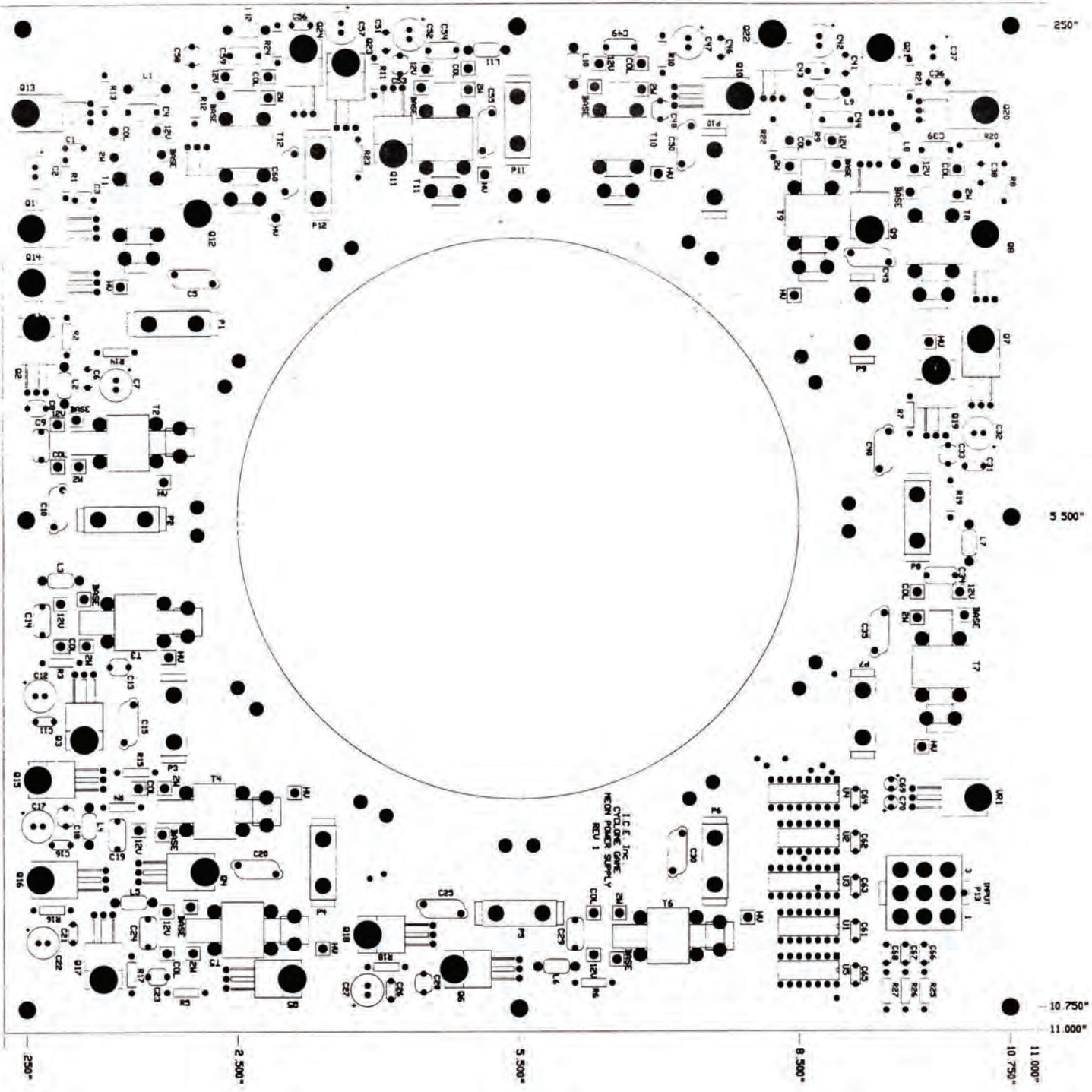

250

5.500"

10.750"

11.000"

10.750"

8.500"

5.500"

2.500"

2.500"

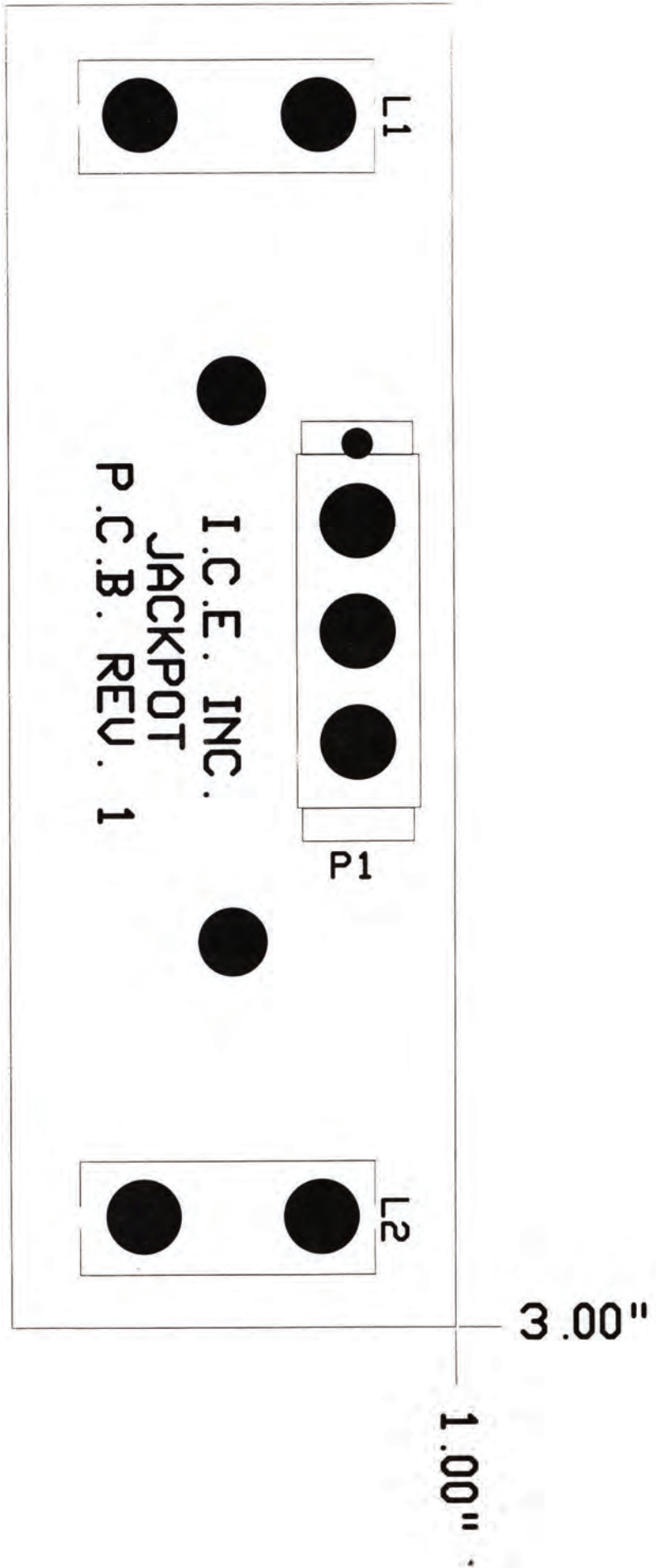

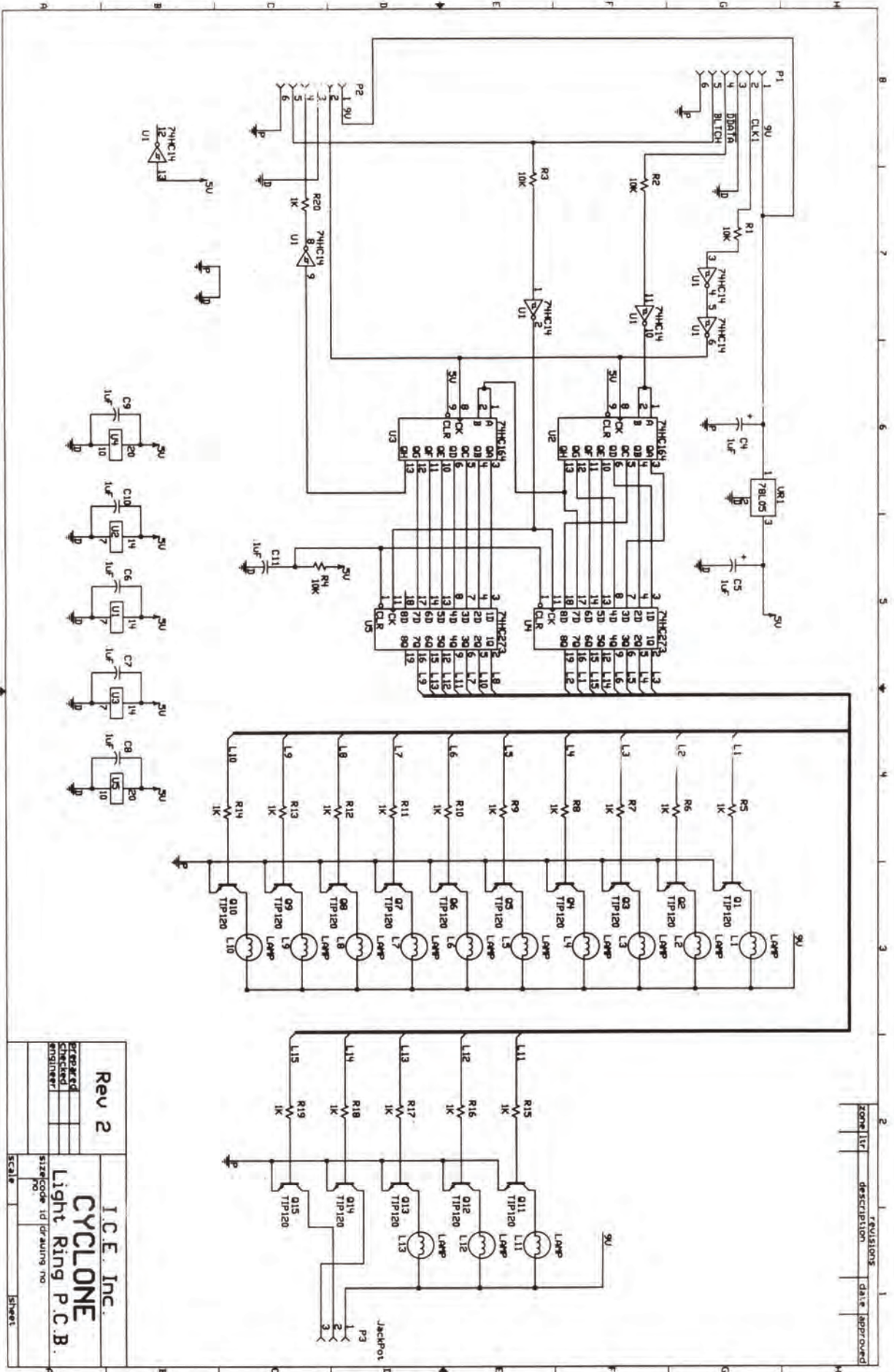

I.C.E. Inc.	
CYCLONE	
Light Ring P.C.B.	
Rev 2	Scale
Checked	Sizecode
Engineer	Id
	Drawings no
	Sheet

REV	DESCRIPTION	DATE	APPROVED
2			

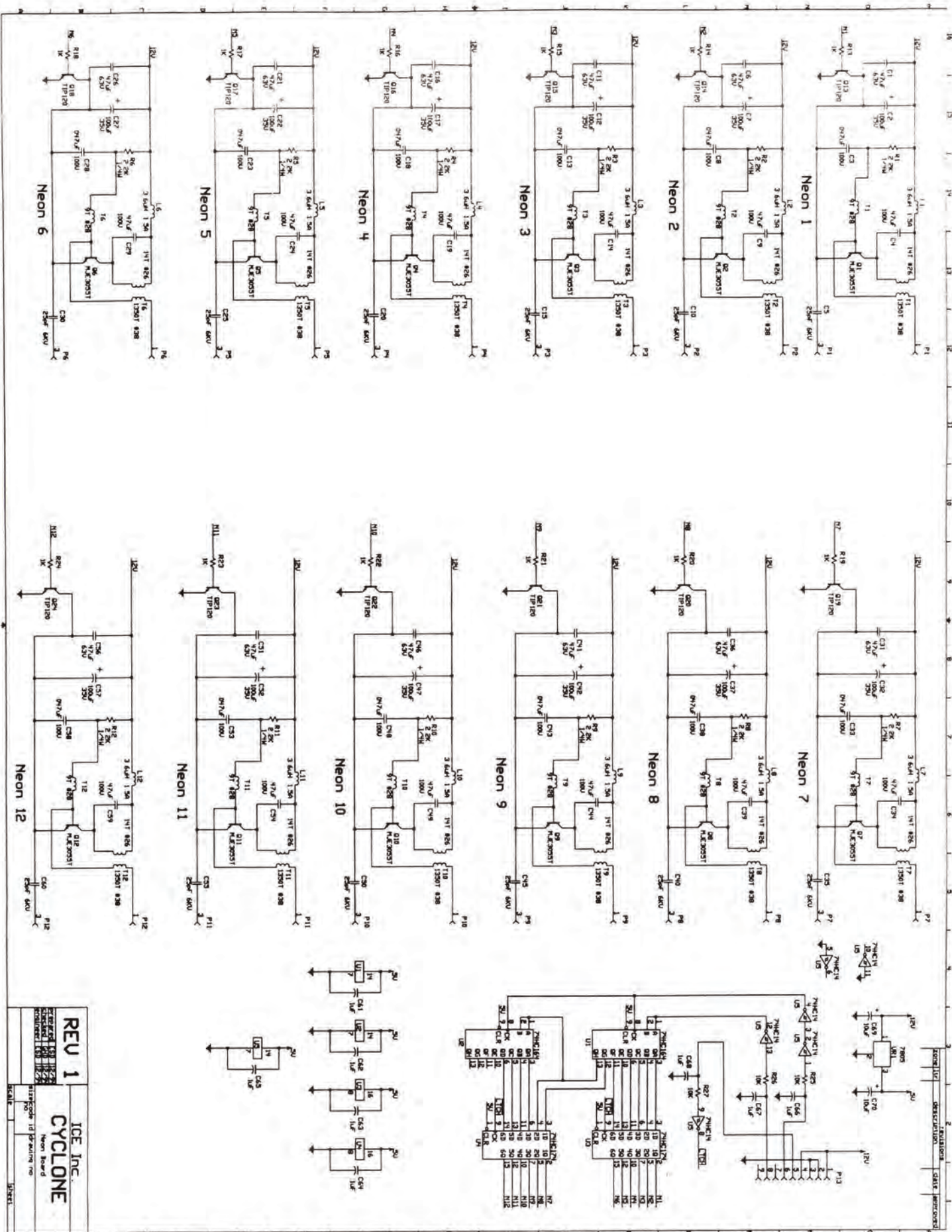

Cyclone Transformer Specifications

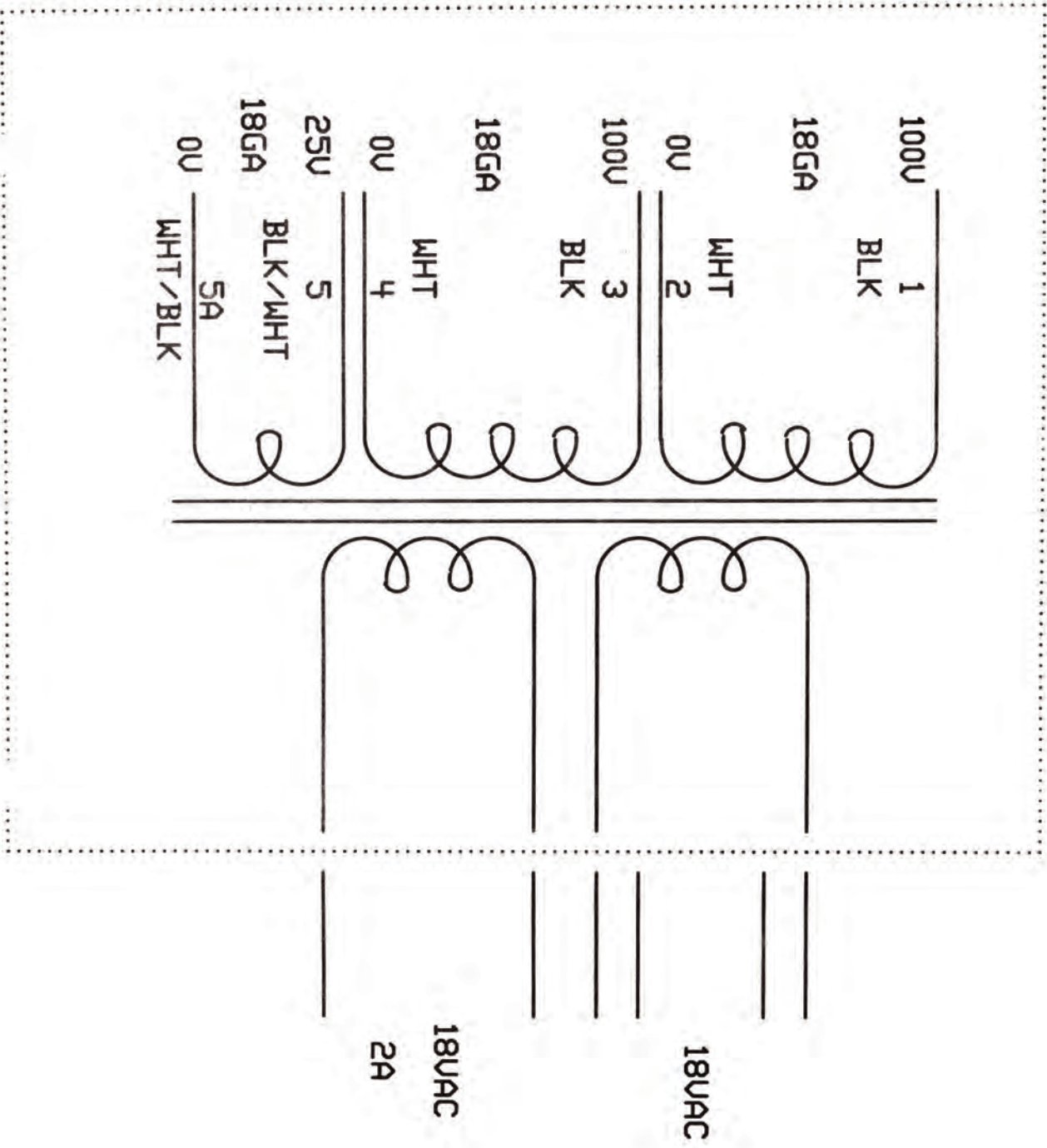

TRANSFORMER CABLE

From Transformer

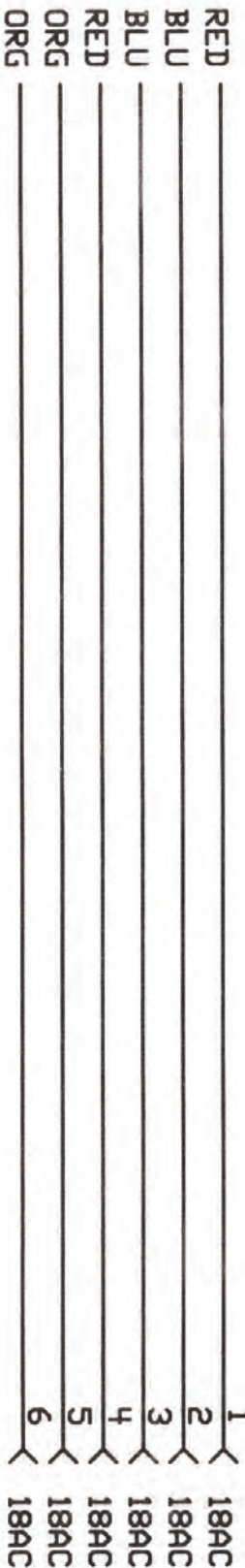

Power Connector

P1

AMP 6 PIN

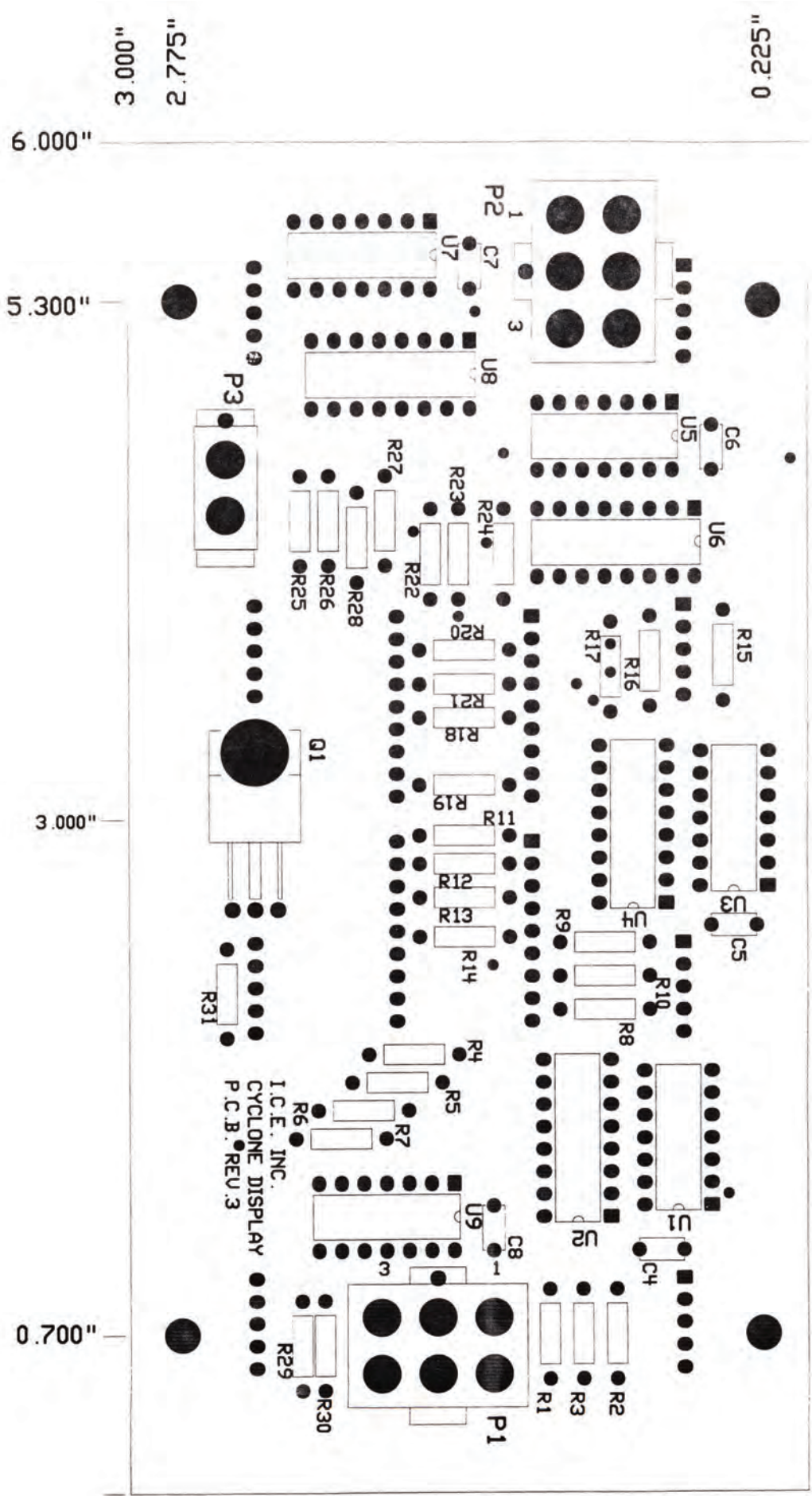

STATION CABLE

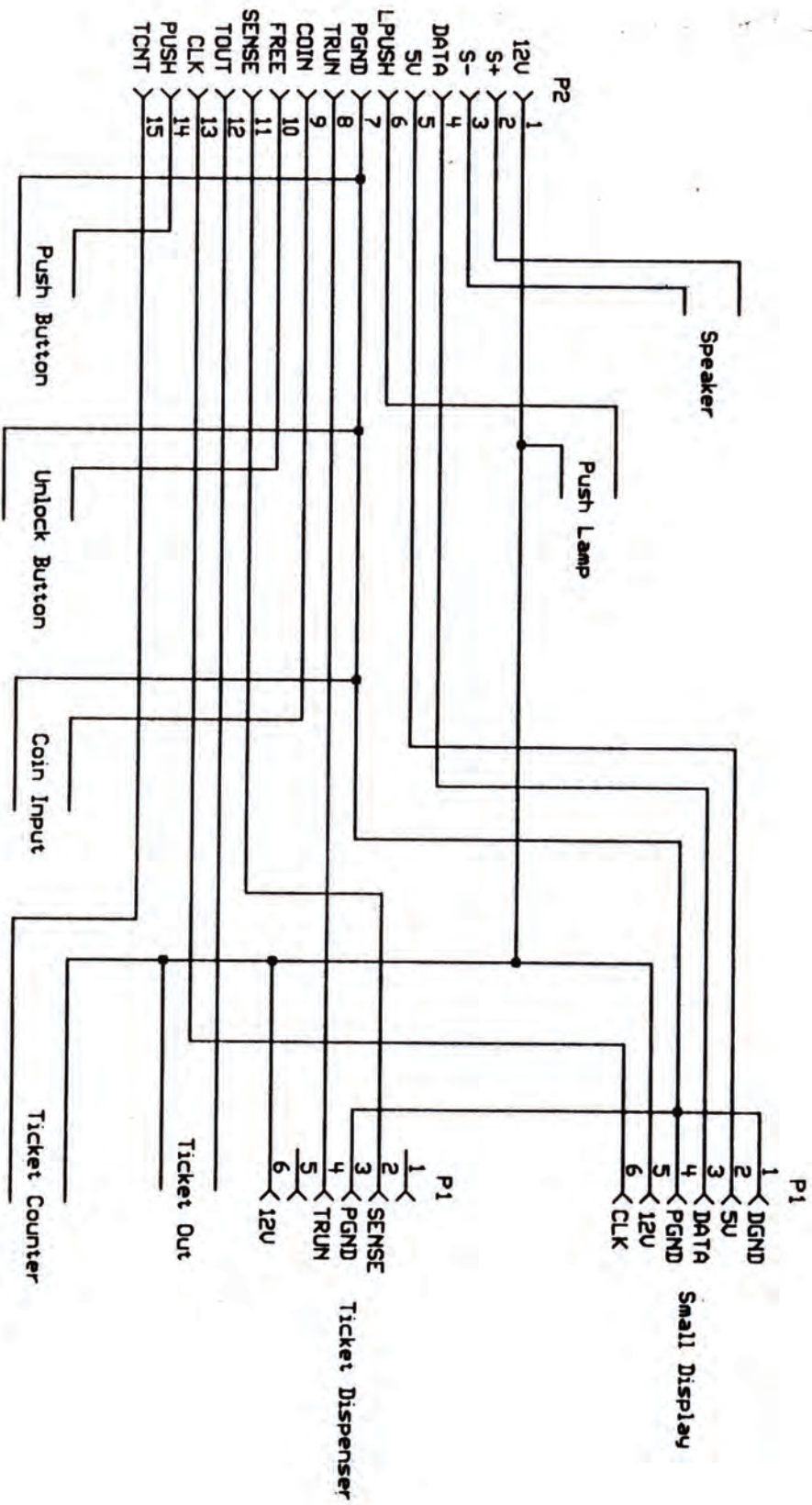

RING/CPU CABLE

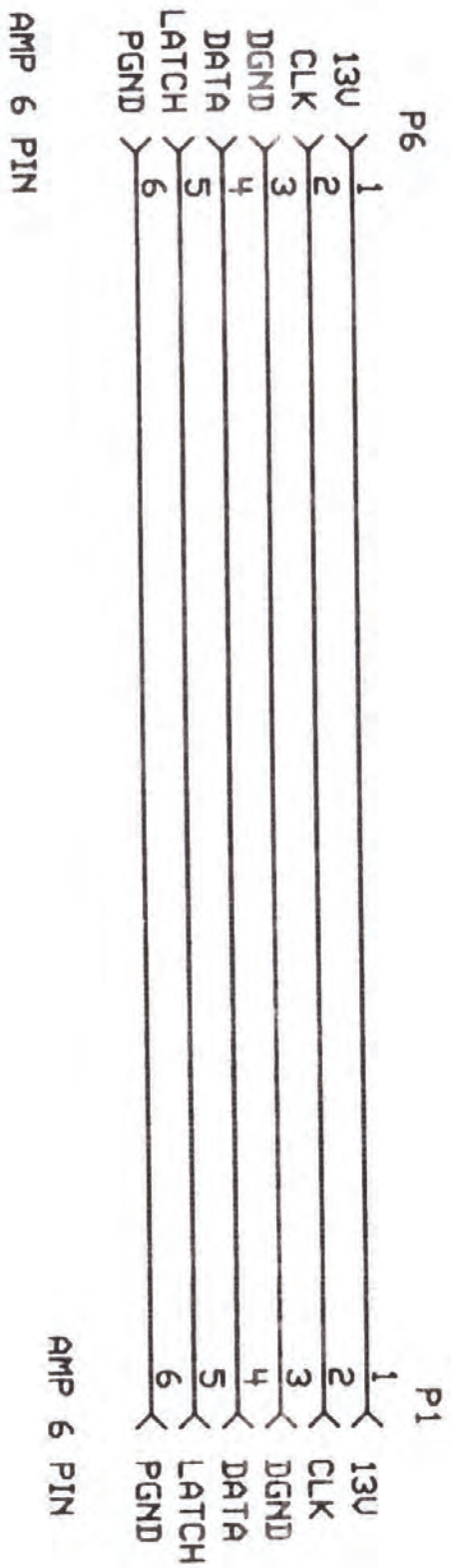

JACKPOT CABLE

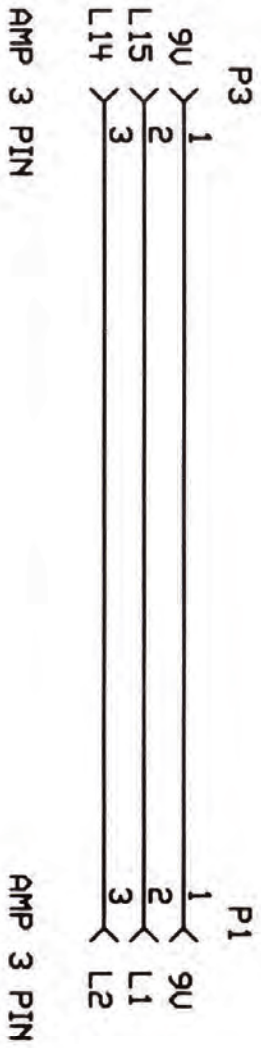

DISPLAYS INTERCONNECT

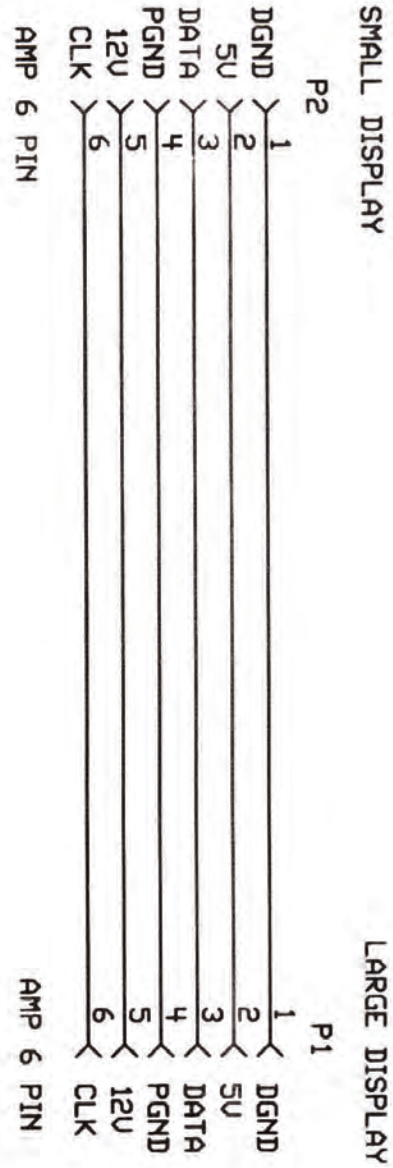

Coin Counter Harness

No Connector This End



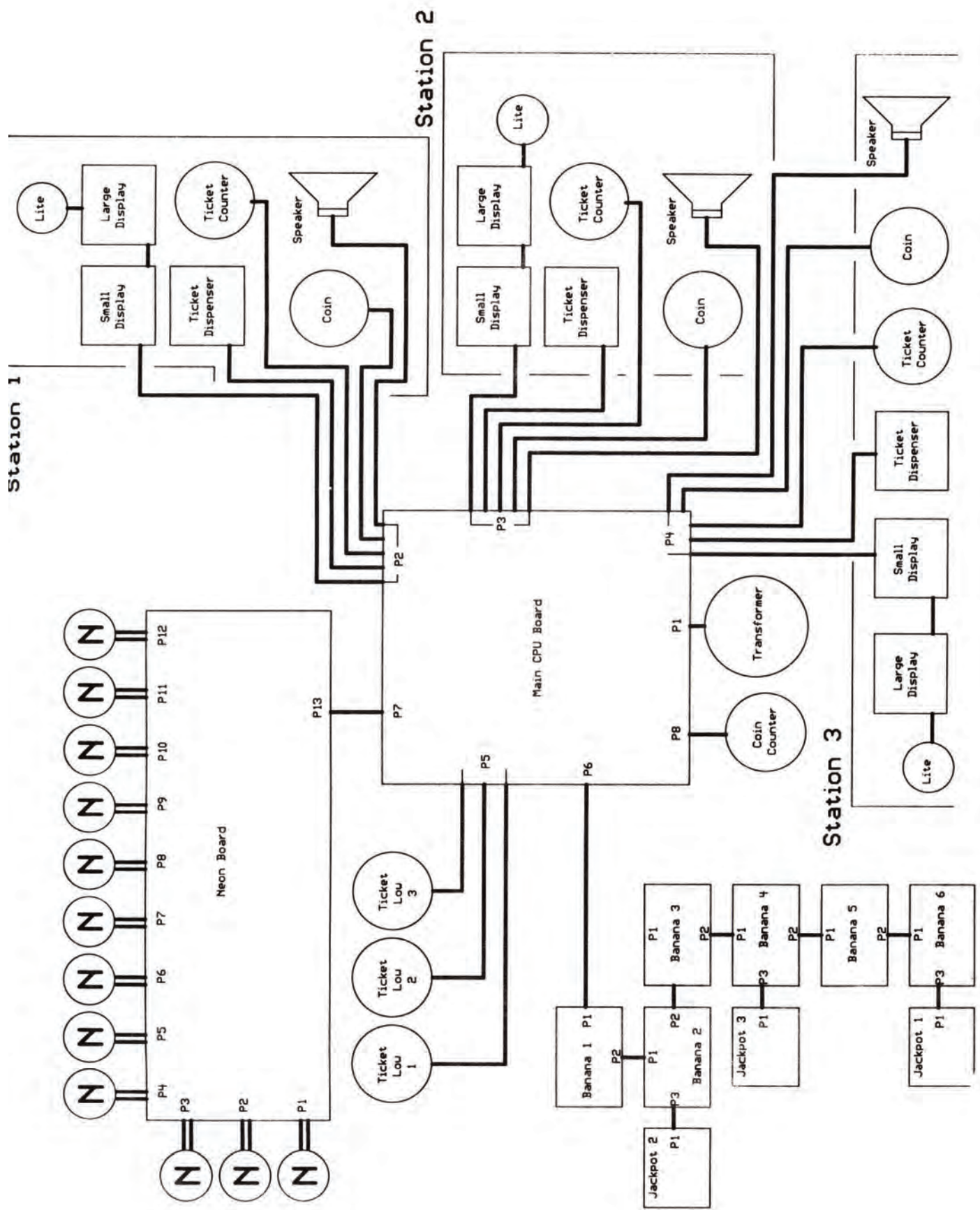

Neon Harness Cable

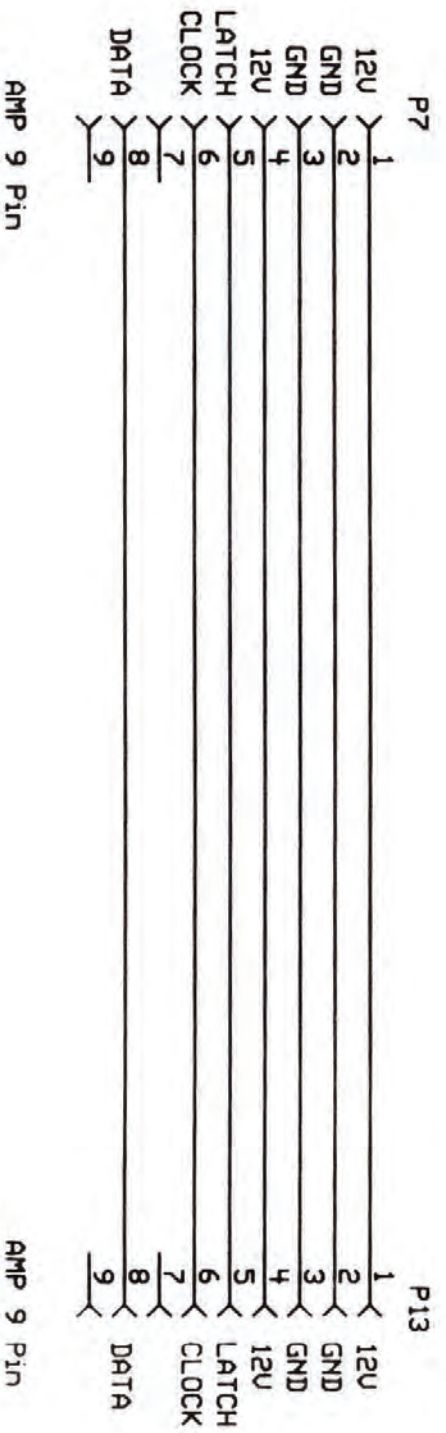

LIGHT RING INTERCONNECT

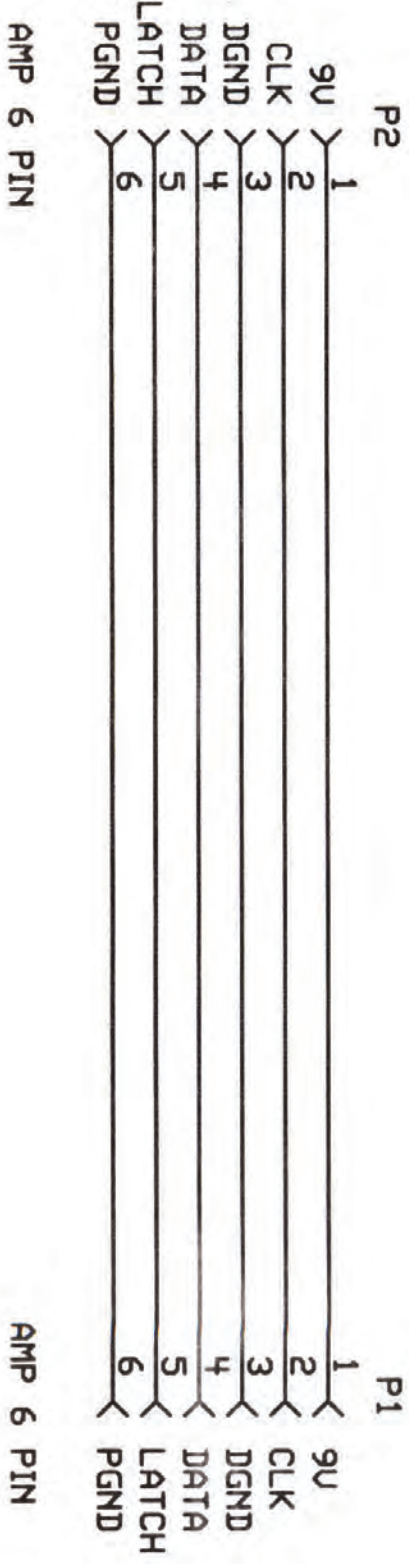

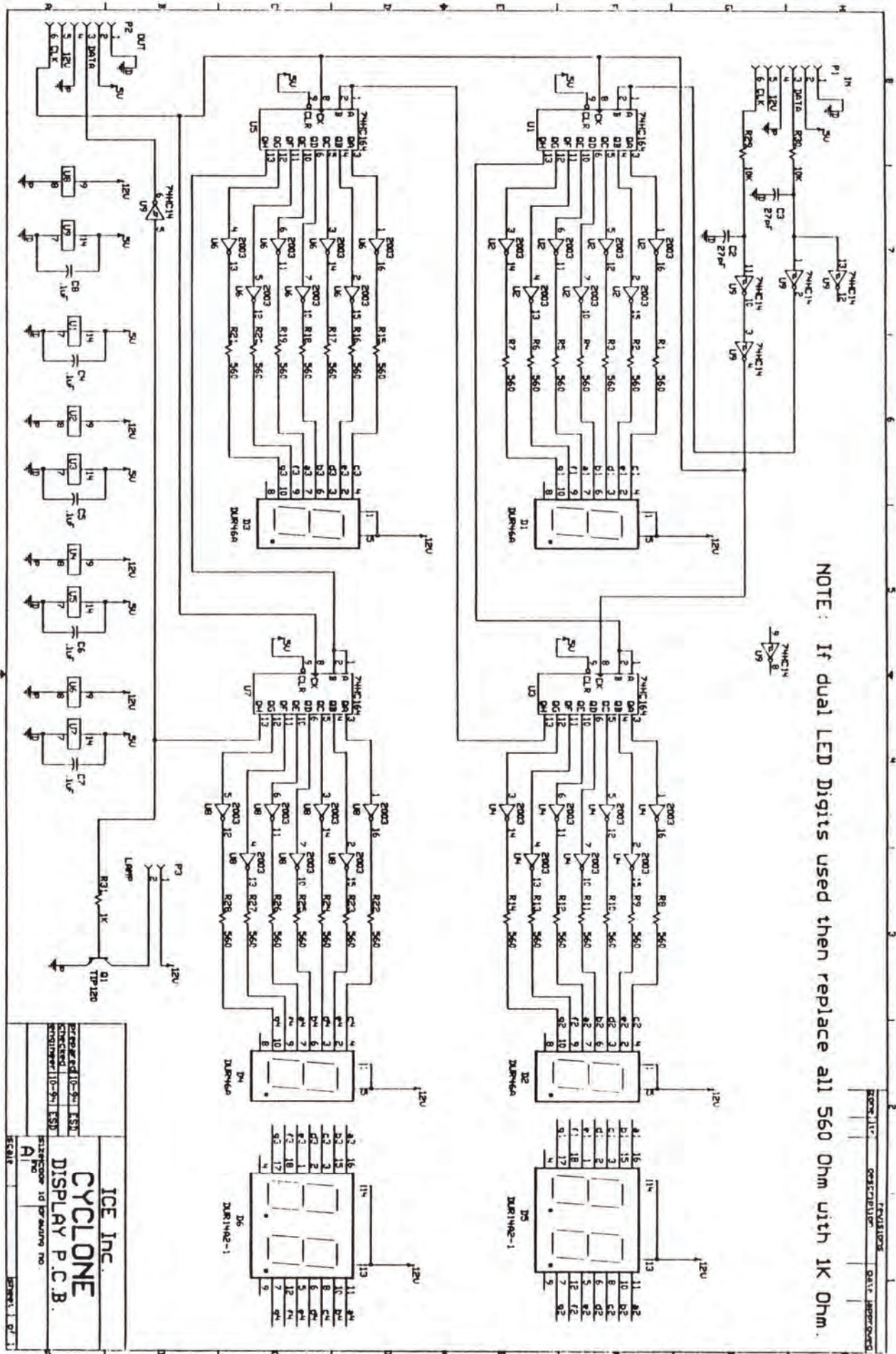

REPAIR/TEST CENTER 1000 W. 10th St. Columbus, GA 31906	ICE INC. CYCLONE DISPLAY P.C.B.
10/10/00 10/10/00	10/10/00 10/10/00

Warranty

I.C.E warrants all components in the **CYCLONE™** game to be free of defects in materials and workmanship for a period of ninety days from the date of purchase.

This warranty does not cover items damaged due to normal wear and tear, subjected to abuse, improperly assembled by the end user, modified, repaired, or operated in a fashion other than that described in the service manual.

If your **CYCLONE™** game fails to conform to the above-mentioned warranty, I.C.E.'s sole responsibility shall be at its option to repair or replace any defective component with a new or remanufactured component of equal to or greater O.E.M. specification.

I.C.E. will assume no liability whatsoever, for costs associated with labor to replace defective parts, or travel time associated therein.

I.C.E.'s obligation will be to ship free of charge, replacement parts by domestic U.P.S. Ground, domestic U.S. mail, or other comparable shipping means. Any express mail, International or overnight shipping expense is at the cost of the purchaser.

Products will be covered under warranty only when:

- The serial number of the game with the defective parts is given.
- The serial number of the defective part, if applicable, is given.
- Defective parts are returned to I.C.E., shipping pre-paid, in a timely fashion, if requested by I.C.E.
- A copy of the sales receipt is available as proof of purchase upon request of I.C.E.

I.C.E. distributors are independent, privately owned and operated. In their judgment, they may sell parts or accessories other than those manufactured by I.C.E. We cannot be responsible for the quality, suitability, or safety of any non-I.C.E. part, or any modification, including labor, which is performed by such a distributor.



WARRANTY

ICE Inc warrants that all of its products will be free from defects in material and workmanship.

When placing a warranty request, please be prepared to provide the following information:

- Serial Number of Game or Bill of Sale
- Machine Type
- A Detailed Description of the Equipment Fault Symptoms

ICE product, including Cromptons, Sam's Billiards, Uniana and Bell Fruit is warranted as follows:

- 180 days on the Main PCB and Computers
- 90 days on all other components (i.e. DBV's, Ticket Dispensers, etc)
- 30 days on repaired items
- 3 years on all Crane Harnessing
- 9 Months on Printers

ICE Inc shall not be obligated to furnish a warranty request under the following conditions:

- Equipment has been subjected to unwarranted stress through abuse or neglect
- Equipment has been damaged as a result of arbitrary repair/modification attempts
- Equipment that has failed through normal wear and tear

ICE Inc will assume no liability whatsoever for costs associated with labor to replace defective parts or travel time associated therein.

All defective warranty covered components will be replaced with new or factory refurbished components equal to OEM specifications. ICE Inc will cover all domestic UPS ground, or comparable shipping means, freight costs during the warranty period. Expedited and International shipments are available for an additional charge.

Defective parts are returned to ICE Inc, at the customer's expense, in a timely fashion.

ICE distributors are independent, privately owned and operated. In their judgment, they may sell parts and/or accessories other than those manufactured by ICE Inc. We cannot be responsible for the quality, suitability or safety of any non-ICE part, modification (including labor) that is performed by such a distributor.

I.C.E. Parts/Service Dept.
Innovative Concepts in Entertainment
10123 Main St.
Clarence, NY 14031
Phone #: (716) - 759 - 0360
Fax #: (716) - 759 - 0884