



GAME OPERATION & INSTRUCTION MANUAL

FOR ALL PARTS, SERVICE, AND TECHNICAL SUPPORT

PHONE: 708-598-3720 FAX: 708-598-3720 WWW.FAMILYFUNCOMPANIES.COM

STING INTERNATIONAL, © 2013 ALL RIGHTS RESERVED

“KIDDY KRUISIN UPRIGHT”

TABLE OF CONTENTS

1. GAME FEATURES	3
2. PLAY INSTRUCTIONS	3
3. DIMENSIONS & TECHNICAL PARAMETERS	4
4. PARTS OF THE MACHINE	5
5. INTEGRAL STRUCTURE OF THE GAME	7
6. INSTALLATION OF THE GAME	8
8. POWER SUPPLY	9
10. HARDWARE COMPONENTS	10
11. DRIVING VIDEO GAME SOFTWARE DESCRIPTION	11
12. WIRING DIAGRAMS	17
13. PARTS LIST	18

1. GAME FEATURES

1. FULL GELCOAT FIBERGLASS CABINET IS RICHLY DETAILED AND FEATURES MANY CUSTOMIZED PARTS AND HIGHLIGHTS SUCH AS WORKING TURN SIGNAL LAMPS, and LIGHTED DASH PANEL.
2. INTUITIVE VIDEO GAME PLAY FEATURES A 3D PC DATABASE AND FULLY INTERACTIVE COURSE WITH CHALLENGES FOR ALL AGES.
3. GAMEPLAY PROGRAMMING, PLAY TIME, BONUS OPTIONS AND TICKET OR DBV OPTIONS ARE EASILY ADJUSTABLE!
4. DBV OPERATION OR TICKET PAYOUT FEATURE IS OPTIONAL AND ADJUSTABLE BY THE OPERATOR IN THE GAME SET UP MENU!

2. PLAY INSTRUCTIONS

1. ENTER THE CORRECT NUMBER OF CREDITS. THE GAME WILL START AUTOMATICALLY WHEN THE PROPER NUMBER OF CREDITS HAS BEEN ENTERED. THE GAME SCREEN WILL DISPLAY THE INTERACTIVE GAME PLAY.
2. USE THE “GAS PEDAL” TO ACCELERATE YOUR CAR. TRY YOUR BEST TO COLLECT AS MANY “COINS” AS YOU CAN FOR INCREASING YOUR SCORE DURING THE GAME.
3. PRESS “JUMP” BUTTON TO AVOID ANY ROADBLOCKS OR FOR AVOIDING OTHER CARS. USE “JUMP” TO COLLECT HIGHER “COINS”.
4. PICK UP THE TURBO “GAS TANK” DURING YOUR DRIVE. THIS AWARDS THE TURBO EFFECT. YOUR CAR WILL SPEED UP AUTOMATICALLY!
5. AT GAME OVER, THE GAME WILL PAY OUT TICKETS ACCORDING TO YOUR SCORE! [ONLY IF THE GAME IS SET FOR THE “TICKET PAYOUT” FUNCTION IN THE GAME MENU AND OPTIONS].

3. DIMENSIONS & TECHNICAL PARAMETERS

(1) **GAME DIMENSIONS:**

OCCUPIED AREA: W85CM * D107CM * H150CM
(W33.5" * D42.1" * H59")

MAIN CABINET ASSY: W85CM * D55CM * H150CM
(W33.5" * D21.7" * H59")

SEAT BASE AND ASSY : W40CM * D75CM * H45CM
(W15.8" * D29.6" * H17.8")

(2) **POWER REQ:** AC 110V±5%, 50/60HZ, (or, AC220V±5% 50HZ)
FOR THE SPECIFIC VOLTAGE USE, PLEASE REFER TO
THE GAME'S NAMEPLATE.

(3) **MAXIMUM POWER:** 100W

(4) **WEIGHT:** 150 LBS. /68KGS

(5) **OPERATION TEMP:** -10~+40°C, 86PA~106PA. (INDOOR ONLY)



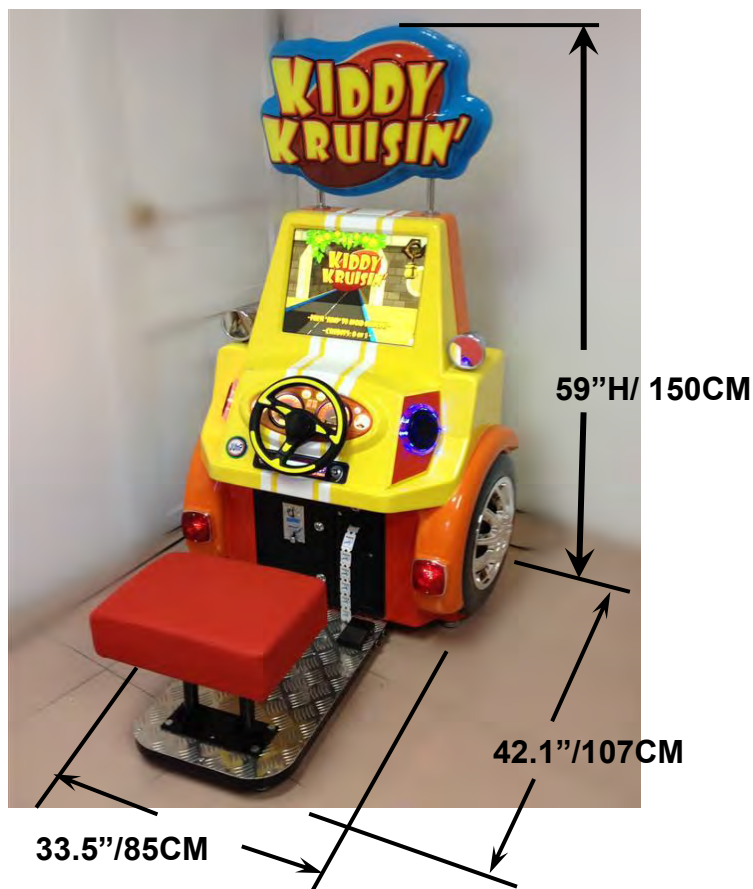

(6) **NUMBER OF PLAYERS:** 1 PLAYER



4. PARTS OF THE MACHINE

REFER TO THE CHART BELOW FOR THE MACHINE PARTS LOCATIONS AND THE CONTENTS OF THE SPARE PARTS KIT SUPPLIED WITH THE GAME.

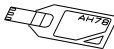
SPARE PARTS KIT CONTENTS:

NO	DESCRIPTION	SIZE	QTY	UNIT	IMAGE	REMARKS
1	AC POWER CABLE		1	PC		
2	FUSE	5XΦ20MM	2	PC		10A
3	GAME MANUAL		1	PC		
4	KEY FOR CASH BOX & BACK DOOR		2	PC		3157
5	KEY FOR COIN MECH DOOR & TICKET DOOR		2	PC		3172
6	STEERING WHEEL MICRO SWITCH		1	PC		
7	“JUMP” BUTTON MICRO SWITCH		1	PC		
8	FRONT LAMP LED		1	PC		

4.1 “U”-DISC SYSTEM BACK UP [GAME SOFTWARE REINSTALL]

IN THE UNLIKELY EVENT YOUR GAME SOFTWARE SHOULD BE INTERRUPTED AND THE GAME FAIL TO LOAD PROPERLY, THIS “U” DISC INCLUDED WITH YOUR GAME MAY BE USED TO RESTORE THE GAME SOFTWARE OPERATING SYSTEM.

YOUR GAME IS A PC BASED HARDWARE SYSTEM. SUDDEN POWER SURGES, HIGH CHARGES OF STATIC ELECTRICITY AND OTHER SUCH ABNORMAL IN RUSH OF CURRENT MAY CAUSE THIS. IT IS SIUMPLE AND FAST TO RESTORE THE SYSTEM WITH THE FOLLOWING PROCEDURE.

This machine has included an additional “U” disc for situations caused by power surges.



Function

In the event of a sudden surge of power, the video may freeze or the game may not log in normally. In this case, please take this U disc which is found next to the main PC and insert into USB port on host PC. After inserting, game system software will be reinitialized automatically. After installing, game will run normally. Please put U disc back into the storage port for future use if necessary.

5. INTEGRAL STRUCTURE OF THE GAME

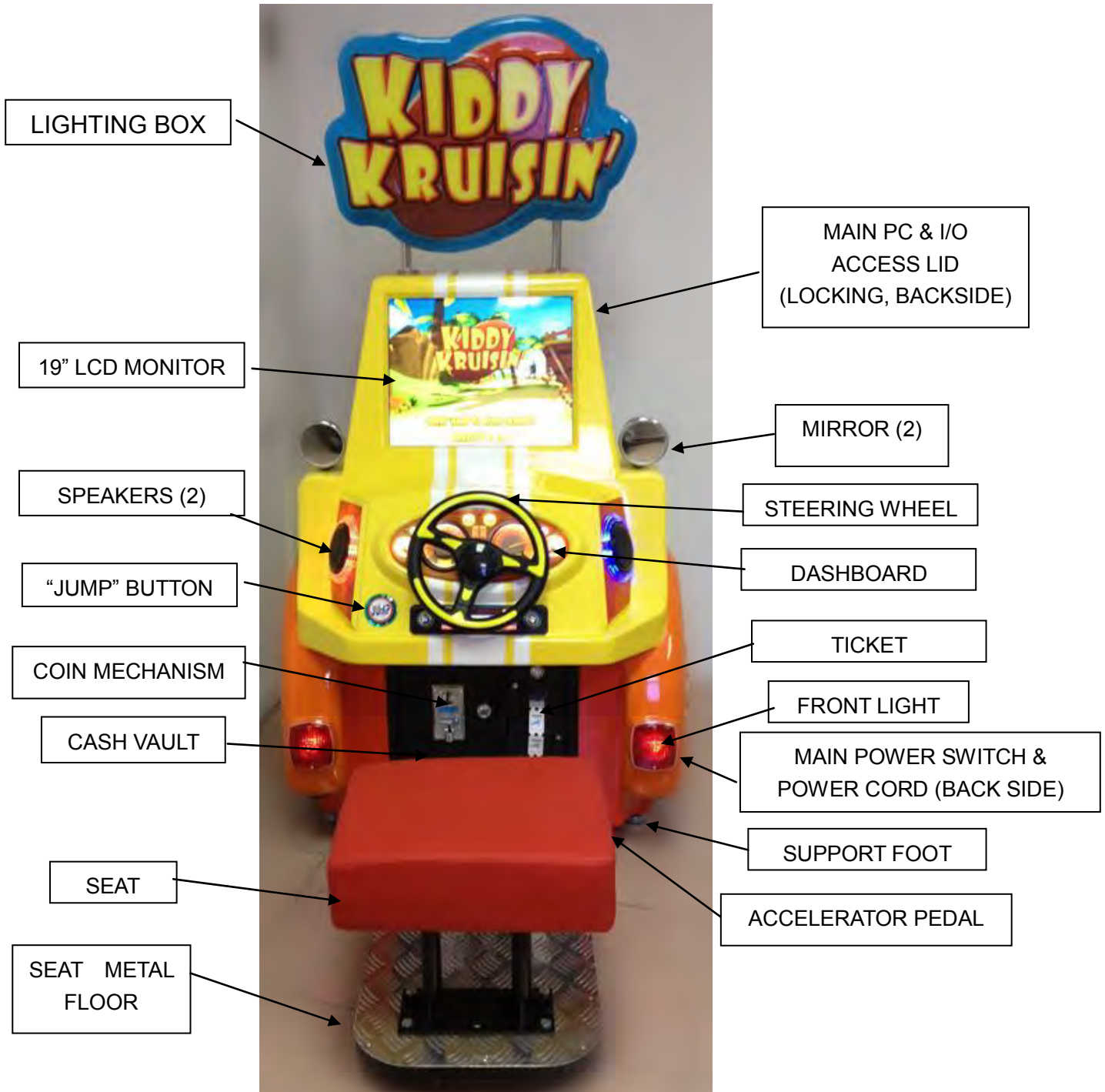

6. INSTALLATION OF THE GAME

(1) INSTALLATION GUIDANCE.

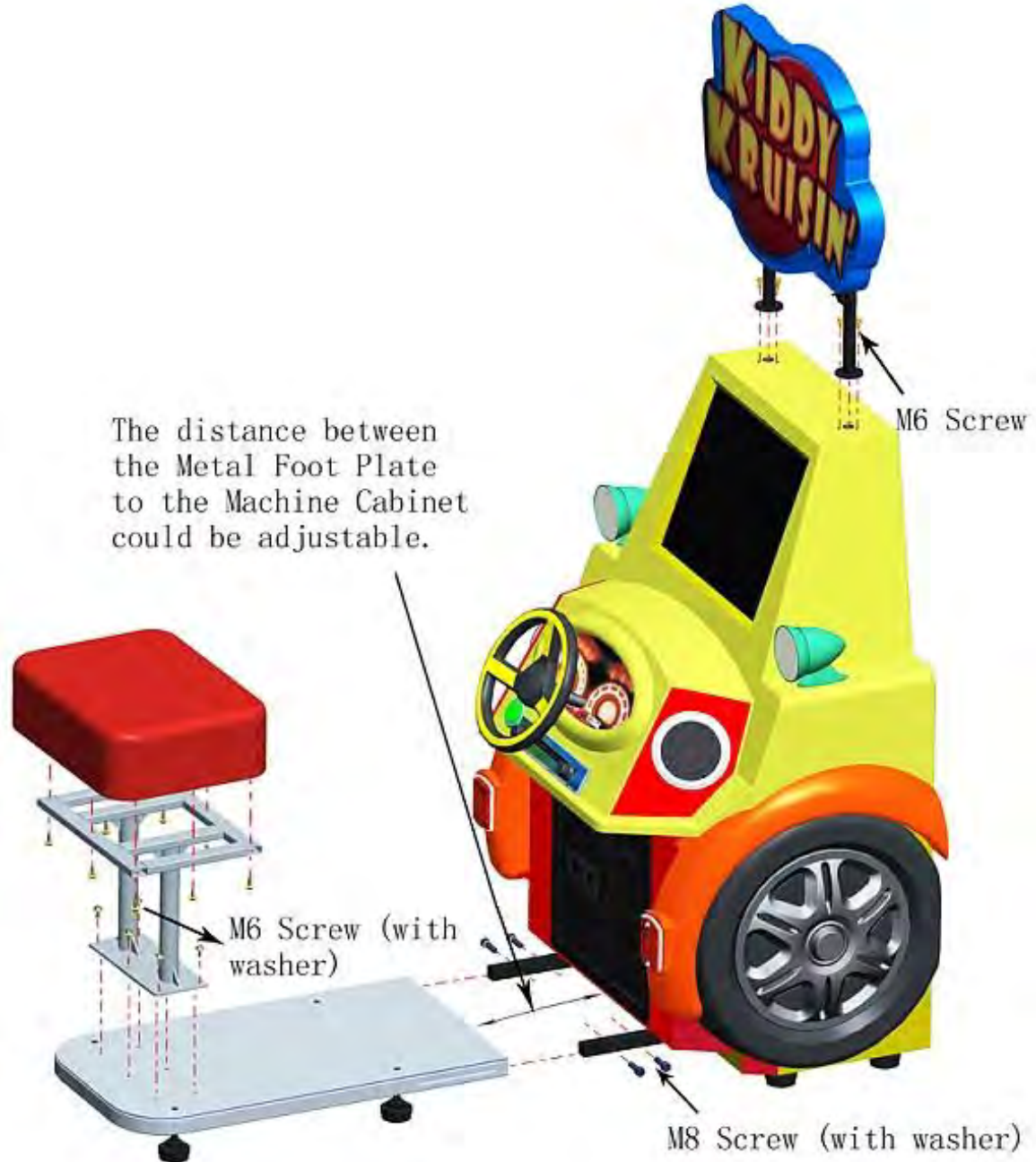

THE MACHINE MAY ONLY BE USED IN A SAFE, INDOOR ENVIRONMENT.
USE OF THE GAME OUTDOORS IS PROHIBITED.

7.POWER SUPPLY

(1) POWER SUPPLY INPUT;

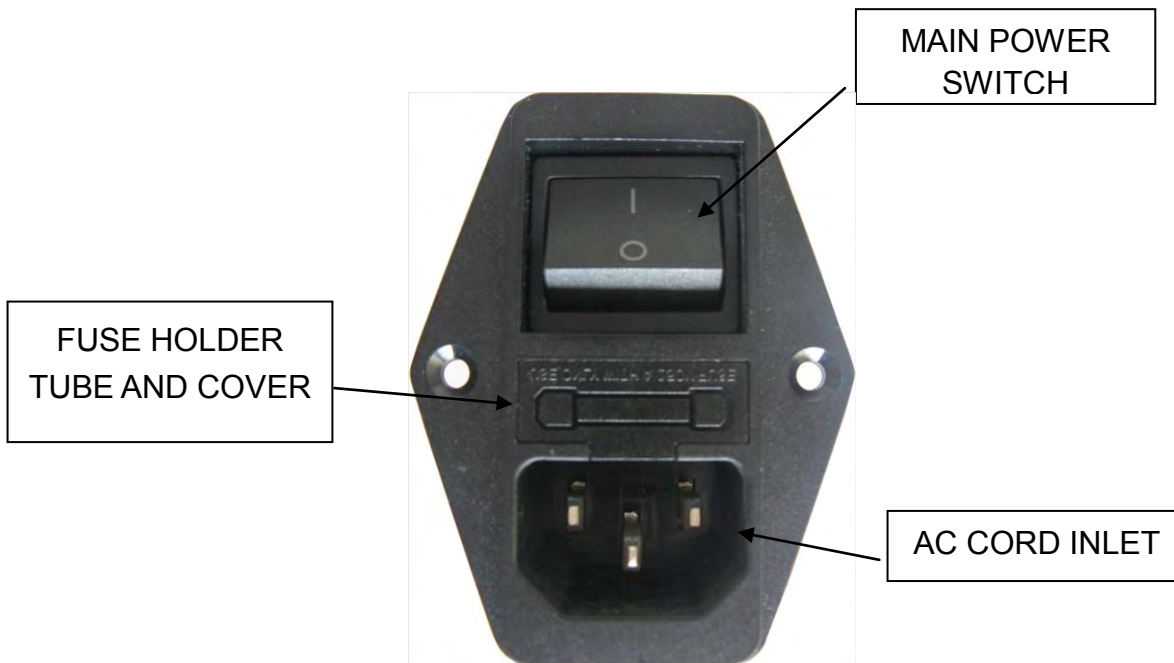

(2) THIS MACHINE USED FOR POWER 110V/AC 50/60Hz, (or, 220V±5% 50HZ). FOR THE SPECIFIC VOLTAGE USE, PLEASE REFER TO THE GAME'S NAME PLATE.

THERE IS A FUSE LOCATED IN THE FUSE HOLDER TUBE WHICH IS; 110V 10A, DIA 20MM (FOR 110V/AC VERSION) or, "220V 10A., DIA 20MM (FOR 220V/AC 50Hz VERSION).

8. HARDWARE COMPONENTS

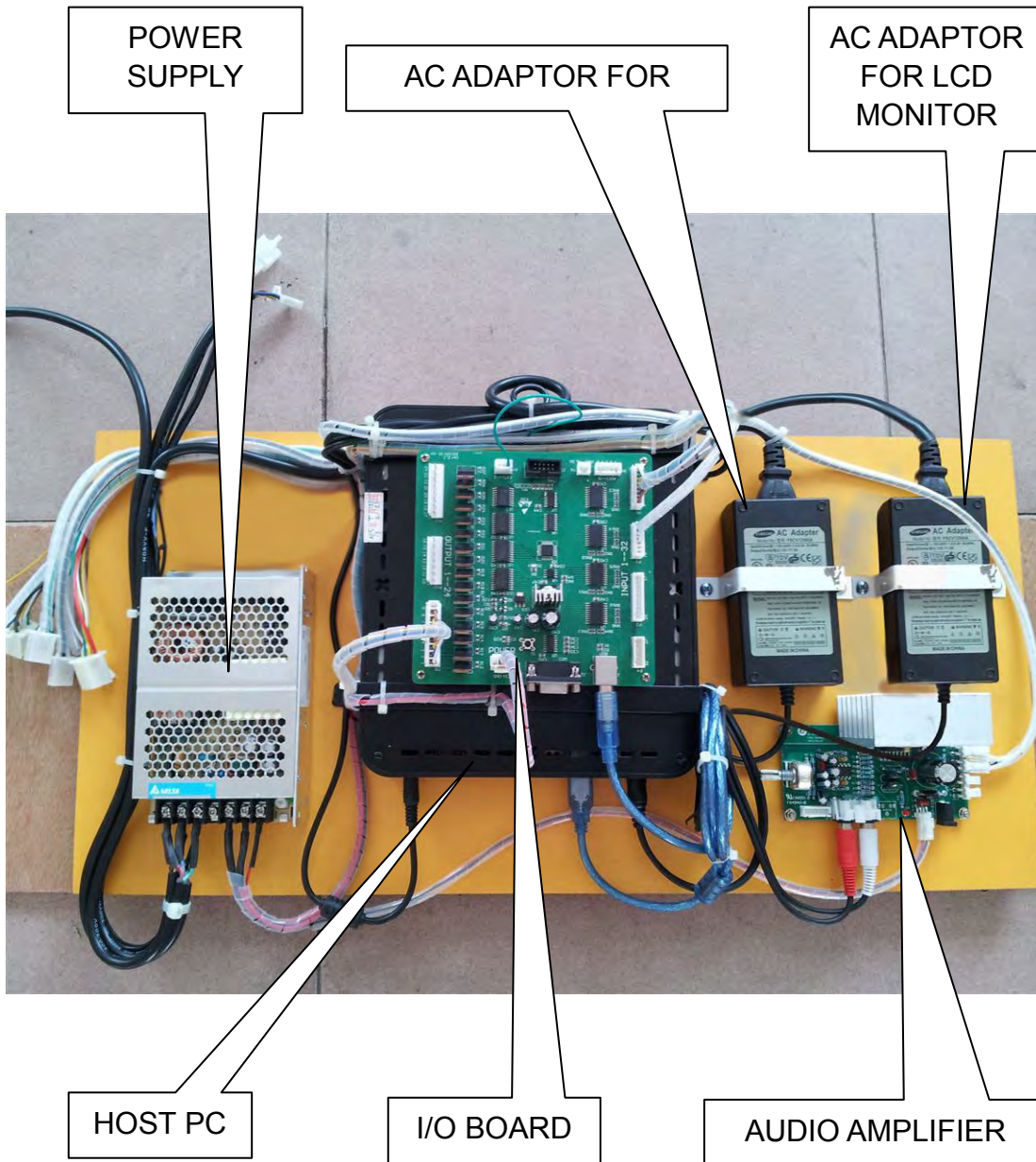

9. DRIVING VIDEO GAME SOFTWARE DESCRIPTION

(1) GAME ATTRACT & DEMO SCREEN:





PLAY TIME
REMAINING

CURRENT
SCORE

GAS TANK
TURBO
REWARD

PLAYER'S
VEHICLE

BONUS (TIME
EXTENDED)

CURRENT
SPEED



COINS = 1
PT. SCORE



- WHEN THE TICKET FUNCTION IS ENABLED AND A TICKET MECHANISM IS INSTALLED [NO DBV], GAME SCORES ARE TOTALLED AND CONVERTED INTO TICKET AWARDS WHICH ARE DISPENSED AT THE END OF THE GAME ACCORDING TO THE DESIRED TICKET PAYOUT SETTING WITHIN THE OPERATOR MENU AND ADJUSTMENTS.
- WHEN A DBV OPTION HAS BEEN INSTALLED, THE TICKET MECHANISM FUNCTION IS DISABLED AND ONLY THE GAME SCORE IS DISPLAYED.

(2) GAME OPERATIONS & SET UP MENU ON FOLLOWING PAGES:

OPEN THE COIN DOOR AND YOU WILL SEE THE SETTING/METER PANEL AT THE TOP OF COIN BOX;



↓ TO ENTER THE MENU STATE ON SCREEN- PRESS: “MENU” INSIDE THE DOOR ON THIS SETTING/METER PANEL, THEN YOU WILL SEE THE SCREEN AS BELOW. CONTINUE TO PRESS “MENU” UNTIL YOU HIGHLIGHT THE WORD: “ENTER”. TO ENTER THE MENU STATE, THEN PRESS “OPTION”. IN THE EVENT YOU ACCIDENTALLY CHANGE THE PASSWORD, PLEASE ENTER THE DEFAULT PASSWORD (DEFAULT PASSWORD IS 0000).



↑ AFTER ENTER PASSWORD, PRESS “MENU”, MOVE TO ENTER, THEN PRESS; “OPTION” TO ENTER INTO NEXT PAGE (SEE FIGURE 2)

PRESSING “MENU” AGAIN AND AGAIN ADVANCES THROUGH ALL OF THE VARIOUS MENUS

AVAILABLE. PRESSING “OPTION”, WHEN IN ANY GIVEN MENU, WILL HIGHLIGHT THE OPTION DESIRED AND STEP THROUGH THE OPTIONS OF THAT MENU.

WHEN ALL OF THE MENU OPTIONS ARE CHOSEN- OR AT ANY TIME- THE OPERATOR SIMPLY CAN PRESS THE “JUMP” BUTTON ON THE CONTROL PANEL AND RETURN TO NORMAL GAME PLAY.

YOU MAY EXIT THE MENU AND RETURN TO NORMAL GAME PLAY FROM ANY MENU SCREEN EXCEPT “TEST” BY PRESSING THE “JUMP” BUTTON.



PRESS THE “JUMP” BUTTON ON THE CONTROL PANEL AT ANY TIME TO EXIT THE MENU EXCEPT IN THE TEST MENU!



GAME OPERATIONS & SET UP MENU

WHEN THE TICKET OPTION IS ENABLED, THE FOLLOWING TICKET OPTIONS MAY BE SET. TICKETS DISPENSED FOR COINS COLLECTED AT THE END OF GAME PLAY:

TOTAL COINS	0-10	11-15	16-20	21-25	26-30	31-35
TICKET OPTION 1	0	1	2	3	4	5
TICKET OPTION 2	0	2	4	6	8	10
TICKET OPTION 3	2	4	6	8	10	12
TICKET OPTION 4	4	6	8	10	12	14



GAME OPERATIONS & SET UP MENU

GAME TEST FUNCTIONS

HIGHLIGHT DESIRED TEST FUNCTIONS AND PRESS 'ENTER' FOR TEST

COIN MECHANISM

TICKET MECHANISM

DBA OPTION

STEERING WHEEL

ACCELERATOR PEDAL

'JUMP' BUTTON

LAMP TEST

BASE MOTOR TEST

MONITOR TEST

AUDIO TEST

AUDIO 'DING' WHEN COIN ENTERED

DISPENSES ONE TICKET

SERIES OF AUDIO 'DING'S WHEN BILL ENTERED

TURN WHEEL LEFT and RIGHT LIMIT 'DING' AUDIO

PRESS FOR AUDIO 'DING'

PRESS FOR AUDIO 'DING'

ALL CONTROLLED LAMPS FLASH

OPERATES BASE MOVEMENT CYCLE





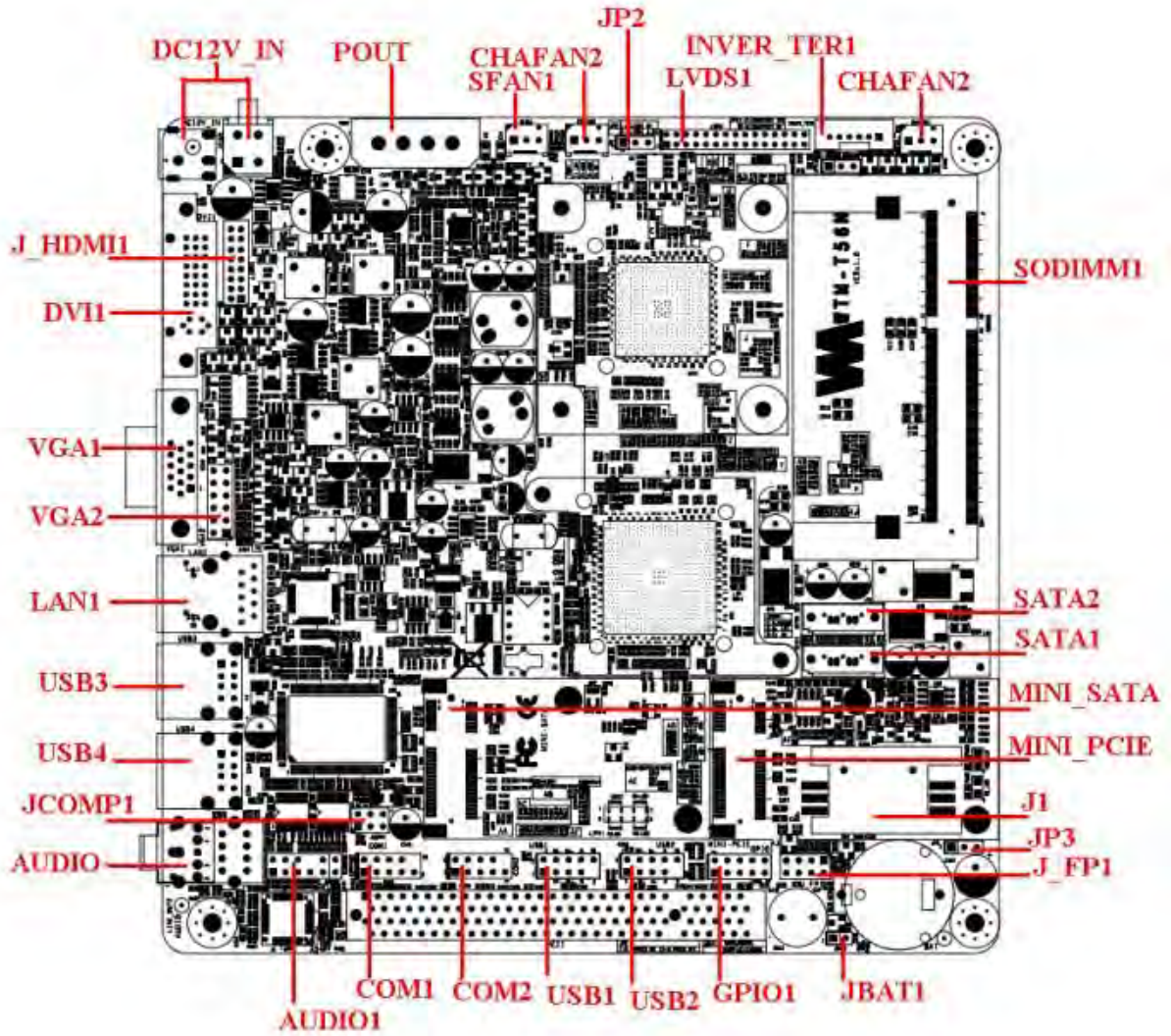

MONITOR RESET

PLAYS MAIN BACKGROUND TUNE







10. WIRING DIAGRAM



11. GAME PARTS LIST AND LOCATION



PART NO.	PART'S NAME	LOCATION	IMAGE	QTY	UNIT
KKU-001	HOST PC	INSIDE BACK CABINET UPPER		1	PC
KKU-002	I/O BOARD	INSIDE BACK CABINET UPPER		1	PC
KKU-003	AUDIO AMP PCB	INSIDE BACK CABINET LOWER		1	PC
KKU-004	TICKET DISPENSER TRANSFER PCB	INSIDE BACK CABINET LOWER		1	PC
KKU-005	POWER CABLE	LOWER BACK CORNER AT AC INLET		1	PC
KKU-006	DATA CABLE	INSIDE BACK CABINET UPPER		1	PC

KKU-007	SIGNAL CABLE	INSIDE BACK CABINET UPPER		1	PC
KKU-008	SPEAKER LAMP LED PCB	FRONT SPEAKER(S) LEFT & RIGHT		2	PC
KKU-009	FRONT FENDER LAMP LED	FRONT LEFT & RIGHT SIDE OF CABINET		2	PC
KKU-010	HEADER SIGN LED STRIP	INSIDE THE HEADER GRAPHIC MARQUEE		2	PC
KKU-011	RADIO GRAPHIC LED LAMP	INSIDE BEHIND THE FRONT RADIO GRAPHIC		1	PC
KKU-012	19" LCD MONITOR	FRONT		1	PC
KKU-013	MONITOR TEMPERED GALSS	MOUNTS IN FRONT OF THE LCD MONITOR		1	PC

KKU-014	POWER SUPPLY	INSIDE BACK CABINET UPPER		1	PC
KKU-015	AC ADAPTOR FOR LCD MONITOR	INSIDE BACK CABINET UPPER		1	PC
KKU-016	AC ADAPTOR FOR HOST PCB	INSIDE BACK CABINET UPPER		1	PC
KKU-017	POWER SUPPLY INPUT	LOWER BACK OF CABINET REAR		1	PC
KKU-018	FAN	INSIDE OF THE BACK CABINET UPPER		1	PC
KKU-019	STEERING WHEEL	FRONT		1	PC
KKU-020	GAME MENU, COIN & METER PANEL	INSIDE CABINET COIN DOOR		1	SET



KKU-021	ENTROPY TICKET DISPENSER	INSIDE FRONT TICKET DOOR		1	PC
KKU-022	COIN SELECTOR	INSIDE FRONT COIN DOOR		1	PC
KKU-023	GAS PEDAL	FOOT PLATE BELOW THE TICKET DOOR		1	PC
KKU-024	SPEAKER	INSIDE CABINET LEFT & RIGHT SIDE		2	PC
KKU-025	"JUMP" BUTTON LAMP WITH SWITCH	INSIDE THE "JUMP" BUTTON		1	PC
KKU-026	GAS PEDAL MICRO SWITCH	INSIDE THE GAS PEDAL		1	PC
KKU-027	STEERING WHEEL MICRO SWITCH	INSIDE THE STEERING WHEEL		2	PC

KKU-028	"JUMP" BUTTON	CONTROL PANEL		1	PC
KKU-029	FRONT LAMP COVER	FRONT LEFT & RIGHT SIDE FENDER		2	PC
KKU-030	FRONT LAMP FRAME	UNDERNEATH THE FRONT LAMP COVERS LEFT & RIGHT		2	PC
KKU-031	THREE IN ONE DOOR	FRONT		1	PC
KKU-032	SPEAKER COVER	COVERS THE SPEAKER(S) LEFT & RIGHT SIDE		2	PC
KKU-033	POWER SUPPLY INPUT METAL FRAME	INSIDE, BEHIND THE POWER SUPPLY INPUT		1	PC
KKU-034	CASTOR FRAME	UNDERNEATH THE MAIN CABINET		2	PC

KKU-035	SEAT METAL SUPPORT PILLAR	SEAT BASE PART		1	PC
KKU-036	SEAT BASE METAL PLATE FLOOR ASSY	SEAT BASE		1	PC
KKU-037	STEERING WHEEL METAL SET	FRONT BEHIND THE STEERING WHEEL ASSY		1	SET
KKU-038	HAND HOLDER	BACK CABINET UPPER PART		2	PC
KKU-039	GRILL COVER FOR FAN	BACK CABINET UPPER PART		1	PC
KKU-040	FOOT PLATE SUPPORT LEVELOR	UNDERNEATH THE SEAT METAL BASE PART		4	PC
KKU-041	MAIN CABINET SUPPORT LEVELOR	UNDERNEATH THE MAIN CABINET		4	PC

KKU-042	CASTOR WHEEL	UNDERNEATH THE MAIN CABINET		2	PC
KKU-043	HEADER SIGN SUPORT POST	BETWEEN THE HEADER SIGN AND MAIN CABINET		2	PC
KKU-044	3157 LOCK	COIN BOX DOOR		1	SET
KKU-045	3172 LOCK	COIN SELECTOR DOOR & TICKET DISPENSER DOOR		2	SET
KKU-046	RADIO KNOB	RADIO GRAPHIC FAUX KNOB		2	PC
KKU-047	SIDE MIRROR(S)	ABOVE FENDERS LEFT & RIGHT SIDE		2	PC
KKU-048	WHEEL COVER	BOTH SIDES LEFT & RIGHT		2	PC

KKU-049	SEAT CUSHION	SEAT PART		1	PC
KKU-050	HEADER LIGHT BOX GRAPHIC	HEADER MARQUEE COVER VACUUM FORM		1	PC
KKU-051	DASHBOARD GRAPHIC	FRONT CONTROL PANEL		1	PC
KKU-052	RADIO GRAPHIC	FRONT CONTROL PANEL		1	PC
KKU-053	SERIAL NO. LABEL	BACK SIDE		1	PC
KKU-054	CAUTION LABEL	BACK SIDE		1	PC
KKU-055	"JUMP" BUTTON LABEL	INSIDE THE "JUMP" BUTTON		1	PC

KKU-056	GAS PEDAL LABEL	CABINET FRONT ABOVE GAS PEDAL ASSY		1	PC
KKU-057	ELETRIC WARNING LABEL	INSIDE UPPER PART		1	PC
KKU-058	FAN WARNING LABEL	ABOVE THE FAN		1	PC

