



GAME OPERATION & INSTRUCTION MANUAL





THIS GAME IS INTENDED FOR INDOOR USE ONLY

CONTENTS

1. SPECIFICATION	1
2. INTRODUCTION	2
2-1 OVERVIEW.....	2
2-2 IMPORTANT SAFETY INFORMATION.....	3
2-3 SET UP.....	3
3. PACKAGE CONTENTS	4
4. INSTALLATION	4
4-1 LOCATIONS TO AVOID.....	5
4-2 INSTALLING AT SITE.....	5
5. CONNECTING THE POWER CORD	6
5-1 WIRE HOLDER.....	6
6. PARTS DESCRIPTION	7
6-1 GAME APPEARANCE and FEATURES.....	7
6-2 TICKET MECHANISM (ENTROPY).....	8
6-3 BILL ACCEPTOR OPTION (OPERATOR INSTALLED).....	9
6-4 COIN MECHANISM (MECHANICAL) D-200.....	12
6-5 TRUNK.....	14
7. SERVICE	15
8. CONTROL SIGNAL AND INSTRUCTION	18
8-1 PCB LAYOUT.....	18
8-2 HOW TO ENTER INTO MENUS.....	18
9. INSTRUCTION OF GAME PLAY	23
10. GENERAL TROUBLESHOOTING	25
11. PART LIST	26
11-1 BASE MECHANICAL ASSY.....	26
11-2 HARDWARE COMPONENT.....	28
11-3 MACHINE PARTS LIST.....	30

1. SPECIFICATION

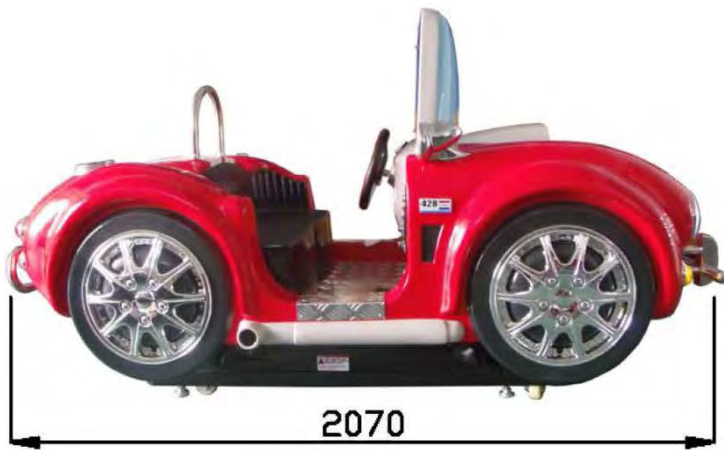

(1) Dimension: L2070mm, W1080mm, H1170mm
W43" x D81" x H44"

(2) Weight: 164KG 331 Lbs.

(3) Voltage: AC 110V -120V 50Hz-60Hz;

(4) Power: 68W-450W (when playing, the more load, the higher the power required)

(5) Current: 0.9A-6A

Note: Please refer to the nameplate at the back of game for the actual voltage

(6) Environment: (indoor) temperature -10°C ~ +40°C; humidity ≤90% ; pressure 86Pa ~ 106Pa

Note: Game parameters are subject to change without notice.

2. INTRODUCTION

2-1 OVERVIEW

Thank you for purchasing the KC-COBRA video game ride.

This owner's Manual is intended to provide detailed descriptions together with all the necessary information regarding the general operation of electronic assemblies, servicing control, spare parts, etc., pertaining to the game.

This manual is intended for the owner, operator, personnel and managers in charge of operation of the product. Operate the product after carefully reading and sufficiently understanding the instructions. If the product fails to function satisfactorily, non-technical personnel should under no circumstances attempt to service the internal system.

To Maintain Safety:

To ensure the safe usage of the product, be sure to read the following before using the product. The following instructions are intended for the users, operators and the personnel in charge of the operation of the product. After carefully reading and sufficiently understanding the warning display and cautions, handle the product appropriately. Be sure to keep this operation manual nearby the product or elsewhere convenient for referring to it when necessary.

For the safe usage of the product, the following pictographs are used:



Indicates: "HANDLE WITH CARE". In order to protect the human body and equipment, this display is attached to places where the instruction manual should be referred to.



Indicates: a "PROTECTIVE EARTH TERMINAL". Before operating the equipment, be sure to connect it to the ground. (The step may be omitted for products in which a power cable with earth is used.)

↓ Be sure to understand the contents of the displays before operating the equipment or reading the text.



DANGER

Indicates that mishandling the product by disregarding this pictograph may cause severe injury or even death.



WARNING

Indicates that mishandling the product by disregarding this warning may cause a potentially hazardous situation which can result in death or serious injury.



CAUTION

Indicates that mishandling the product by disregarding this caution may cause a slight hazardous situation which can result in personal injury and/or material damage.

2-2 IMPORTANT SAFETY INFORMATION

- Unplug the game from the AC wall receptacle when servicing this product. Failure to do so could result in serious injury to yourself or others.
- Use only a GROUNDED AC receptacle. Failure to do so could result in improper operation or damage to the game and could void your warranty. If you are unsure that your AC receptacle is properly grounded, have a qualified electrician perform this check for you.
- Always be sure power to the game is turned off when doing even routine maintenance otherwise, moving parts could activate unexpectedly causing injury.
- This product is heavy, necessitated by the design. When moving this game, be sure you have adequate help. Use a suitable dolly or hand truck where practical.

2-3 SET UP





- Be sure that the game is on a level surface. If the game is rocking unevenly on the floor adjust the legs to remove the rocking of the game.
- Be sure to plug the game into the proper A.C. GROUNDED receptacle. Do not use long extension cords unless absolutely necessary and if so, be sure it is a heavy duty cord of at least 16 Ga. and no longer than 20 ft. Check the label on the back of the game to make sure the power requirements of the game match that of your location.
- Turn the game on and check to be sure there are no unusual sounds and that everything appears to be working correctly.

3. PACKAGE CONTENTS

Be sure to check that you have received all packages indicated below.

☞ **Game Unit**

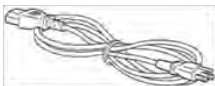
☞ **Accessories**

No.	Name	Specification	Picture	Qty.	Remark
1	Manual			1	English version
2	Key	GUO711		2	Ticket door, coin door, coin box, service door
3	Power code	US Version		1	Per request
4	Fuse	10A		1	

This machine has included an additional “U” disc for situations caused by power surges.



Function	In the event of a sudden surge of power, the video may freeze or the game may not log in normally. In this case, please take this U disc which is found next to the main PC and insert into USB port on host PC. After inserting, game system software will be reinitialized automatically. After installing, game will run normally. Please put U disc back into the storage port for future use if necessary.
----------	---

4. INSTALLATION

Check the parts list before installation. Verify that all parts that have been received and are in good condition

 **ATTENTION**
For indoor use only!

4-1 LOCATIONS TO AVOID

WARNING

The machine is designed for indoor use only. Never install this machine outdoors or in any of the following:

- Locations exposed to direct sunlight
- Locations subject to rain or water leakage.
- Unstable locations or locations subject to vibration.
- Dusty, hot, or damp locations.

4-2 INSTALLING ON SITE

The machine must be fixed on level ground. The product is equipped with 4 casters and 4 adjusters. When installation position /site has been determined, have the adjusters come in direct contact with the floor.

Establish a gap of about 5 mm between the floor and the casters and adjust the unit so that it will remain level.

- ① Move the product to the installation site.
- ② Bring the adjusters into direct contact with the floor. Use a wrench to align the height of the adjusters until the cabinet is perfectly level.

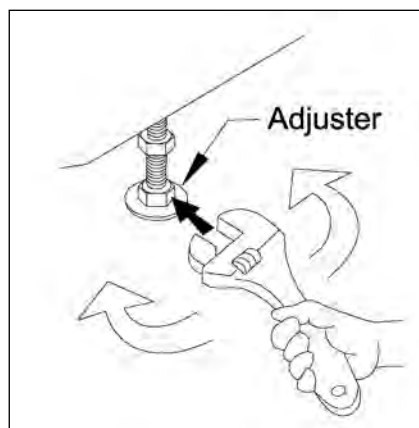

- ③ After setting, turn adjuster nuts upwards to tighten them and secure adjuster heights.

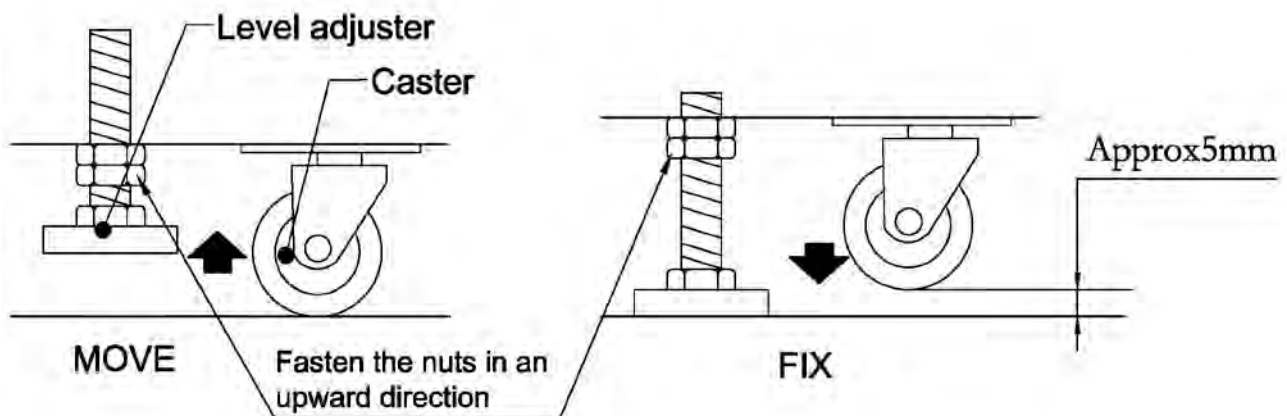

⚠ WARNING

- Disconnect game power before moving.
- Make sure all wheels are intact. Replace any wheels that are damaged or broken before moving the game.
- When moving the game, **DO NOT** slide the game across the floor.
- Ensure the game is level before connecting the power.
- To insure a long life of your product we recommend always wrapping the game with soft blankets for moving long distance to protect the finish.

5. CONNECTING THE POWER CORD

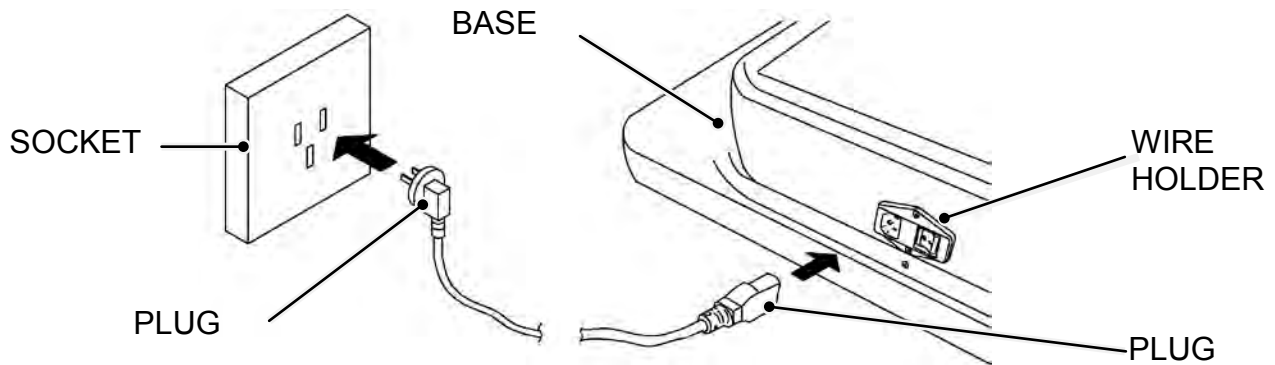

5-1 WIRE HOLDER

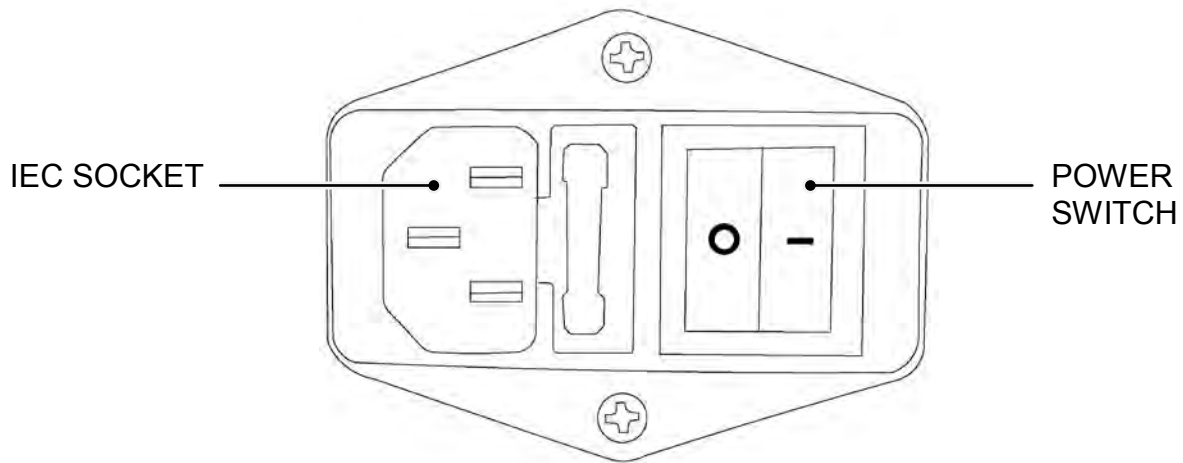

⚠ WARNING

- Do not put heavy items on power cord.

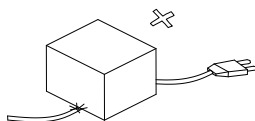

- Hold the power plug instead of the wire to draw the power cord out of the socket.

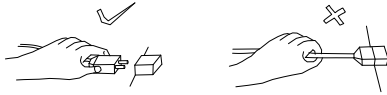

- Do not touch the power plug with wet hands.



- Do not draw or twist the cord or store near any high heat source.
- Do not place the cord where the player can easily trip over, or come in contact with it.



- Operate this game with the correct power and fuse configuration.

6. PARTS DESCRIPTION

6-1 GAME APPEARANCE AND FEATURES

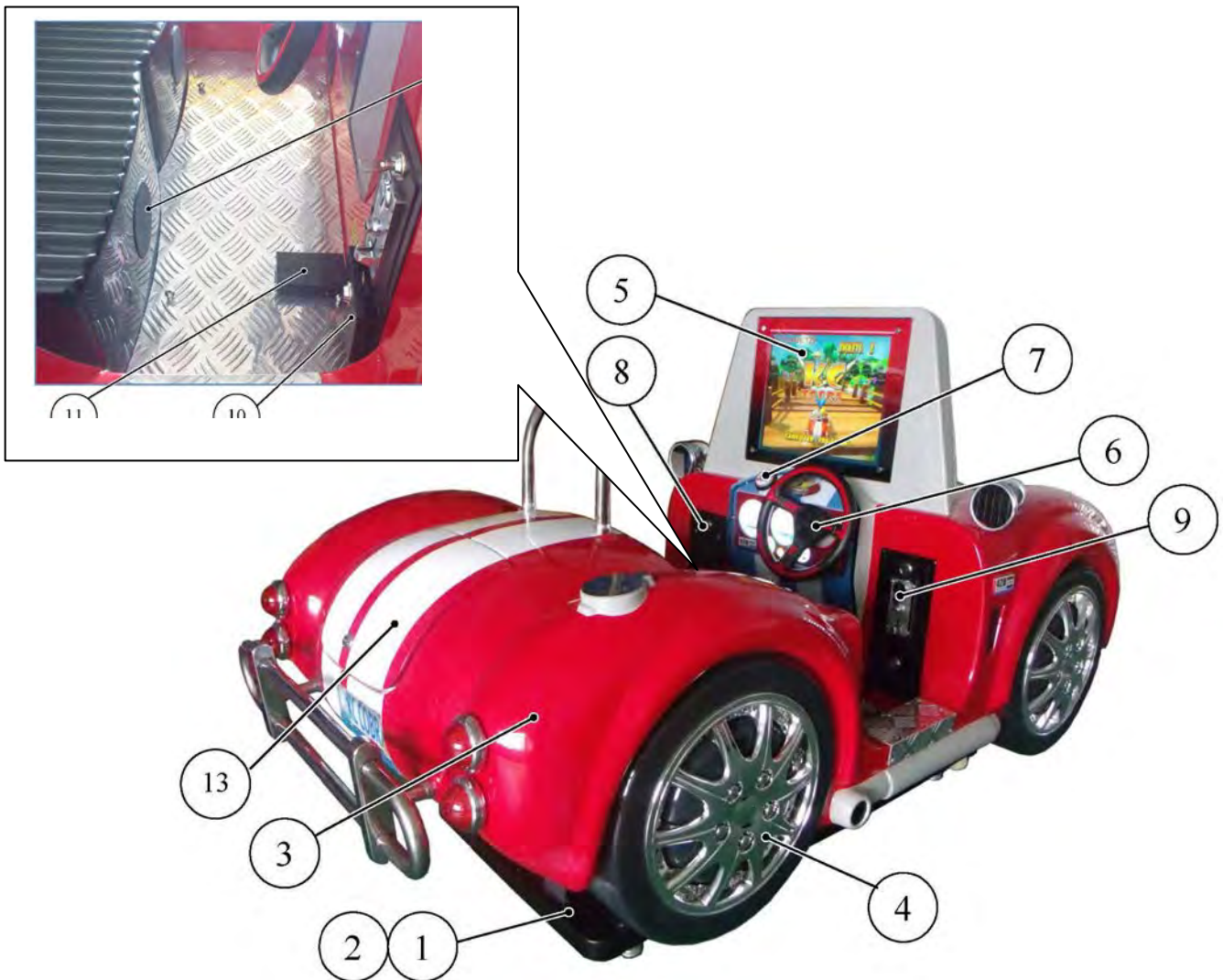

- 1 **BASE:** Base Mech
- 2 **PROTECTION SKIRT:** Prevent Player from reaching base
- 3 **FIBERGLASS CAR:** Main game (KC COBRA)
- 4 **CHROME WHEEL COVER:** Decoration
- 5 **19" LCD MONITOR:** For game video
- 6 **STEERING WHEEL:** Control car on video to move left and right
- 7 **"JUMP" BUTTON:** Press JUMP Button to jump car on video
- 8 **TICKET/ DBV DOOR :** For ticket version or DBV version. Key GUA71.
- 9 **COIN DOOR:** Key GUA711
- 10 **COIN BOX:** Key GUA711, collect coin.
- 11 **GAS PEDAL:** Speed up car.
- 12 **SPEAKER COVER:** Sound.
- 13 **TRUNK:** Key GUA711, reach to mainboard, amplifier board, main engine.

6-2 TICKET MECHANISM (ENTROPY)



NOTE

For Ticket version only!

How to fill the ticket

Open the Ticket Door, place the Tickets into the TICKET HOLDER.

Feed the Tickets into the TICKET MECH.

- ① Unclip and remove the Ticket retainier

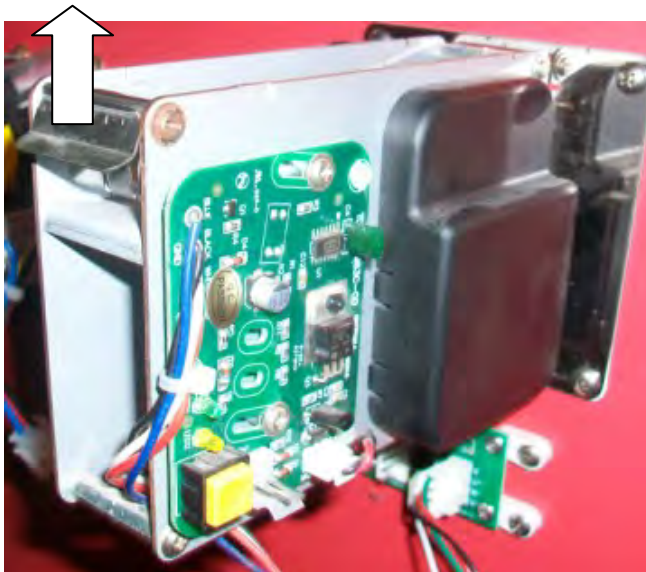

Picture 1

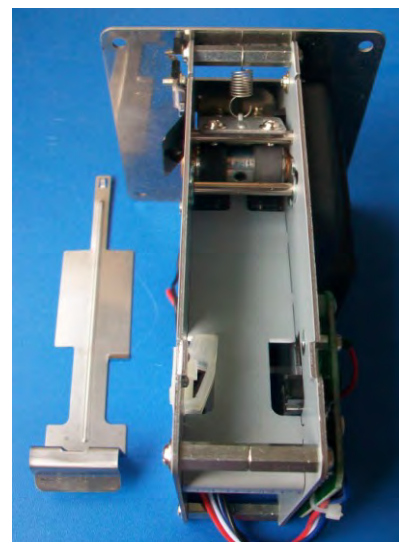

Picture 2

Feed the tickets into the mechanism making sure that the ticket passes through the sensor.



Replace the ticket retainer to secure tickets into position.
Press the TEST button on the PCB to draw tickets through the mechanism and out of the door.
Close the Ticket Door, tear off any excess tickets.



6-3 BILL ACCEPTOR (DBV) OPTION



NOTE

For DBV version only!

● Maintenance

To make sure the bill acceptor always works smoothly, please clean the internal parts every two weeks to every two months.

To clean the internal parts:

1. Press the buttons on the sides of bill path unit and pull the unit out.

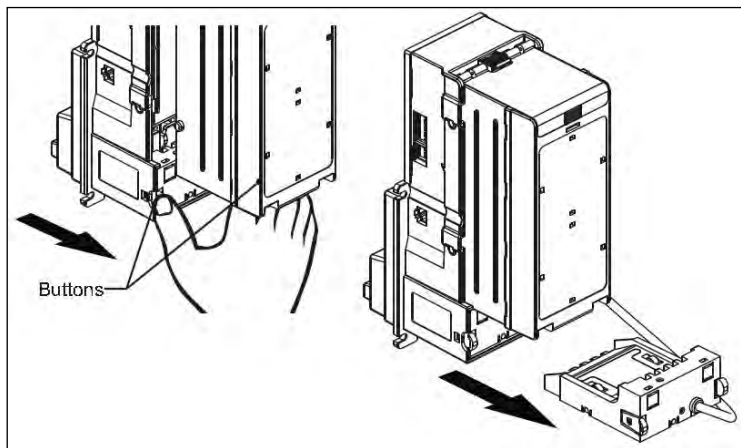

2. Use a soft, dry cloth or towel to clean the bill path and sensors.

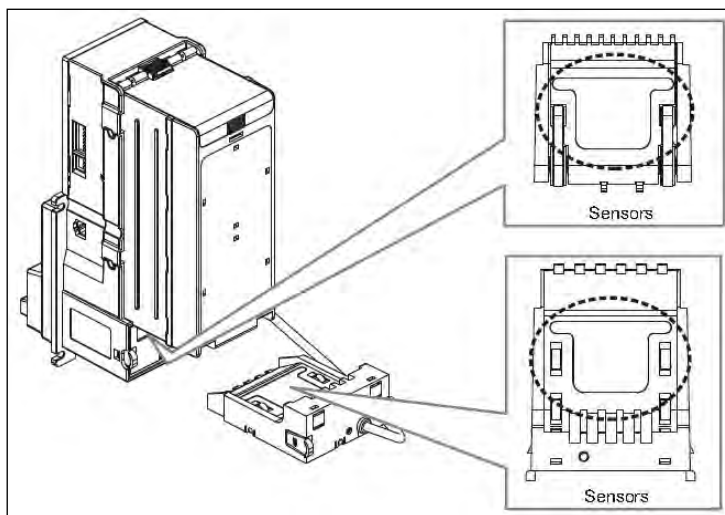

⚠ CAUTION

Do not use an organic solvent such as gasoline or paint thinner to clean the unit.

● **Trouble Shooting (Continued on the next page)**

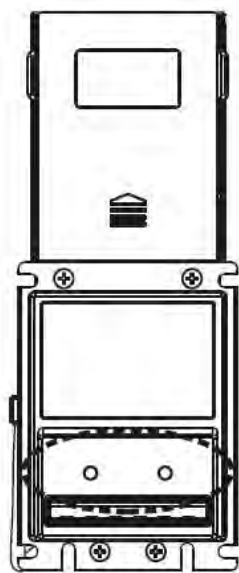

Bezel LED

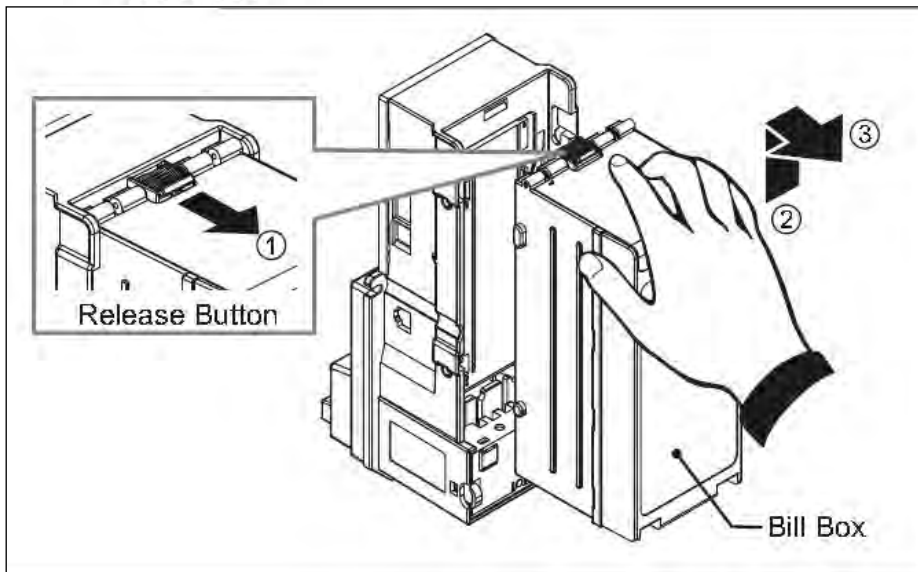

DIAGNOSTICS		Bezel LED (Green LED) LED ON = OK LED OFF =POWER OFF
LED Flashes	Status	Corrective Actions
1	Bill jammed	Remove the bill box by sliding the top button and the bill path unit (as above figure), and then remove the jammed bill.
2	Disable	Inspect for right DIP switch setting.
3	Recognition sensor error.	Inspect for foreign objects on sensor or bill path and clean.
3+2	Hook sensor error.	Inspect for foreign objects on security

3+5 (Optional)	Out sensor error.	Inspect for foreign objects on sensor or bill path and clean.
5	Bill box has been removed.	Replace the bill box.
6	Stacker error or stacker full.	Empty the bill box.
7	Motor error.	Inspect for foreign objects on bill path and clean.

6-4 COIN MECH (MECHANICAL) D-200

(Aluminum; adjustment, reject iron material coin)

Scope of dimension : D=25mm-25.5mm, T=1.8mm

DC12V+/-2V,temperature -30-+120° ;

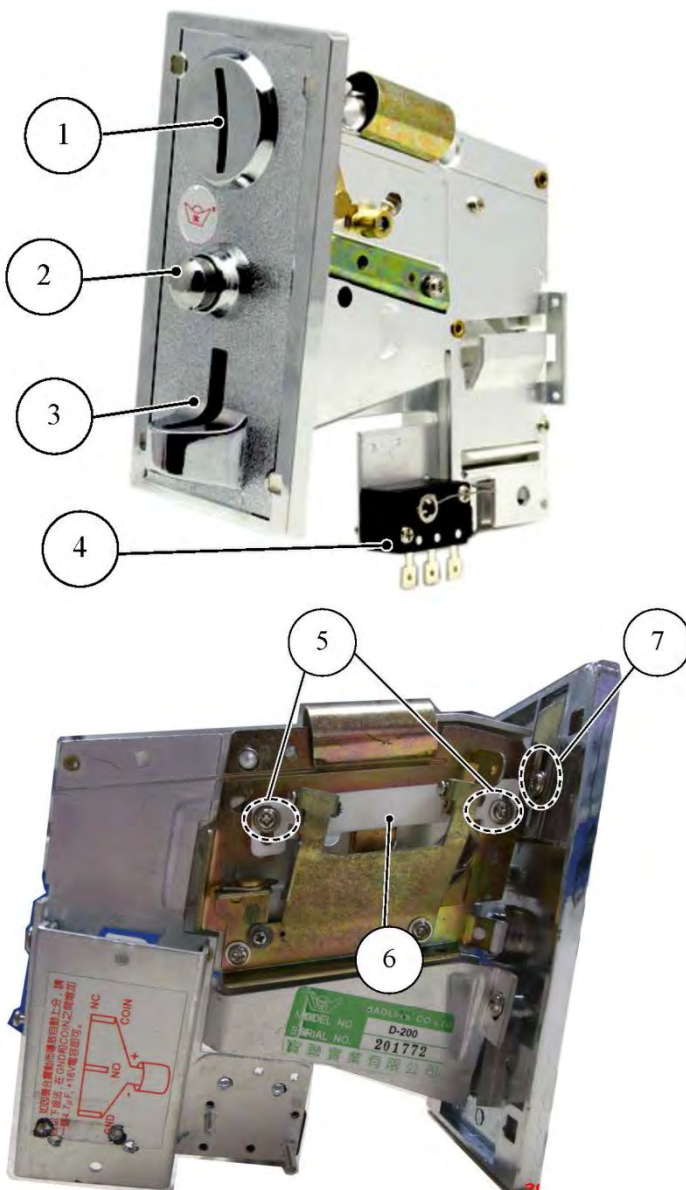

1 COIN SLOT 2 REJECT BUTTON 3 REJECT SLOT 4 SWITCH
5 SCREW FOR ADJUSTMENT 6 ADJUSTMENT ROD 7 SCREW

Press Reject Button, the jamming coin will come out to the Reject Slot. If coin cannot come out after press Reject Button, please take apart the mechanism to take out the jammed coin.

Note: please cut off the power before taking out the coin Mechanism.

Adjustment: Loosen screw # 5, move rod #6 up and down per coin dimension. Adjust the fixed sheet at the back of mechanism by screw #7 to avoid coin jamming

6-5 TRUNK

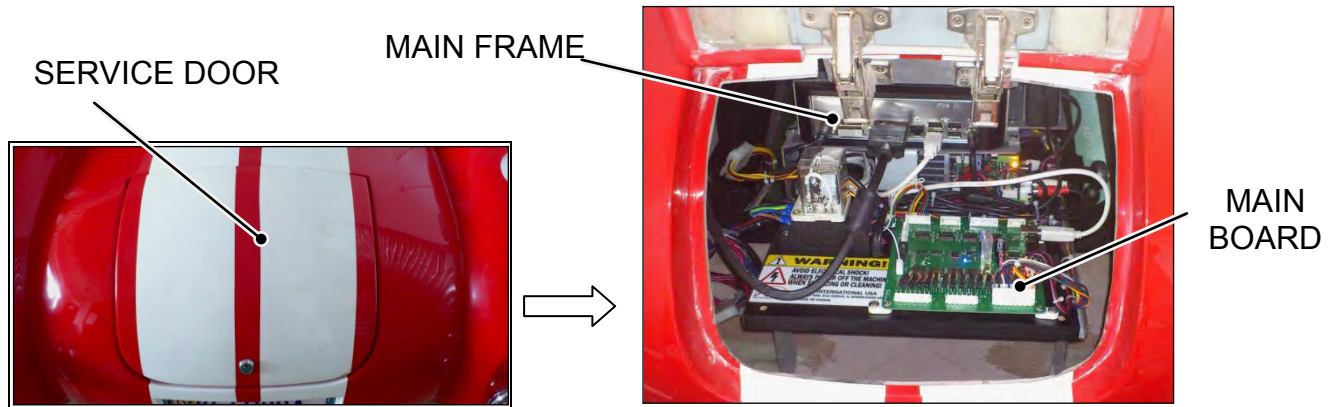

- **SERVICE DOOR** KEY GUA711, open the service door to service the computer host, circuit board etc
- **HOST COMPUTER**

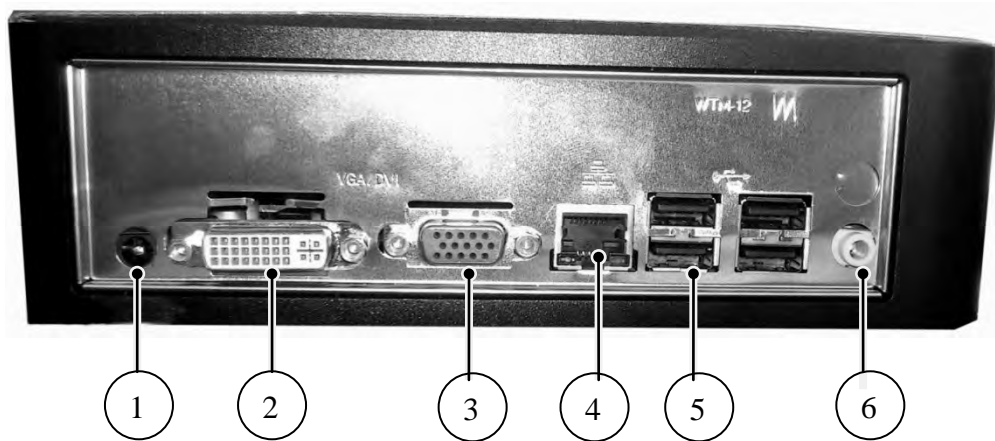

- 1 POWER INLET
- 2 DVI
- 3 VGA
- 4 NETWORK CONNECTION
- 5 USB (4PCS)
- 6 AUDIO CONNECTION

7. SERVICE

Please remove fiberglass car body completely off when servicing the base. When removing the body to access the base you should follow the instructions below.

1. Turn off power, unscrew screws around skirt and remove the skirt
2. Open back door, disconnect ALL connectors at both sides . See instruction below

Disconnect the connector at left side to separate fiberglass and electrical parts

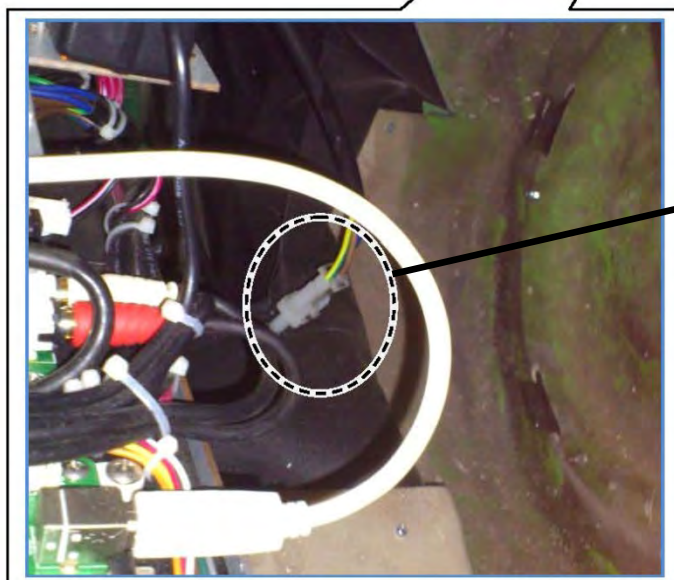
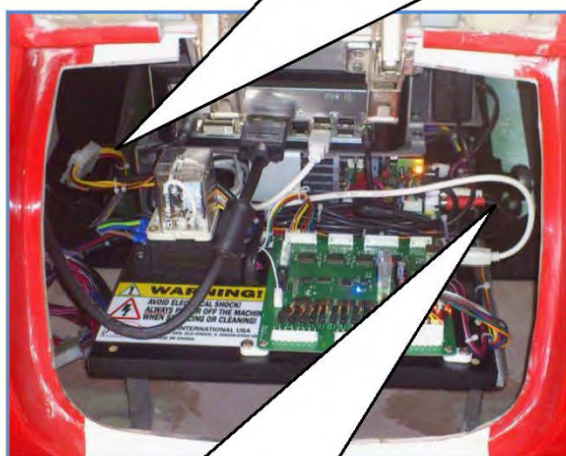
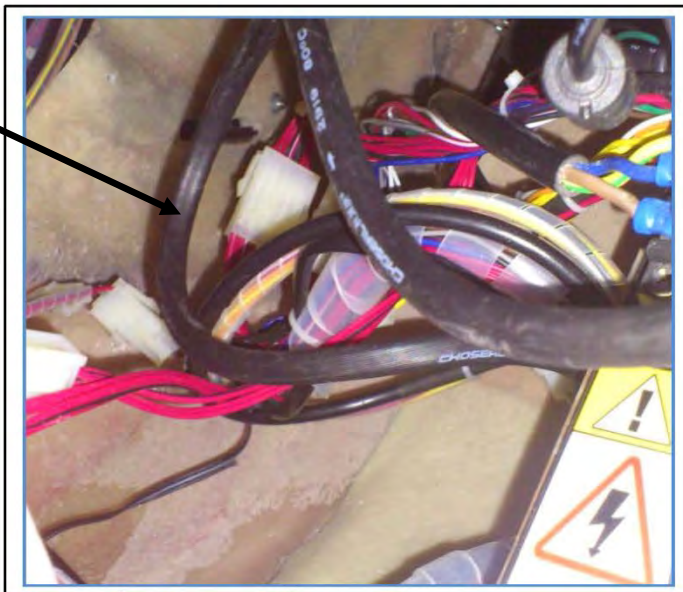

Disconnect connector at right side to separate motor and power

3. Unscrew and remove the 2 screws on fixed board, and slide (pull) out fixed board and the all electrical parts on it. See the circle on picture

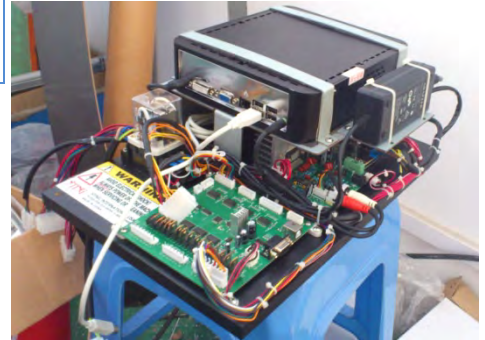
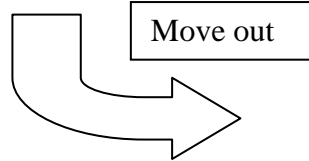

4. Look through the empty back door, you can see the long screw which fastens the fiberglass car and base. Take out this long screw. See the circle on picture

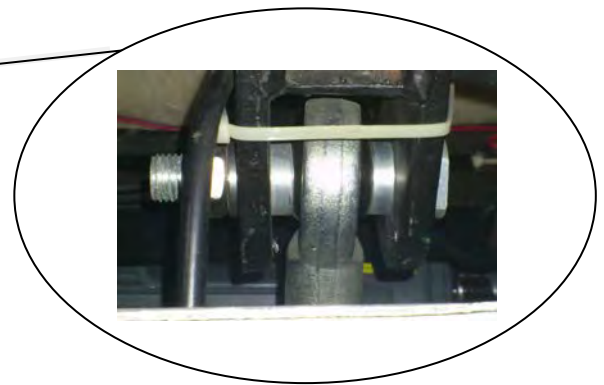
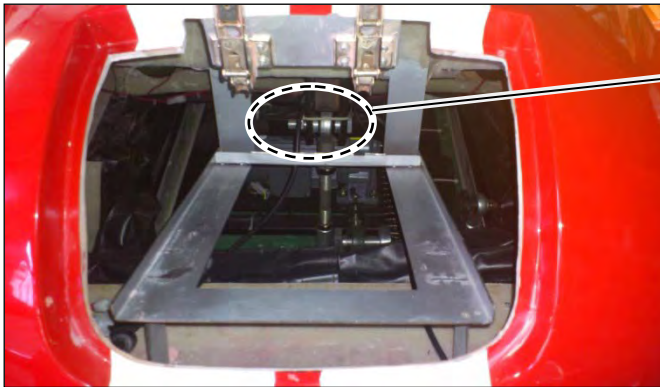

5. Unscrew 4 screws on aluminum plate.



Allen key

6. With two persons assisting, raise up the fiberglass car and remove it from base. (2 operators are necessary to raise up fiberglass car)

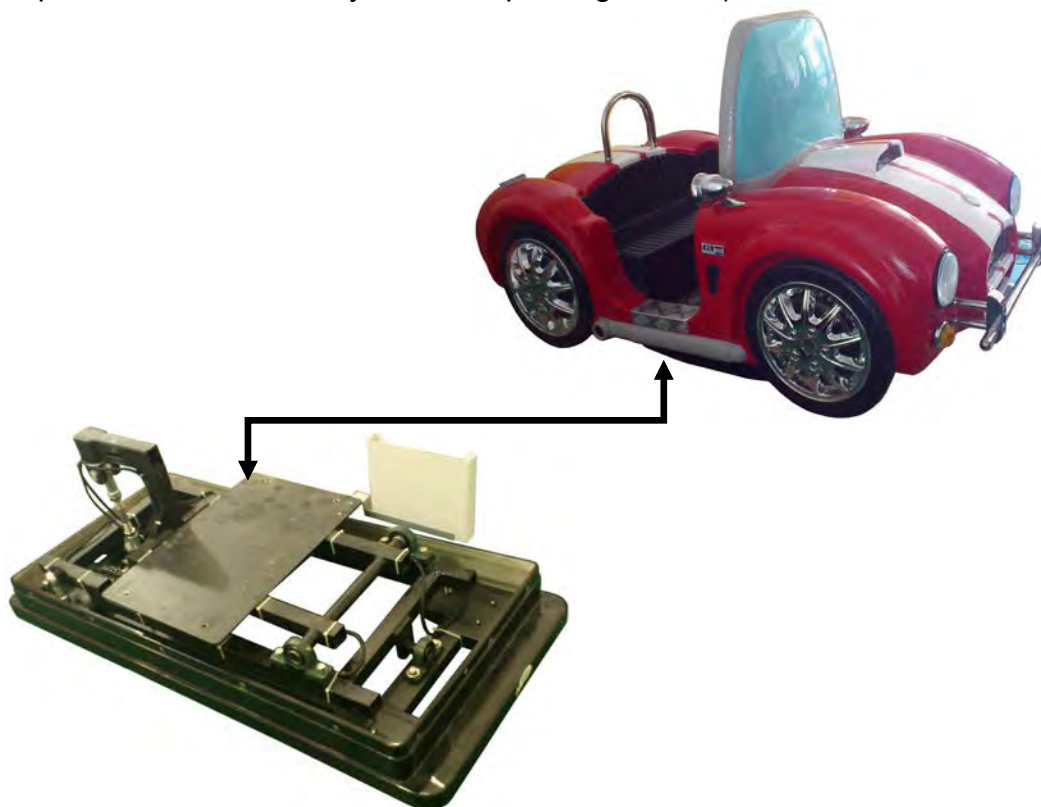

7. Service the base assembly mechanism and motor after removing the fiberglass car body.

⚠ NOTE:

- When fix fiberglass car is placed back on the base, you should carefully align the 4 screw holes on fiberglass step plate and the 4 screw holes on the base.
- Please use caution in connecting the connectors in the proper place.

8. CONTROL SIGNAL AND INSTRUCTION

8-1 PCB LAYOUT

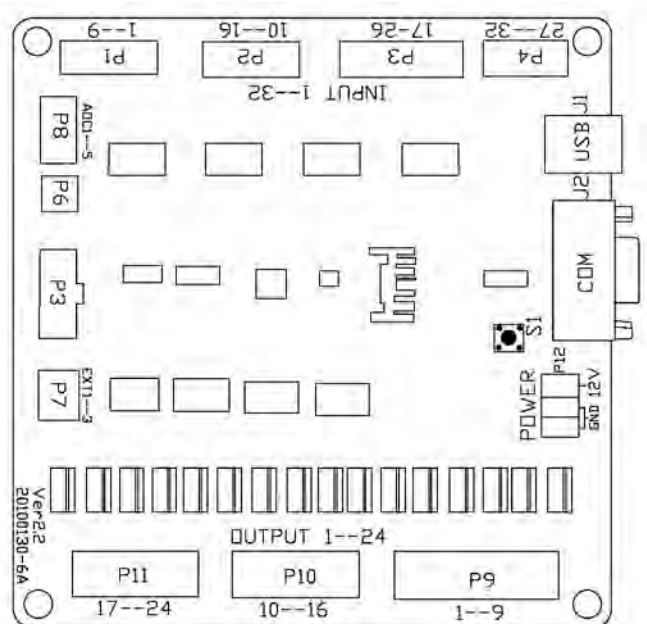
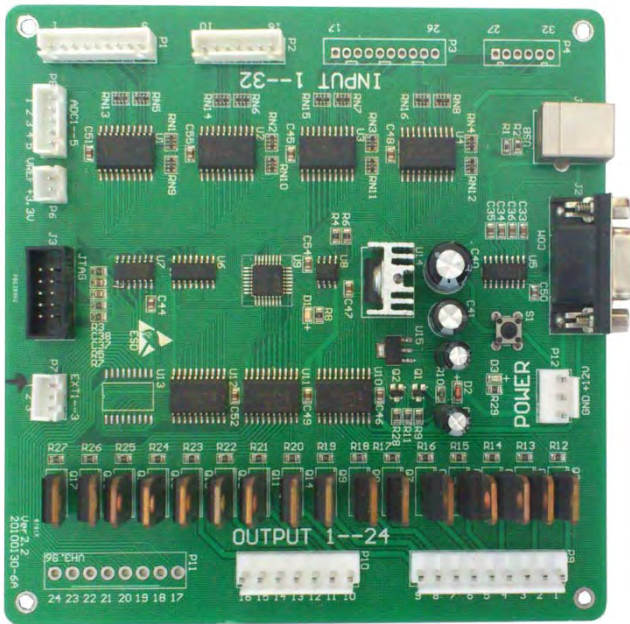

P1, P2, P3, P4 are for signal input port, P9, P10, P11 are signal output port, J1 is for USB , P12 is for power.

8-2 HOW TO ENTER INTO MENU

Open the coin door and you will see the Setting/Meter Panel at the top of coin box;



↓ To enter the Menu state on screen- Press: “MENU” inside the door on this Setting/Meter panel, then you will see the screen as below. Continue to press “MENU” until you highlight the word: “ENTER”. To enter the Menu state, then press “OPTION”. In the event you accidentally change the password, please enter the default password (default password is 0000).

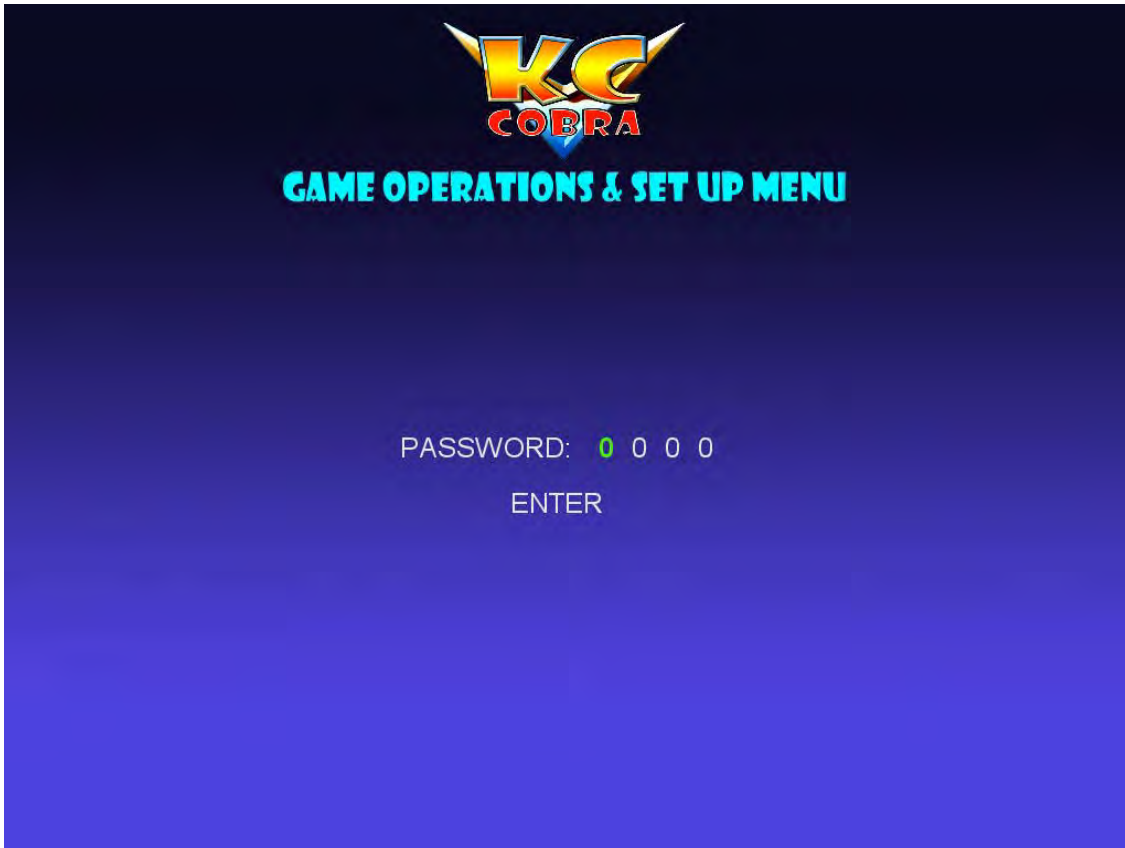

Figure 1

↑ After enter password, press “MENU”, move to ENTER, then press; “OPTION” to enter into next page (see figure 2)

Pressing “Menu” again and again advances through all of the various Menus available. Pressing “OPTION”, when in any given Menu, will highlight the Option desired and step through the options of that Menu.

When all of the Menu options are chosen- or at any time- the Operator simply can press the “JUMP” button and return to normal game play.

PRESS THE “JUMP” BUTTON ON THE CONTROL PANEL AT ANY TIME TO EXIT THE MENU EXCEPT IN THE TEST MENU!

EXIT THE MENU AND RETURN TO NORMAL GAME PLAY FROM ANY MENU SCREEN EXCEPT “TEST” BY PRESSING THE “JUMP” BUTTON.



Figure 2

↑ If desired, please set the desired password or leave at the default, 0-0-0-0.



Figure 3

CREDITS PER PLAY REQUIRED	1—8
AVERAGE GAME TIME	30 Sec—120 Sec
TICKET OPTION	ON/OFF
TICKET MECHANISM	ENABLE/ DISABLE
MERCY TICKET OPTION	0—8
TICKET TYPE	1PT/ 2PT
BONUS TIME OPTION	ON/OFF
BONUS TIME	5 Sec—30 Sec
BONUS TIME WON AT COINS COLLECTED	5—40
TURBO OPTION	ON/OFF
TURBO ITEMS PER GAME	1—5
TURBO TIME	5 Sec—30 Sec
ATTRACT MODE	ON/OFF
ATTRACT AUDIO	OFF/ 20—120
AUDIO LEVEL	1—10



**KC
COBRA**

GAME OPERATIONS & SET UP MENU

WHEN THE TICKET OPTION IS ENABLED, THE FOLLOWING TICKET OPTIONS MAY BE SET. TICKETS DISPENSED FOR COINS COLLECTED AT THE END OF GAME PLAY:

TOTAL COINS	0-10	11-15	16-20	21-25	26-30	31-35
TICKET OPTION 1	0	1	2	3	4	5
TICKET OPTION 2	0	2	4	6	8	10
TICKET OPTION 3	2	4	6	8	10	12
TICKET OPTION 4	4	6	8	10	12	14

Figure 4

EXIT THE MENU AND RETURN TO NORMAL GAME PLAY FROM ANY MENU SCREEN EXCEPT “TEST” BY PRESSING THE “JUMP” BUTTON.



GAME OPERATIONS & SET UP MENU

GAME TEST FUNCTIONS

HIGHLIGHT DESIRED TEST FUNCTIONS AND PRESS 'ENTER' FOR TEST

COIN MECHANISM

TICKET MECHANISM

DBA OPTION

STEERING WHEEL

ACCELERATOR PEDAL

'JUMP' BUTTON

LAMP TEST

BASE MOTOR TEST

AUDIO TEST

AUDIO 'DING' WHEN COIN ENTERED

DISPENSES ONE TICKET

SERIES OF AUDIO 'DING'S WHEN BILL ENTERED

TURN WHEEL LEFT and RIGHT LIMIT 'DING' AUDIO

PRESS FOR AUDIO 'DING'

PRESS FOR AUDIO 'DING'

ALL CONTROLLED LAMPS FLASH

OPERATES BASE MOVEMENT CYCLE



PLAYS MAIN BACKGROUND TUNE

Figure 5

EXIT THE MENU AND RETURN TO NORMAL GAME PLAY FROM ANY MENU SCREEN EXCEPT "TEST" BY PRESSING THE "JUMP" BUTTON.

9. INSTRUCTION OF GAME PLAY

9-1 GOAL ICONS

GOAL	IMAGE	FUNCTION
GOLD COIN		ADD SCORE, 1 POINT (TOWARDS TICKET REWARDS IF TICKET FUNCTION IS ENABLED)
OIL CAN		TURBO SPEED REWARD

9-2 HOW TO PLAY

Insert the proper Credits and the game will begin at various points throughout the course;



Step on the gas pedal to speed up the car. Control steering wheel to collect more coins and Turbo gas can, and to avoid obstacles.





Press “JUMP” button to collect the higher coin or to avoid all obstacles throughout the game. When the Time runs out, the game will end.



Tickets will be dispensed according to the total score after the game has ended. (Ticket version when enabled)

10. GENERAL TROUBLESHOOTING

Symptom	Possible Problem	Solution
	POWER	POWER
Sound Problems -No sound -Low Sound -Intermittent Sound	Low Volume Faulty speaker harnessing Faulty speaker Faulty sound board or sound board harnessing Faulty Main P.C. Board	Check Volume Control and adjust as necessary Check connections and/or repair harnessing Check and/or replace speaker Check connections or Replace Sound Board Check and/or repair or replace Main P.C. Board
Game does not take or credit money correctly	Coin switch out of adjustment Coin mech dirty or improperly adjusted Faulty Coin switch Faulty coin switch harness or connector Game improperly programmed Faulty Main P.C. Board or component	Re-form coin switch wire Clean and adjust mech as necessary Check and/or replace switch Check and/or repair harnessing Check programming options and adjust Repair and/or replace Main P.C. board
Ticket Dispenser not working properly, or no tickets being dispensed	No tickets in the game Tickets jammed in dispenser Ticket dispenser sensor blocked with debris Poor connection on the ticket dispenser Game improperly programmed Faulty ticket dispenser Faulty ticket dispenser harnessing Faulty Main P.C. Board	Refill ticket dispenser Clear ticket jam Clean off sensor Check and/or replace connectors Check ticket programming options Replace dispenser Check and/or repair harnessing Replace or repair Main P.C. Board
LED Light fail	Poor contact of terminal LED light is burned out. No voltage output form power box	Correct the connection Replace the broken LED light with new one. Replace with new power box
Game will not start.	Game power off Electrical Power Switch Open Main fuse blown Power Supply problem or failure Faulty P.C. board or component	Check on/off switch and power cord Close Electrical Power Switch Check and/or replace fuse as necessary Check Power Supply output and connections Repair and/or replace main P.C. board
Game stops or is stopped with nothing displayed in video monitor	The power connector is disconnected. Possible faulty connection or short circuit.	Reconnect the connector securely. Check all circuitry for faulty connections or short circuits.

11. PART LIST

11-1 BASE MECH ASSY

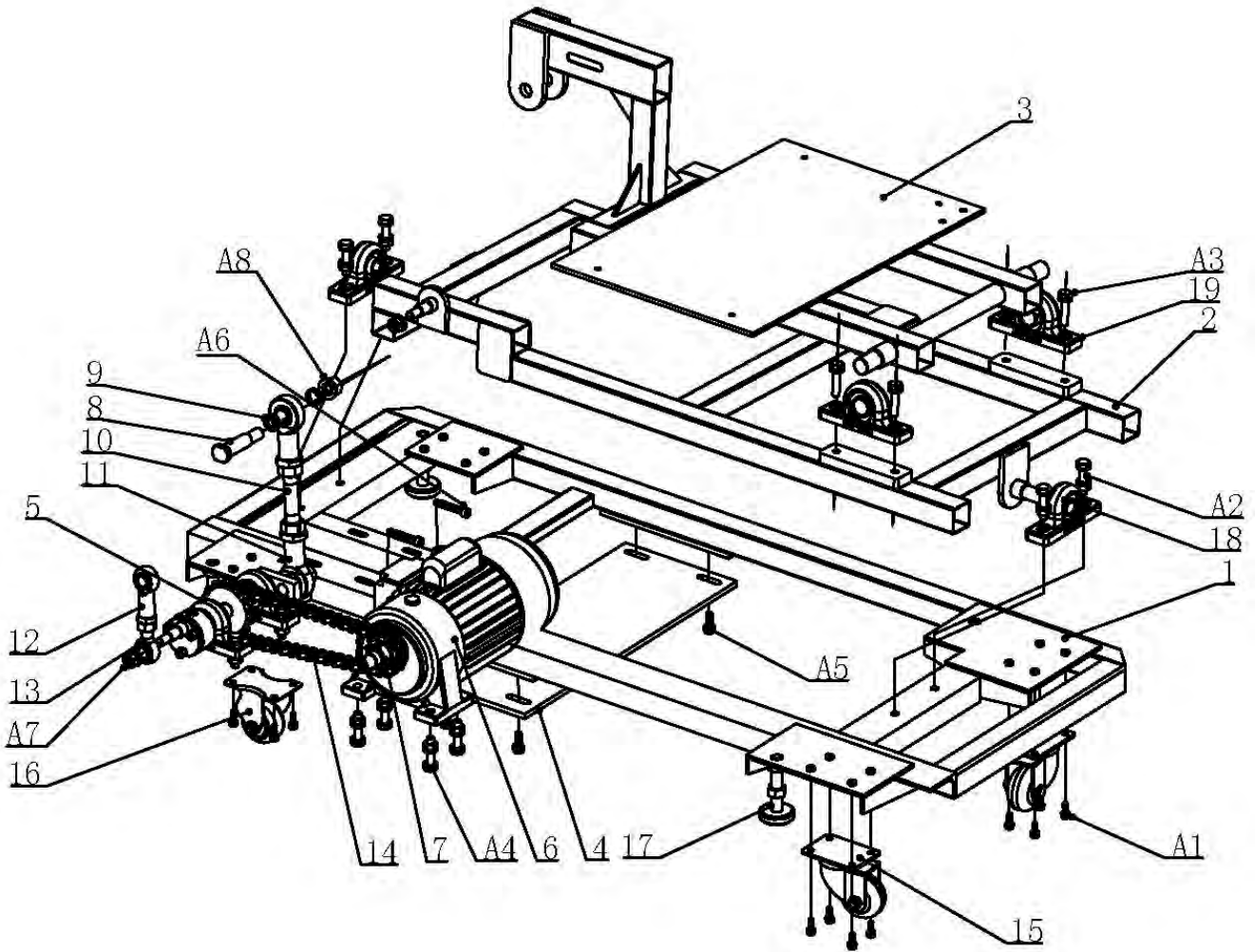





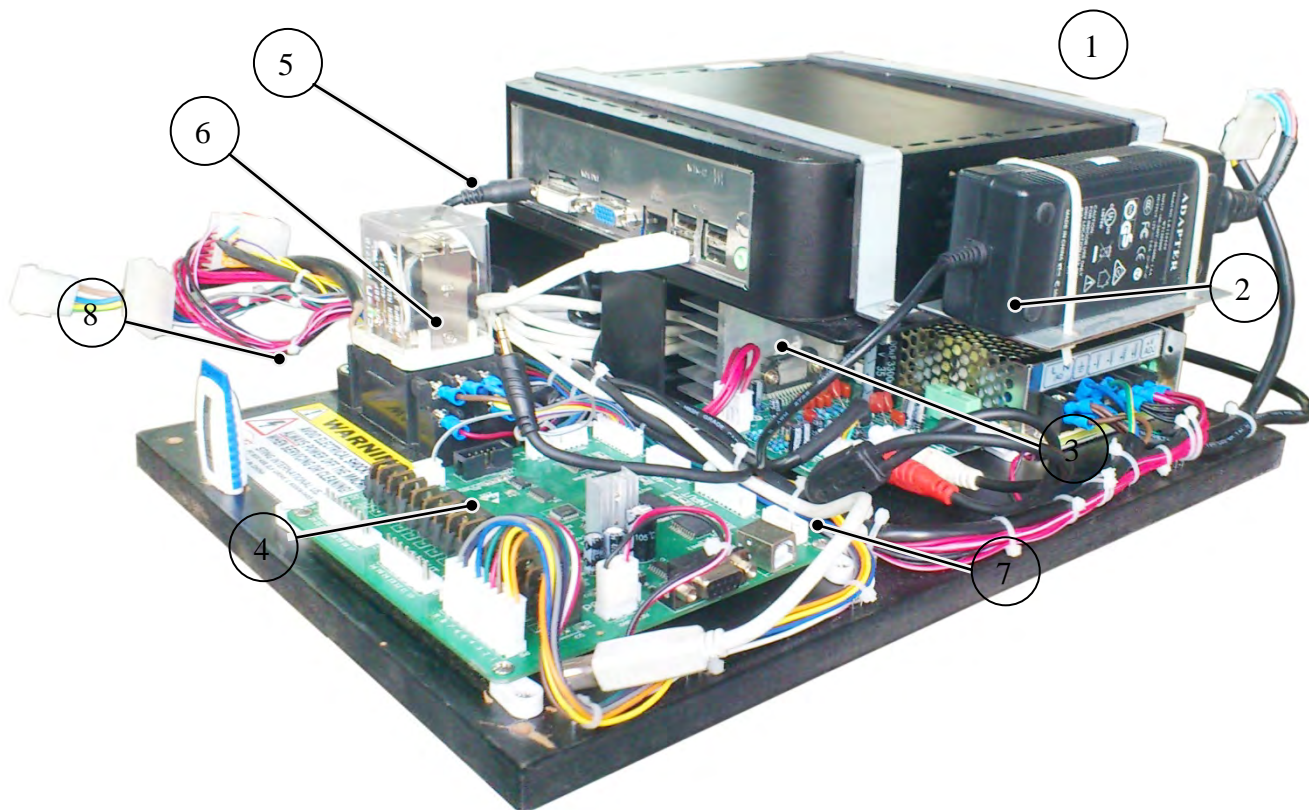

NO.	PART CODE FOR BASE FRAME	DESCRIPTION	QTY	SPECIFICATION	REMARK
1	COB-M-01	BOTTOM FRAME	1	Q235	
2	COB-M-02	MAIN MOTION FRAME	1	Q235	
3	COB-M-03	UP MOTION FRAME	1	Q235	
4	COB-M-04	PLATE FOR MOTOR	1	Q235	
5	COB-M-05	AXIS OF ROTATION FIXING ASSY	1	ASSY	
6	COB-M-06	MOTOR	1		
7	COB-M-07	MOTOR CHAIN WHEEL	1	45#	
8	COB-M-08	HINGE PIN	1	Q235	

9	COB-M-09	SLEEVE	2	Q235	
10	COB-M-10	PULL ROD	1	Q235	
11	COB-M-11	PLAIN BEARING	2	INSIDE TEETH M20	
12	COB-M-12	PLAIN BEARING	1	INSIDE TEETH M16	
13	COB-M-13	PLAIN BEARING	1	OUTSIDE TEETH M16	
14	COB-M-14	CHAIN (5 CHAIN)	1	23 KNOB	
15	COB-M-15	CASTER	2	2.5"	
16	COB-M-15	CASTER	2	2.5"	
17	COB-M-16	ADJUSTER	4		
18	COB-M-17	MOUNTED BEARING	4	UCP204	
19	COB-M-18	MOUNTED BEARING	2	UCP205	
A1	COB-M-19	OUT HEXAGON	16	M6X20	
A2	COB-M-20	OUT HEXAGON	8	M10X45	
A3	COB-M-21	OUT HEXAGON	4	M10X35	
A4	COB-M-22	OUT HEXAGON	4	M10X40	
A5	COB-M-23	OUT HECAGON	4	M8X25	
A6	COB-M-24	IN HEXAGON	2	M8X50 (WHOLE)	
A7	COB-M-25	NUT	2	212	
A8	COB-M-26	NUT	2	M16	

11-2 HARDWARE COMPONENT



NO	DESCRIPTION	QTY	SPECIFICATION/ MATERIAL	IMAGES
1	HOST COMPUTER	1		
2	POWER SUPPLY	1	OUTPUT12V/12.5A	
3	POWER AMPLIFIER BOARD	1	GC-2.2	
4	MAIN BOARD	1	Ver2.2 20100130-6A	
5	RELAY	1	LJQX-38F/40A	
6	RELAY BASE	1	LJQX-38F-11A	
7	FIXED PLATE	1	BLACK WOOD	
8	"U" disc	1		

11-3 MACHINE PARTS LIST

NO.	PART CODE	DESCRIPTION	LOCATION	IMAGES	QTY	UNIT
1	KCC-US-001	MAIN GAME HARD DRIVE PC	TRUNK		1	PC
2	KCC-US-002	MAIN CONTROL I/O PCB Ver2.2 20100130-6A	TRUNK		1	PC
3	KCC-US-003	MAIN POWER SUPPLY OUTPUT12V/12.5A	TRUNK		1	PC
4	KCC-US-004	POWER AMPLIFIER PCB GC-2.2	TRUNK		1	PC
5	KCC-US-005	RELAY AND BASE SETLJQX-38F/40A	TRUNK		1	PC
6	KCC-US-006	AUDIO CABLE Q-562A	TRUNK		1	PC
7	KCC-US-007	LINK CABLE USB Q-515	TRUNK		1	PC
8	KCC-US-008	VGA MONITOR CABLE FROM PC Q-550	TRUNK		1	PC
9	KCC-US-009	METER 6 DIGIT	INSIDE COIN MECH DOOR		2	PC
10	KCC-US-010	MENU/OPTION/TICKET CLEAR PUSHBUTTON RED	INSIDE COIN MECH DOOR		3	PC
11	KCC-US-011	LCD MONITOR 17inch,16:9/220V	INSIDE		1	PC
12	KCC-US-012	SPEAKER 8Ω/15W	INSIDE		2	PC
13	KCC-US-013	SPEAKER GRILL COVER BLACK	INSIDE		2	PC
14	KCC-US-014	COIN MECH	COIN MECH DOOR		1	PC
15	KCC-US-015	FILTER 10A	TRUNK		1	PC

16	KCC-US-016	POWER SIWTCH 250V/10A	TRUNK		1	PC
17	KCC-US-017	"JUMP" PUSHBUTTON AND GRAPHICS AND LAMP SET	CONTROL PANEL		1	PC
18	KCC-US-018	GAS PEDAL ASSEMBLY	FLOOR INSIDE		1	PC
19	KCC-US-019	PROTECTION SKIRT PVC BLACK	BOTTOM		2	PC
20	KCC-US-020	FRONT LAMP COVER LA8020B(CHROMING)	FRONT		2	PC
21	KCC-US-021	FRONT LAMP LED PCB	FRONT		2	PC
22	KCC-US-022	FRONT LAMP SET SQ-17 YELLOW	FRONT		2	PC
24	KCC-US-024	BACK LAMP SET SQ-17 RED	REAR		4	PC
25	KCC-US-025	BOOSTER AND FUEL ON DASH BOARD LED PCB	CONTROL PANEL		2	PC
26	KCC-US-026	SPEED METER ON DASH BOARD LED PCB	CONTROL PANEL		2	PC
27	KCC-US-027	LED PCB	CONTROL PANEL		5	PC
28	KCC-US-028	BACKUP MIRROR KT-421	TRUNK		2	PC
29	KCC-US-029	CHROMING WHEEL COVER ø364	TIRE POSITION		4	PC
30	KCC-US-030	ACRYLIC DASHBOARD (WITH GRAPHIC)	CONTROL PANEL		1	PC
31	KCC-US-031	MONITOR GLASS WITH GRAPHICS ;TEMPERING GLASS	MONITOR POSITION		1	PC
32	KCC-US-032	BACK BUMPER BAR;STAINLESS STEEL	REAR		1	PC

33	KCC-US-033	ROLL BAR; STAINLESS STEEL	TOP SEAT		1	PC
34	KCC-US-034	FRONT BUMPER BAR; STAINLESS STEEL	FRONT		1	PC
35	KCC-US-035	TICKET/DBV OPTION FRAME SET/DBV 门	LEFT OF MONITOR		1	PC
36	KCC-US-036	COIN BOX AND COIN MECH FRAME SET	RIGHT OF MONITOR		1	PC
37	KCC-US-037	FLOOR PLATE; DECORATION PATTERN	FLOOR AREA		1	PC
38	KCC-US-038	THRESHOLD STEP COVER RIGHT AND LEFT	ENTEANCE/EXIT		2	PC
39	KCC-US-039	GAS CAP;MIRROR SURFACE STAINLESS STEEL	TURNK		1	PC
40	KCC-US-040	MOTION LINKAGE FRAME BEARING UCP204	BASE FRAME		4	PC
41	KCC-US-041	MOTION LINKAGE FRAME BEARING UCP205	BASE FRAME		2	PC
42	KCC-US-042	MOTION LINKAGE JOINT BEARING M16(IN TEETH)	BASE FRAME		1	PC
43	KCC-US-043	MOTION LINKAGE JOINT BEARING M16(OUT TEETH)	BASE FRAME		1	PC
44	KCC-US-044	MOTION LINKAGE JOINT BEARING M20(IN TEETH)	BASE FRAME		2	PC
45	KCC-US-045	CYCLE CHAIN (23 KNOB)	BASE FRAME		1	PC
46	KCC-US-046	UNIVERSAL CASTER (2.5")	BASE FRAME		2	PC
47	KCC-US-047	DIRECTIONAL CASTER(2.5")	BASE FRAME		2	PC
48	KCC-US-048	ADJUSTER (M16)	BASE FRAME		4	PC

49	KCC-US-049	MOTION DRIVE MOTOR	BASE FRAME		1	PC
50	KCC-US-050	MOTOR CHAIN WHEEL	BASE FRAME		1	PC
51	KCC-US-051	DRIVEN CHAIN WHEEL	BASE FRAME		1	PC
52	KCC-US-052	MOTION BEARING	BASE FRAME		1	PC
53	KCC-US-053	ECCENTRIC BLOCK A	BASE FRAME		1	PC
54	KCC-US-054	ECCENTRIC BLOCK B	BASE FRAME		1	PC
55	KCC-US-055	GU0711	TRUNK		3	PC
56	KCC-US-056	DEEO GROOVE BALL BEARING 6202	TRUNK		2	PC
57	KCC-US-057	FLANGE BEARING 6901Z	TRUNK		1	PC
58	KCC-US-058	CLIP $\varnothing 15$	TRUNK		1	PC
59	KCC-US-059	DIRECTION PRESSURE SPRING	TRUNK		1	PC
60	KCC-US-060	BACK-MOVING BEARING	TRUNK		1	PC
61	KCC-US-061	DIRECTION SWITCH	TRUNK		2	PC
62	KCC-US-062	POWER CABLE	TRUNK		1	PC
63	KCC-US-063	TICKET MECH (OPTION)	TRUNK		1	PC
64	KCC-US-064	DBV (OPTION)	TRUNK		1	PC

65	KCC-US-065	COBRA HOOD EMBLEM	GRAPHICS		1	PC
66	KCC-US-066	LICENSE PLATE GRAPHIC	GRAPHICS		1	PC
67	KCC-US-067	NAMEPLATE GRAPHICS	GRAPHICS		2	PC
68	KCC-US-068	COOLING FAN WARNING	LABEL		1	PC
69	KCC-US-069	ELECTRIC SHOCK WARNING	LABEL		1	PC
70	KCC-US-070	GAS PENAL LABEL	LABEL		1	PC
71	KCC-US-071	MOVING PART WARNING	LABEL		1	PC
72	KCC-US-072	POWER SWITCH LABEL	LABEL		1	PC
73	KCC-US-073	SEIRIAL NO.	LABEL		1	PC

