



Customizing Family Fun™



SKU#: BG-CCL007

Catch the Light Combo

Instruction Manual

Assembly, Operation, and Care Instructions

Serial #: _____
Distributed By: _____
Sales Person: _____
Technical Service #: _____

Inspect Immediately after Transporting the Product

After receiving the shipment, inspect the product thoroughly to ensure that it has been shipped with care. Before turning the power on, please check the following:

- Check the cabinet for damage or shifting that may have occurred during shipping. Are there any dented portions or defects (cuts, etc.) on the external surfaces of the cabinet?
- Are all the legs intact?
- Do the power supply voltage and frequency requirements meet with those of the location (110V/220V)?
- Are all wires linked correctly and securely connected to each other? If coupled in an incorrect manner, the connection will not be made accurately and it could cause not only irreparable damage to the machine, but also is a potential fire hazard. **DO NOT INSERT CONNECTORS FORCIBLY.**
- Check that the all the cables, including power cables, are undamaged. Do power cables or other wires have any splices, cuts, or dents?
- Have you been provided with all of the associated accessories? Tip: Most of the pieces required to assemble the table are shipped within the table. Use your table keys to unlock the table and check parts for damage or other problems.
- Can all doors/lids be opened with the accessory keys? Can doors/lids be firmly closed? Does the coin box key open the coin box(es)?



Safety Instructions



- This equipment may contain hazardous voltage which can cause electrical shock. Only **qualified personnel*** should work inside the equipment.
*Note: Keep reading for a list of qualified personnel.
- To maintain personal safety and the safe operation of this product, read the entire manual before using it. The following instructions are intended for the users, operators, and the personnel in charge of the operation of the machine. **Be sure to keep this manual close to the product or in a convenient place for future reference.**



IMPORTANT NOTICE

- This product is intended for indoor use only
- This is NOT a child's toy; adult supervision is required for children to play this game. Children under 106 cm (roughly 3.5 ft) in height should not approach the table while it is in use, as this could be hazardous.
- Do not sit, climb, or lean on the table. Do not place anything, including people, on the top of the playfield surface.
- Do not drag the table when moving it, as this could damage the legs, cabinet beyond repair.
- Do not place any food or drinks on the table. Use the cup holders, if provided.
- This game features flashing lights which may not be suitable for photosensitive epilepsy.

Definition of Site Maintenance Personnel or Other Qualified Individuals



WARNING

Servicing and maintenance work of the contents herein stated should be performed by the *SERVICEMAN* stipulated as per IEC Standard. Those who do not have technical expertise and knowledge other than the *SERVICEMAN* are not allowed to perform the work herein stated. Executing the aforementioned work by such non-technical personnel can cause serious accidents that may endanger life.

Replacing parts, maintenance inspections, and troubleshooting should be carried out by **Site Maintenance Personnel** or other **Qualified Professionals**. This manual includes directions for potentially dangerous procedures which should only be performed by professionals with appropriate and specialized knowledge.

The **Site Maintenance Personnel** or other **Qualified Professionals** mentioned in this manual are defined as follows:

- **Site Maintenance Personnel:** Individuals with experience in maintaining amusement equipment, vending machines, etc., working under the supervision of the owner and/or operator of this product. Maintenance Personnel frequently service machines within amusement facilities or similar premises by carrying out everyday procedures such as: assembly, maintenance inspections, and replacement of units or replaceable parts.
 - **Actions Approved for Site Maintenance Personnel:** Machine assembly, maintenance inspection, and replacement of units or replaceable parts.
- **Other Qualified Professionals:** Personnel employed by the amusement equipment manufacturer. Personnel may also have been involved in design, production, testing, or maintenance of said amusement equipment. This individual should have either graduated from a technical school or hold similar qualifications in electrical, electronics, or mechanical engineering.
 - **Actions Approved for Other Qualified Professionals:** Assembly, maintenance, inspection, and replacement of units or replaceable parts for amusement equipment and/or vending machines, including repair or adjustments of electrical, electronic, or mechanical parts.

Before Using This Product

Please be sure to read the following before using this machine, in order to ensure the safe operation of this product. The following instructions are intended for users, operators, and personnel in charge of the operation and maintenance of the machine. After carefully reading and sufficiently understanding the warning displays and cautions, please handle the machine appropriately. Be sure to keep this manual for future reference.

Qualified Personnel: Only personnel who have technical expertise should perform the work stated herein to avoid hazardous situations. The instructions state that site maintenance personnel should be the only personnel performing work. Please perform maintenance work in accordance with the stated instruction; provided instructions for maintenance work are to minimize risk and prevent accidents. Failing to perform work as stated within the Instruction Manual may potentially be dangerous to both maintenance personnel and users.

- **Be sure to turn off the power before working on the machine.** To prevent electric shock, be sure to turn the power off before carrying out any work that requires direct contact with the interior of the product. If the work is to be performed in the power-on status, the Instruction Manual will state to do so.
- **Be sure to ground the Earth Terminal.** This is not required in the case where a power cord with earth/ground is used.
- **Ensure the power supply used is equipped with an Earth Leakage Breaker.** This product does not incorporate an Earth Leakage Breaker. Using a power supply which is not equipped with an Earth Leakage Breaker can cause a fire when or if earth leakage occurs.
- **Before installing the product, check for electrical specifications; the product must meet the requirements.** Ensure the product is compatible with the power supply voltage and frequency requirements of the location. Using any electrical specifications that are different from the designated specifications can cause a fire and/or electric shock.
- **Install and operate the product where appropriate lighting is available, allowing warning and safety labels to be read clearly.** To ensure customer safety, labels and printed instructions describing potentially hazardous situations are applied to places where risk for potential accidents are increased.

If any label is peeled off, apply it again immediately. Please contact Barron Games Technical Support at 1+716-866-0054 or email service@barrongames.com if you are in need of new stickers or parts. Visit www.BarronGames.com for more information about Barron Games' Parts and Service Department.

INSTALLATION AND MAINTENANCE SAFETY

This product is an indoor game machine. **Do not install it outside.** Even indoors, avoid installing it in the places mentioned below, so as to avoid causing a fire, electric shock, machine malfunction, or even death. Do not install or maintain this product in/on/within/near:

- places subject to rain or water leakage, places subject to high humidity, or in the proximity of an indoor swimming pool, shower, steam room, etc.
- places subject to direct sunlight, places subject to high temperatures, or in the proximity of heat dispensing units or portable heating devices.
- places filled with inflammable gas, within the vicinity of highly flammable or volatile chemicals, or other hazardous materials.
- dusty places.
- sloped surfaces.
- places subject to any type of violent impact.
- the vicinity of anti-disaster solutions, such as fire exits and extinguishers.
- places where the operating (ambient) temperature range is not 5°C to 30°C (41°F to 86°F).
- places near water or spray from water (such as a jet wash, hot tub, or swimming pool).

To ensure maximum safety for the users and service personnel, ensure that where the product is operated has sufficient lighting to allow all safety labels to be read clearly. Operation under insufficient lighting is not advised.



ASSEMBLY NOTES

1. Read this Instruction Manual carefully before assembling or playing.
2. Ensure that there is sufficient space to place and shift the product prior to assembly
3. Two strong adults are recommended to assemble the product.
4. Inspect and ensure all parts are securely attached before rotating the table.
5. Please Note: Children and pets should be kept away from assembly and game pieces; this table contains small parts and balls that could be a potential choking hazard.
6. This machine is supplied with a full range of accessories to help you get started right away. Key sets for 2 locks, a preinstalled SD card, 4 legs, and 12 leg bolts should be included with your table.



TOOLS NEEDED



- Catch the Light Combo Instruction Manual



- Ratchet or Wrench

*Note: Please retain the original packaging, so that it may be used for storage or transport later.

Assembly – Step 1 (Unpack the Game)



1. Place the machine near the desired location.



2. Remove the shrink/stretch wrap from the package.



3. Cut the safety belt. **Warning:** The safety belt is very taut and can harm you if it snaps back while you're cutting it. Use caution.



4. Cut the packaging tape and open the box and gently remove the Styrofoam spacers. Note: Your model table may be styled differently.

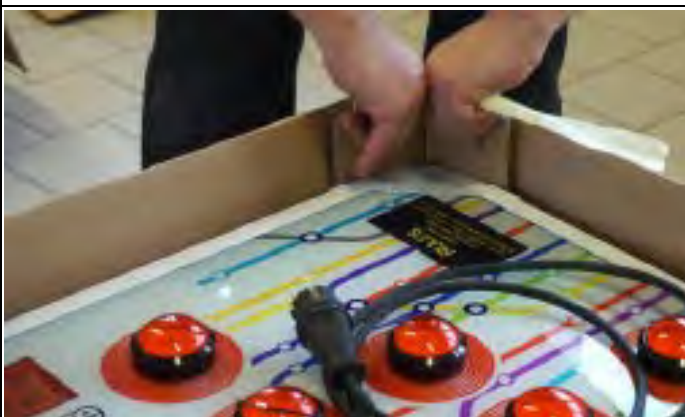

5. Remove the cardboard corner shields.



6. Cut down the corners of the cardboard.

Assembly – Step ② (Assemble the Table)



1. A set of keys will be taped to the top or bottom of the table, gently remove the tape and collect the keys. Each keyhole has a different key. Once turned the lock mechanism will pop open. The locks will remain unlocked until the mechanism is pushed back in.



2. Unlock the money box and remove it from the machine. Inside the box you will find a set of screws and a settings menu description (also included in instruction manual)



3. Open the machine. All 4 legs will be on the right hand side. Unscrew the 8 screws that mount the safety tape securing the legs inside the machine.



4. Remove the legs from the internal cabinet. Close the machine. Make sure that both locks are pushed closed and the keys are not inside the table.



5. Flip the machine so it stands on the side with the hinges. The locks should now be on the top of the cabinet.

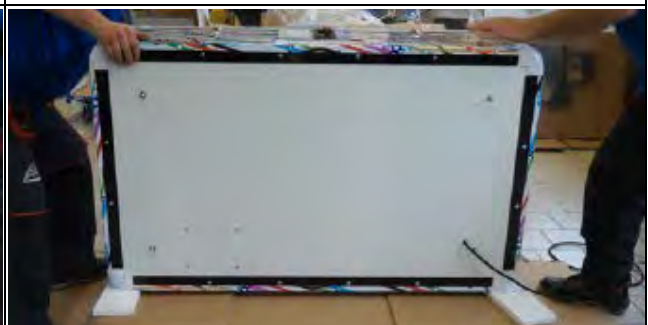

Assembly – Step ② (Assemble the Table)



6. Install the legs. Notice that one of the legs is different; there is an eyelet on the side. This leg goes on the side with the cord, the eyelet acts as a guide once the table is assembled.



7. To secure the bolt: place an expanded pad, a spring pad, then a nut. When tightening the nut, make sure that all the other holes on the leg are aligned with the holes on the table.



8. At this point, only use one mounting point per leg until the table is upright.



9. When all 4 nuts (one per leg) are tightly secured, flip the table back to the correct standing position.



10. Open the machine and insert the additional screws (two more on each leg) from **under** the table.



11. Place an expanded pad, a spring pad, and then the nut. Proceed to tighten all 12 mounting points (4 bolts from Step 7 and 8 from Step 10)

Assembly – Step ② (Assemble the Table)

12. Close the machine. Make sure that both locks are pushed closed and the keys are not inside the table.



13. Insert the money box back into the machine, close the lock and remove the key.



14. Cut the zip tie on the power cord being very careful not to cut or damage the cord.

15. Check to make sure the machine is not cold. If it is, wait an extra 30 minutes to warm it to room temperature before plugging in.



16. Connect the machine to the power outlet. It should start and be ready to program.

Assembly – Step ③ (Program the Game)

Operation Modes:

- | | |
|---|---|
| <ol style="list-style-type: none"> 1. OFF 2. Normal operation mode <ol style="list-style-type: none"> a. Standby b. Waiting for START c. Game | <ol style="list-style-type: none"> 3. Settings 4. Software update |
|---|---|

Software Regulated Features:

- | | |
|--|---|
| <ul style="list-style-type: none"> • Volume • Credit settings • Ticket dispenser settings • Free-play mode | <ul style="list-style-type: none"> • Button lit time • Lit buttons limit • Clear active credits • Default settings recovery |
|--|---|

Assembly – Step ③ (Program the Game)

How to Browse the Settings Menu:

Open the machine, press UP button on the main board to enter settings, close the machine.
 Use lit buttons to navigate and change settings.
 Press UP and DOWN to browse through settings, press ENT to enable value changing, change value with UP and DOWN, apply changes with ENT. Press ESC to exit settings.

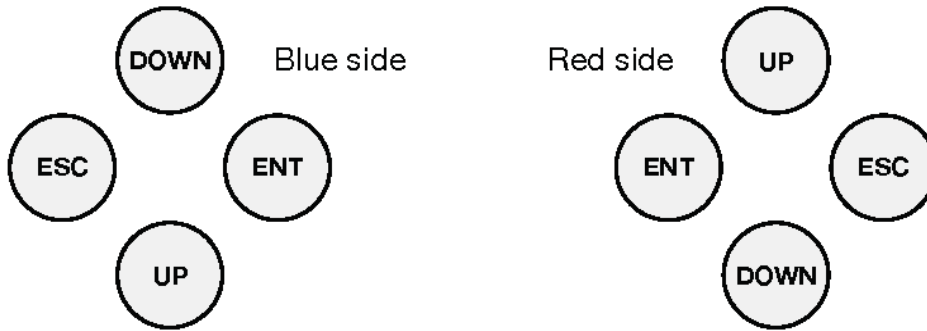

		Description
2		Money counter
4		Dispensed tickets counter
21	CAC	Coin acceptor communication (serial/parallel)
23	PL1	Credits quantity for one pulse on first channel of coin acceptor
24	PL2	Credits quantity for one pulse on second channel of coin acceptor (if used)
25	PL3	Credits quantity for one pulse on third channel of coin acceptor (if used)
26	PL4	Credits quantity for one pulse from bill acceptor
41	VPL	Machine volume
43	Lo1	Level 1 button lit time
44	Lo2	Level 2 button lit time
45	Lo3	Level 3 button lit time
46	NoL	Number of lit buttons at the same time
48	FrE	Free play mode
61	tDt	Ticket dispenser mode (continuous /pulse)
62	Ti1	Tickets for winner *
63	Ti0	Tickets for loser *
64	TiR	Tickets for record
65	GAr	Free games for record
66	PT1	Extra tickets - first stage point threshold **
67	nT1	Extra tickets - first stage ticket quantity **
68	PT2	Extra tickets - second stage point threshold **
69	nT2	Extra tickets - second stage ticket quantity **
70	PT3	Extra tickets - third stage point threshold **
71	nT3	Extra tickets - third stage ticket quantity **
72	PT4	Extra tickets - fourth stage point threshold **
73	nT4	Extra tickets - fourth stage ticket quantity **
81	CrE	Clear active credits
82	bSt	Clear best score
83	dFL	Restore default settings

Assembly – Step ③ (Program the Game)

How to Browse the Settings Menu:

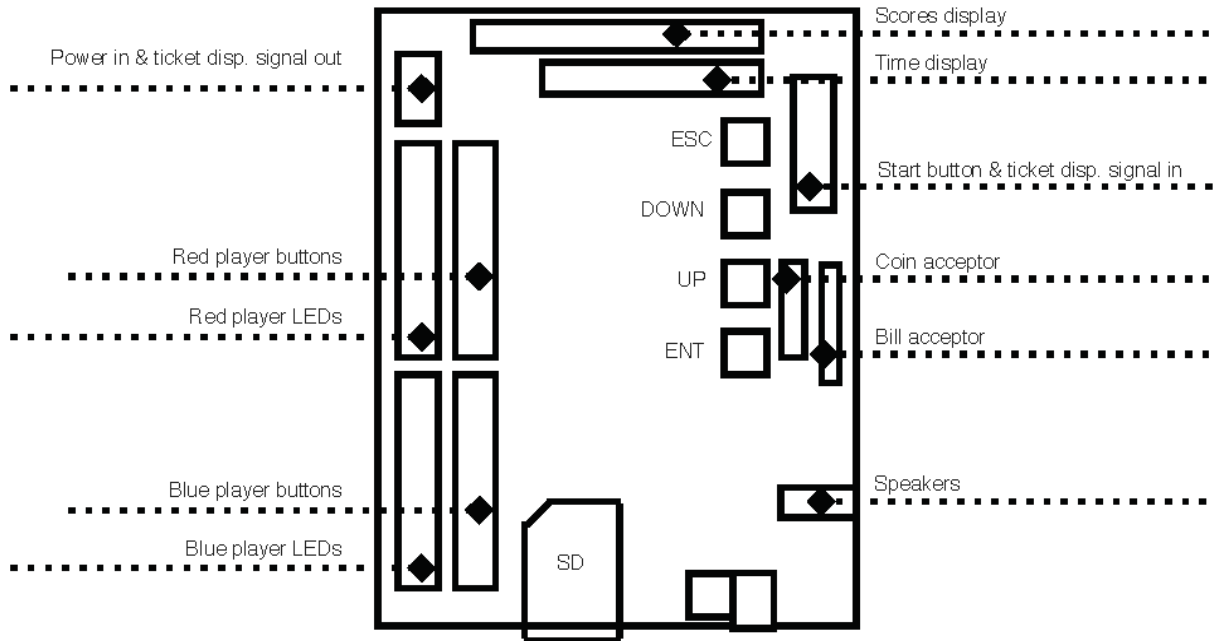

Notice: if machine runs out of tickets while dispensing them, open the machine, insert more tickets and press ESC on the main board to resume dispensing tickets.

Warning: Making adjustments or performing procedures other than those specified in your equipment's manual may result in hazardous electric shock.

Warning: The wiring system in the machine is under voltage that is safe in normal use but may be harmful while improper use. For your safety, have all electrical equipment serviced only by an Kriss-Sport Authorised Service Provider.

Technical Support

E-mail: service@barrongames.com

Phone: +1 716-866-0054

CatchTheLightCombo

* - Set ticket quantity that winner and loser will get when the game is over.

** - Set point threshold and ticket quantity to reward players for reaching high scores.

Assembly – Step ③ (Program the Game)

How to exit the settings and apply the changes:

- | | |
|--|---|
| 1. All values are stored immediately after making changes. You don't have to reboot the machine in order to apply changes. | 2. Browse menu using the UP and DOWN buttons.
3. To exit the menu, press ESC or restart the machine. |
|--|---|

How to read counters:

Counters can display large numbers (up to 6 digits) and are using both **score displays**. For example, when reading tickets counter, you may see:

- 002 on the left display
- 491 on the right display

This means that the machine gave 2,491 tickets. The number on the “credit display” is just an order number of this settings menu position and it's not relevant to the counter value.

How to adjust the volume level:

- | | |
|---|---|
| 1. Turn ON the machine and wait for normal operation mode.
2. Open machine and locate main board.
3. Use UP to navigate to position VPL in settings menu. | 4. Press ENT and use UP and DOWN buttons to adjust volume value.
5. After adjusting press ENT to confirm new setting.
6. Press ESC to go back to normal operation mode. |
|---|---|

How to replace the SD card:

- | | |
|--|---|
| 1. Turn the machine OFF, open the cabinet, and locate the SD card on the main board.
2. Press the card and it will pop out of the socket.
3. Pull the existing card out. | 4. Insert the new card securely.
5. Close the machine and turn it off. |
|--|---|

How to update the SD card:

- | | |
|--|--|
| 1. Turn the machine ON and check the current software version on the credit display. Version number is displayed only when the machine is initializing.
2. Turn the machine OFF, open the cabinet, and locate the SD card on the main board.
3. Press the card and it will pop out of the socket.
4. Pull the existing card out.
5. Connect the card to your computer using a card reader or insert it directly into a computer with a built-in reader.
WARNING: Do not use MAC OSX. Macintosh operating system creates hidden indexing files and all connected drives. Those files can corrupt the main board.
NOTICE: Make sure your card reader is high quality and the USB cable can power the reader. Some low-quality card readers need additional power supply to work correctly. | 6. Check if the SD card is an old .hex file. If so, select the file and move it to the trash bin.
7. Move a new .hex file onto the card. (Note: a new .hex file can be requested via service@barrongames.com)
8. Use your operating system hardware removal tool to safely remove the SD card from the reader. Remove the SD card.
9. Put the SD card back into the socket on the main board of the game.
10. Turn on the machine and wait for the update procedure to complete.
11. When updating the displays on the table will read „BOOT” then „ENDBOOT” and finally „INIT”
12. After initializing, the machine will start normally. |
|--|--|

Assembly – Step ④ (Operating the Game)

How to Play the Game:

1. **Insert payment and choose an end to play.** (Skip this step if set to FREE PLAY)
2. **To play one player:**
 - a. Press the illuminated start button on the players left.
 - b. Wait for the countdown to begin. The game will give you a few moments to allow a second player to join.
3. **To play two player versus:**
 - a. Press the illuminated button on the players far left.
 - b. Players will have 5 seconds (countdown on the table top) to press start on the other side of the table.
 - c. Once both players have joined the game, a new countdown will start, after a few moments, the first round will begin.
4. **Game Objective:** Press all the lit buttons until the time in each of 3 rounds runs out. Game difficulty can be set by the operator.
5. **When the Combo Bonus button is lit:** quickly hit it for a cumulative bonus point reward at the end of each round.
6. **If a non-lit button is pressed:** points will be deducted from that players score.
7. **Play 3 Rounds:** there will be a few second pause in between each of three rounds.
8. **Tickets are rewarded at the end** of the third round when the game is over. Redemption is optional and ticket redemption option settings can be changed in the settings menu.

After Installing the Game

1. Check the voltage regularly to avoid a short circuit or potential fire. Do not overload the circuit.
2. Keep the power cord out of areas with busy foot traffic to ensure the safety of users and the machine.
3. Keep children away from all power sources and power supply units. Children should always be under adult supervision while using the machine. Youth under 120cm (roughly 4ft) in height should not operate this machine.
4. Regular maintenance should be performed on the machine to ensure that it is clean, smooth, and debris-free (see section "Care and Maintenance").
5. Do not use any sharp instruments on any part of the machine as it may cause irreparable damage.
6. Remove and replace any piece or part that becomes damaged.
7. Turn off the game and have it inspected by an electrician or service technician if it is operating abnormally.
8. Contact an electrician or service technician if your product experiences the following:
 - Power Failure
 - Liquid or Objects Found Near/Inside Electronic Components
 - Abnormal Sounds Coming from the Cabinet
9. Use caution while transporting.
10. Do not use outdoors or in damp areas.
11. Take extra care when handling the glass surface.

Care and Maintenance

1. Always connect the machine to a grounded electrical outlet.
2. Always turn OFF the power and unplug the power supply to the game before opening or replacing any parts. When unplugging the machine from an electrical outlet, grasp the plug, not the cord.
3. **Caution:** Always use digital multimeter, logic tester, or oscilloscope for testing integrated circuits. Do not connect or disconnect any of the integrated circuits while the machine is ON. Do not install any fuse that does not meet the specified rating.
4. Use a soft cloth and product-specific polishing spray to clean the cabinet and play surface. Household window cleaner may be used to clean the top of the game (glass surface). Do not apply cleaner or any other liquid directly onto the machine, instead, apply it to the cloth and then wipe the surface. We've found that a microfiber cloth works great to remove dirt and fingerprints with ease.
5. Dust, grime, and other debris can collect inside the body of your table over time. Vacuum out the inside cavity frequently. The easiest way to access the inside of the table is to unlock both locks and lift the top of the cabinet like a trunk. It should stay open once it has reached maximum height. Opening the cabinet will also give you access to excess dust that may have built up inside the machine over time. **NEVER ATTEMPT** to clean the cabinet while the game is operating.
6. Clean any dirt or debris from the main PC Board with a soft brush or dry cloth. **NEVER USE WATER OR OTHER LIQUIDS.** Always be sure to turn off or unplug the machine before opening the PC Board panel.
7. Periodically check the functionality of the coin mechanisms and empty coin boxes.
8. If applicable, check the functionality of the ticket dispensers and restock.
9. Perform maintenance work in accordance with these instructions. **Be sure to always turn off the power before servicing the machine.**

Troubleshooting

Having trouble assembling your new table?

Call our experts in the Parts and Service Department (1+716-866-0054) or email Service@BarronGames.com and we will be happy to assist you!

Machine Won't Turn On:

1. Check if the power outlet is working correctly.
2. Check if the power supply inside the machine is functioning (a green LED will be illuminated).
3. Check if the power in connector is connected correctly to the main board.

No Sound:

1. Check to make sure the volume setting is not set to 0.
2. Check to see if the speakers are connected correctly to the main board and connectors are secured properly to each speaker.
3. Check if SD card is plugged in correctly.
4. Check if files on the SD card are in the top directory and have corec names (game_sta.mp3, game1.mp3, - game5.mp3, winner.mp3)

Need to Fix and Replace a Button:

For step-by-step video instructions visit: <https://youtu.be/Taq6kUH6g0M>.

1. Unmount the switch with LED from the button from below.
2. Unscrew the nut from the button. The nut may be glued to prevent self-unscrewing
3. Push out the button from below.
4. Check if the button cover is broken; if so, replace it.
5. Squeeze two plastic elements to release inner element and push it out. Notice that the spring is most likely to jump out. Try to grab it before completely removing the inner element.
6. Push the spring and squeeze the white plastic elements to block it from popping out. Then place the inner element in the new button cover.
7. Put the soft washer on the button and install the button back in the glass.
8. Screw the nut back in and tighten it.
9. Install the switch with the LED back inside the button.

Need to Replace Switch and Switch Adapter:

For step-by-step video instructions visit: <https://youtu.be/J8ccAI7JeJY>.

1. Turn the switch counter-clockwise to remove it from the button.
2. The old button and the new button may have different switch adapters and different mounting systems.
3. The old button has the lock and switch adapter with locking pins. The new button will have locking pins and a switch adapter with a lock.
4. When changing the switch adapter, start with removing the LED.
5. Bend the adapter in order to remove the switch.
6. Place the switch in the new adapter and bend it again to lock it in position.
7. Plug in the LED and insert it back into the button chamber.
8. The new adapter will only work with the new buttons. It will not fit the old buttons. Old adapters will only work with old buttons and not fit the new buttons.

Need to Upgrade Button Backlight (make brighter):

For a step-by-step video instruction visit: <https://youtu.be/FDosX-on5rA>.

1. Remove the switch and take the LED bulb out.
2. Squeeze the two plastic parts together to remove the button. Don't forget about the spring inside. Remove the spring as well.

Electronic Diagrams

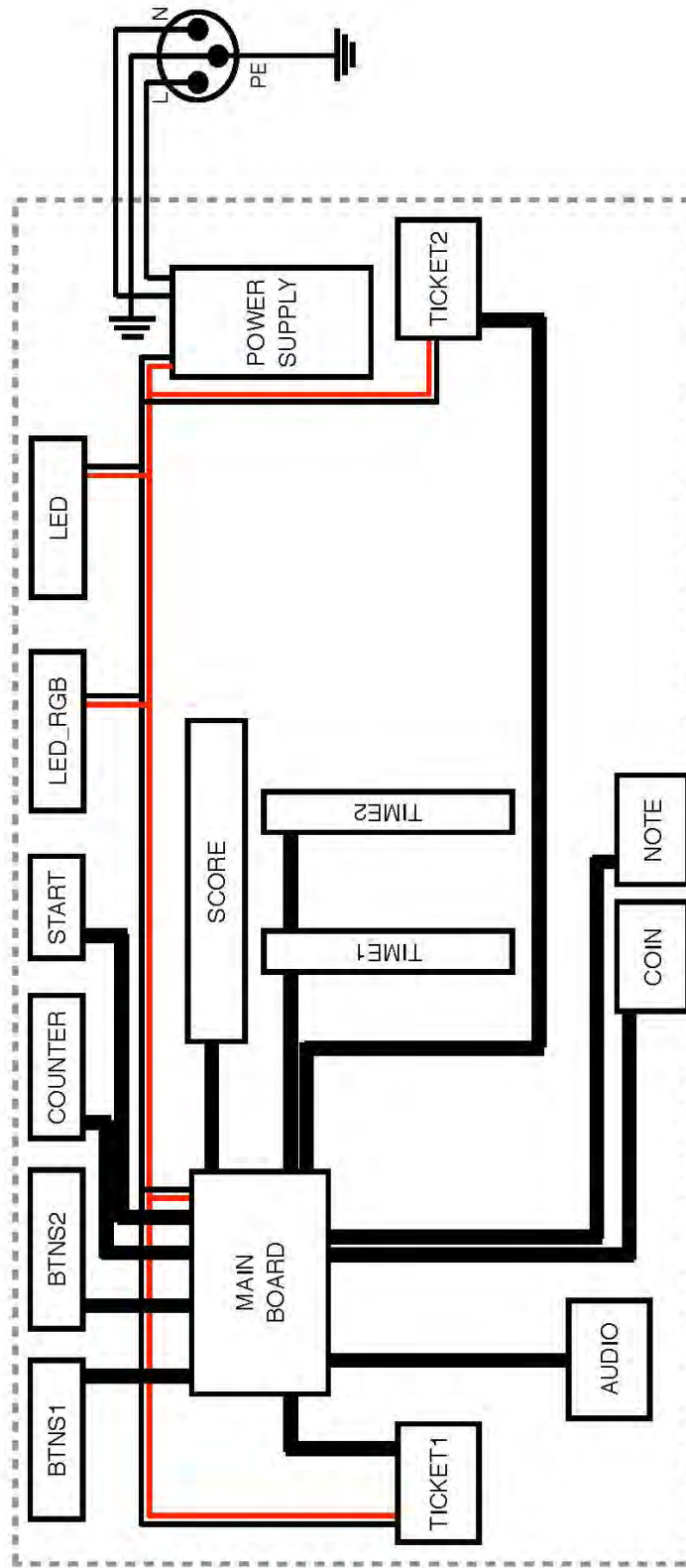

Electronic Diagrams

Main board

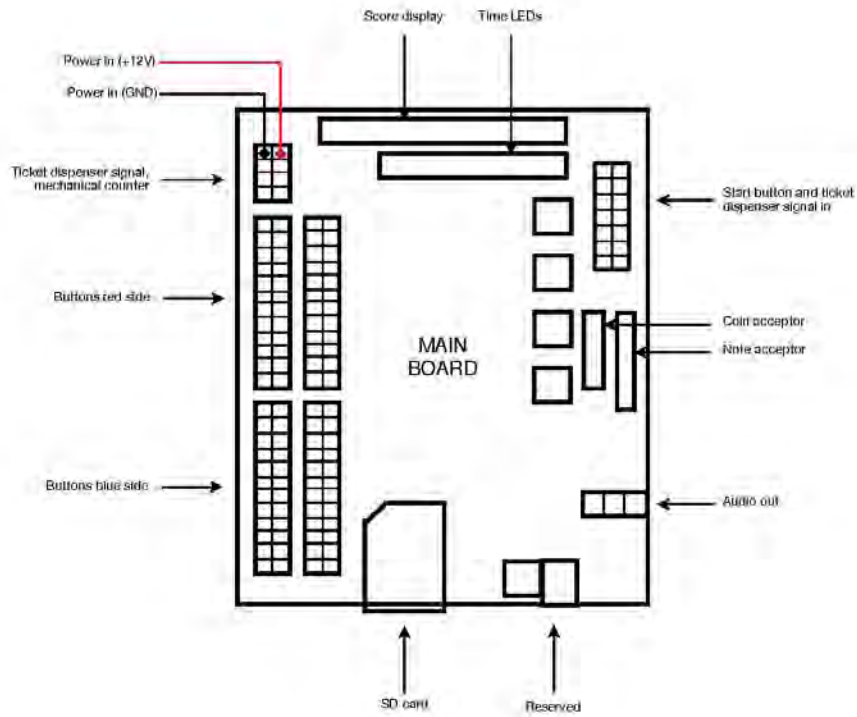

Buttons

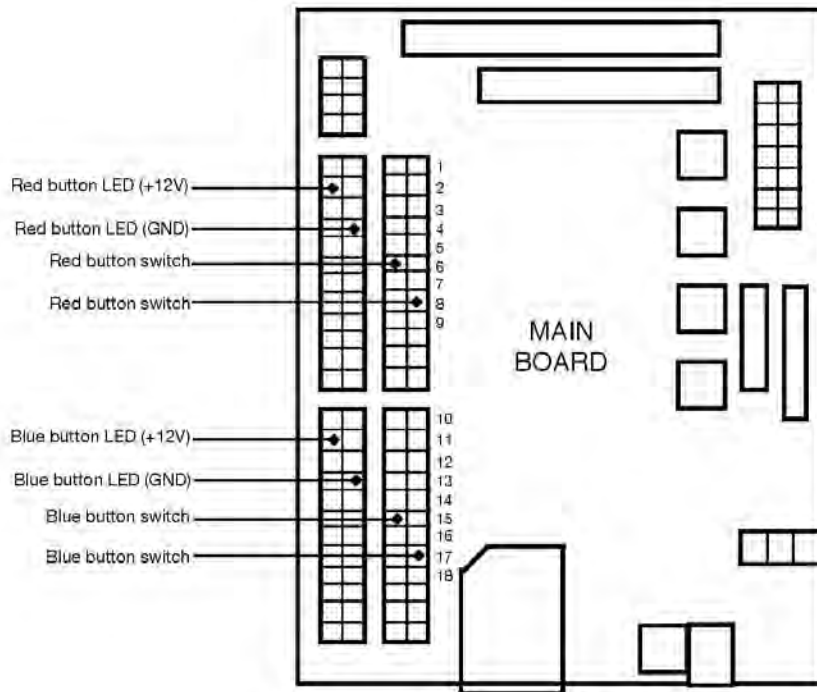

Electronic Diagrams

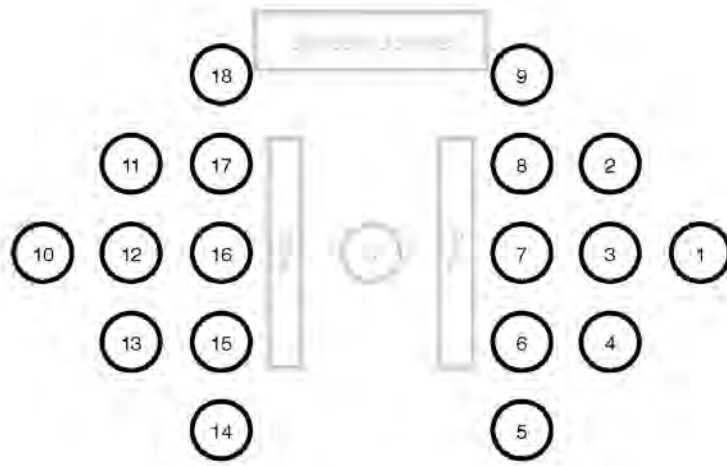
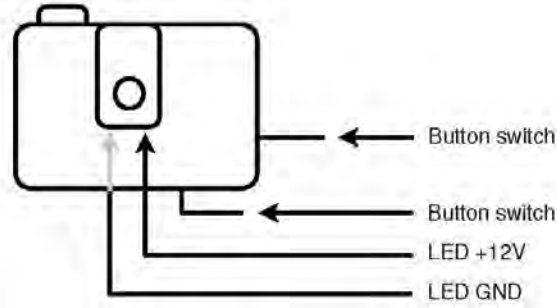

Counter

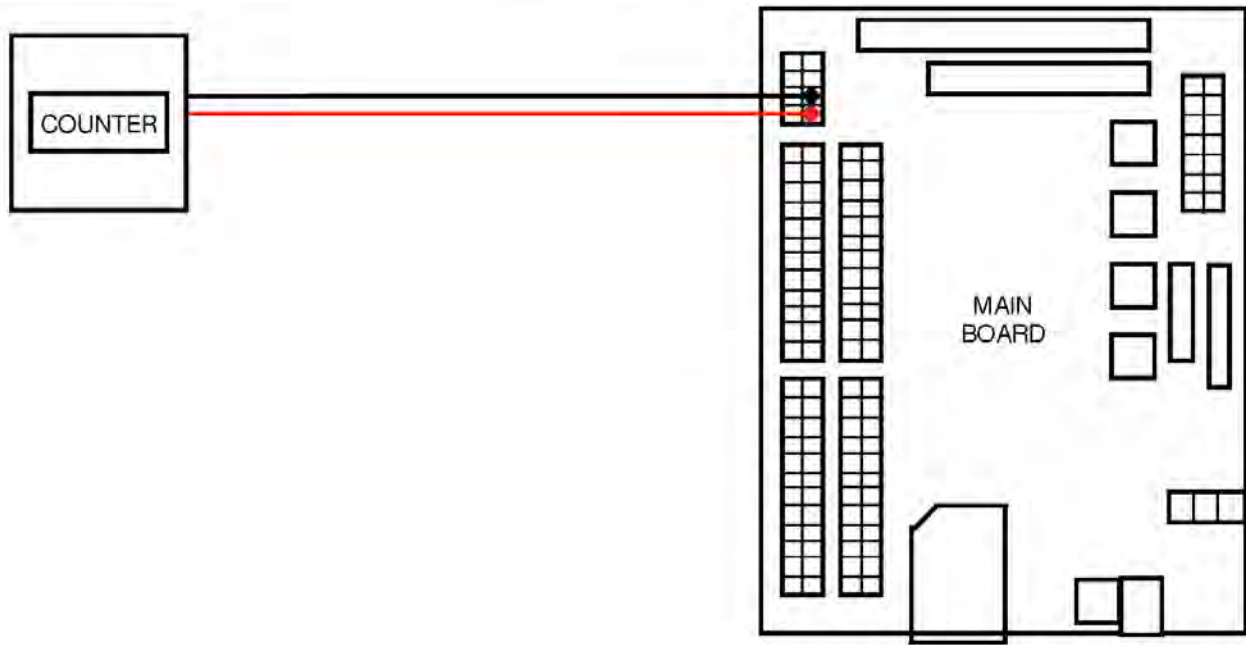

Electronic Diagrams

LEDs

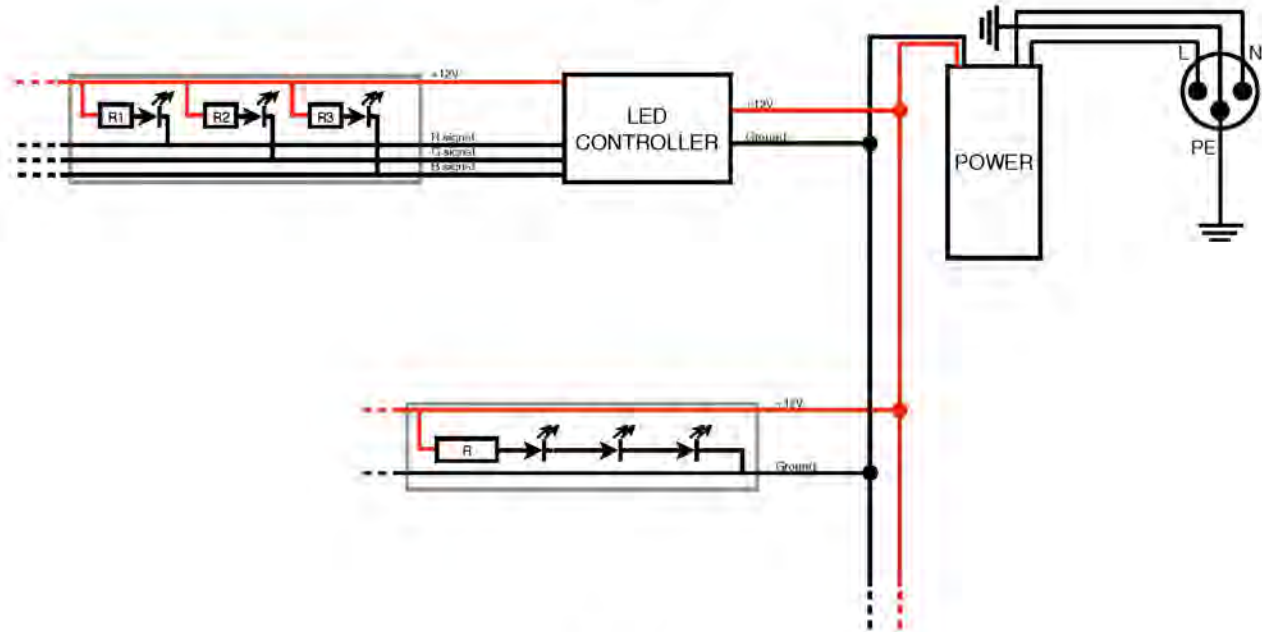

Displays

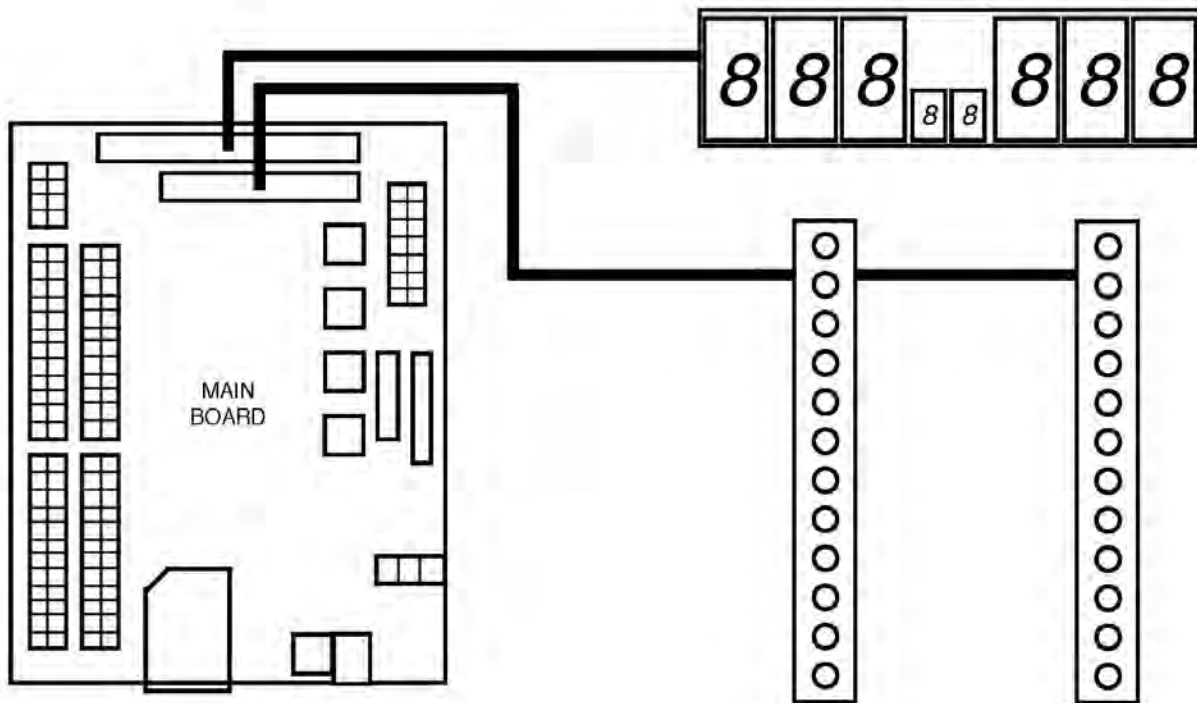

Electronic Diagrams

Ticket dispensers

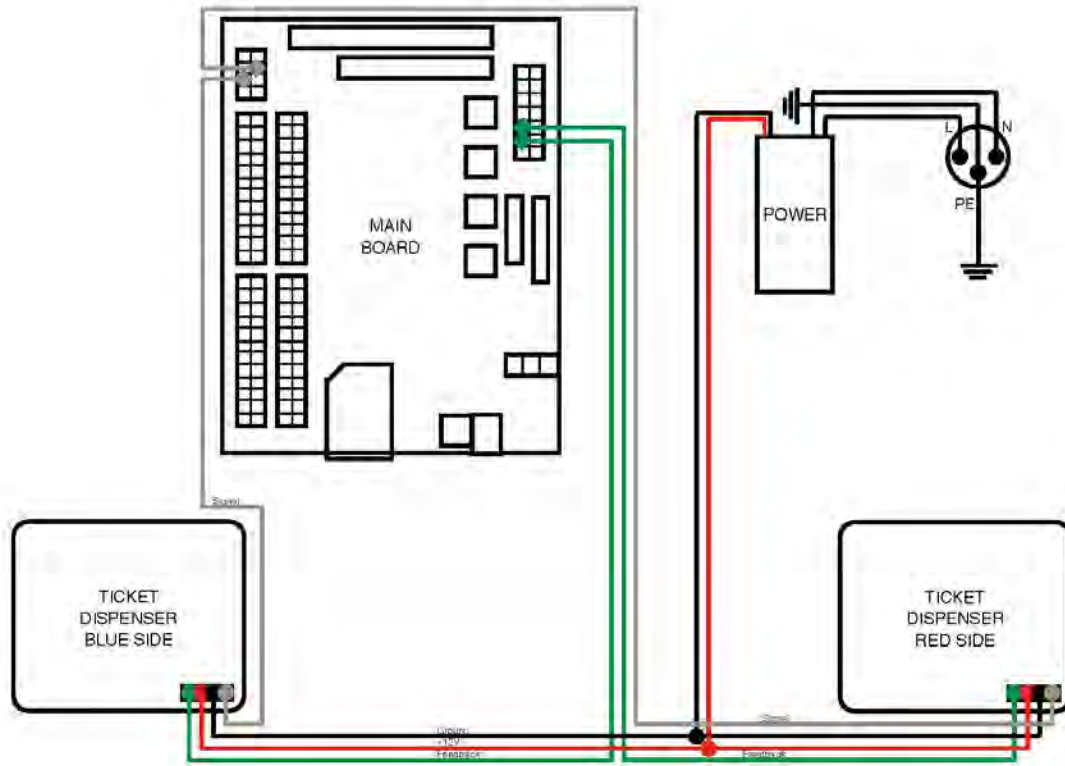

Speakers



Electronic Diagrams

Acceptors

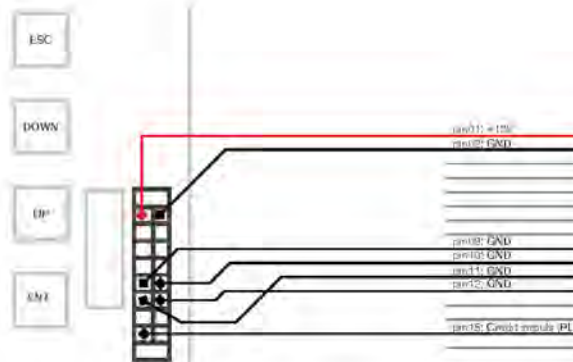
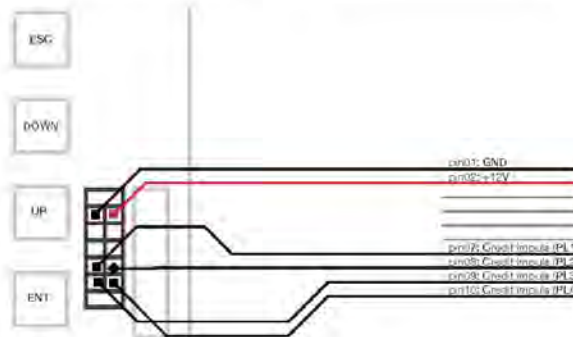
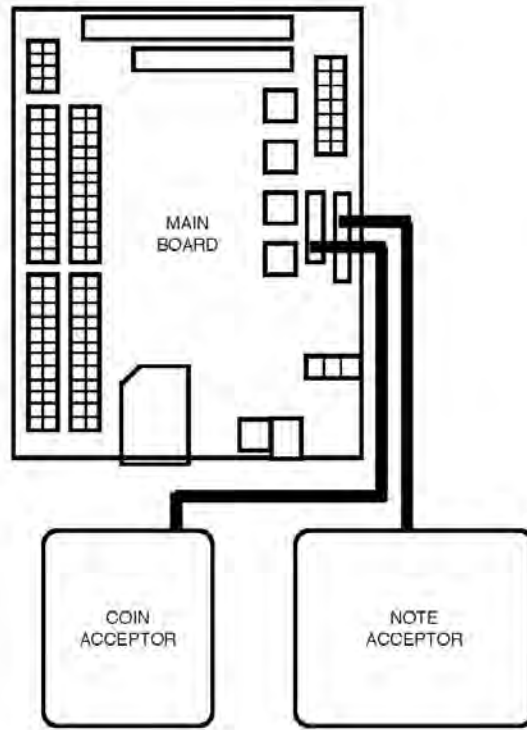

Parts List: Catch the Light Combo

SKU# BG-CCL007

Part#	Description	Photo	Part#	Description	Photo
CTL001	Player button (red or blue)		CTL010	Locks set (1x money box, 2x top frame)	
CTL002	Start button		CTL011	Power cord (3m/10ft long)	
CTL003	Button switch		CTL012	Power cord (5m/16ft long)	
CTL004	Button LED bulb		CTL013	Plastic corner cover (large, bottom)	
CTL005-A	Power source (75W)		CTL014	Plastic corner cover (small, top)	
CTL025-B	Power source (80W)		CTL015	Coin acceptor (electronic, Taiwan)	
CTL007	Buttons wiring (one side, left or right)		CTL016	Coin acceptor (Comestero)	
CTL008	Score display		CTL017	Bill acceptor (BV20)	
CTL009	Time displays set		CTL018	Ticket dispenser (Taiwan)	

Parts List: Catch the Light Combo (Continued)

SKU# BG-CCL007

Part#	Description	Photo
CTL019	Ticket dispenser (Entropy, pulse mode)	A photograph of a rectangular metal ticket dispenser with various components and wiring visible on its surface.
CTL020	Ticket box	A photograph of a blue, U-shaped plastic tray or box used for holding tickets.
CTL021	Main board	A photograph of a green printed circuit board (PCB) with various electronic components and connectors.
CTL022	SD card	A photograph of a black SD memory card.
CTL023	RGB LED driver	A photograph of a small electronic component with a white cable attached, likely an LED driver.
CTL024	Speaker	A photograph of a circular black speaker with a visible driver and a metal grille.



Customizing Family Fun™

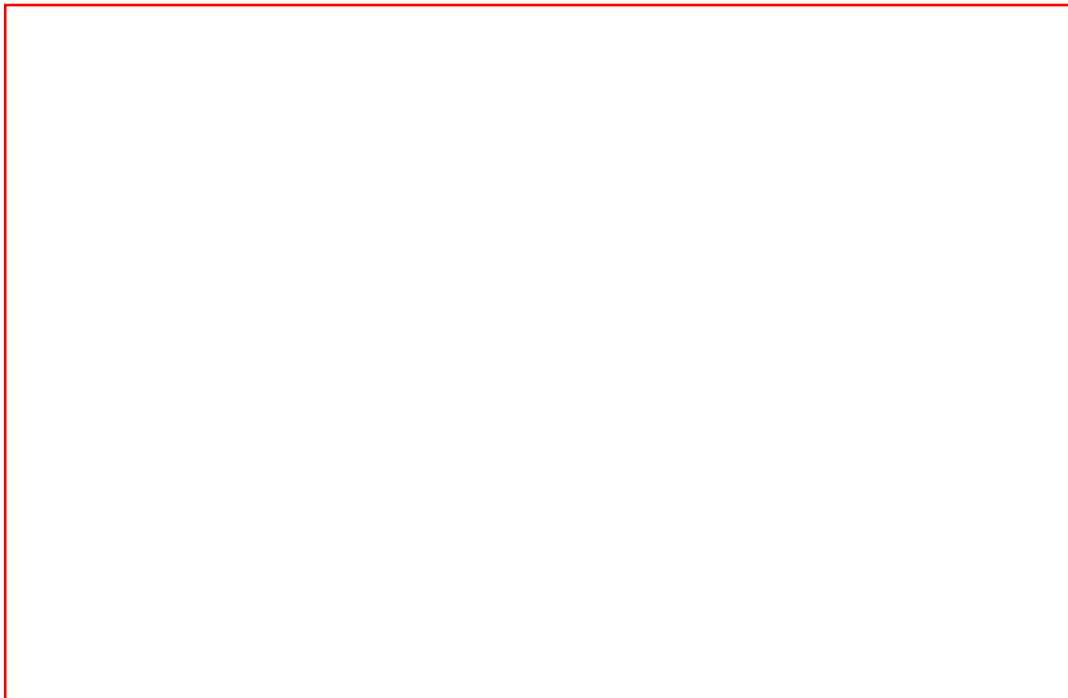

For Parts and Service, please contact us:

phone: 1+716-866-0054

email: Service@BarronGames.com