

USER MANUAL OF “KING OF THE HAMMER”



- * How to play: traditional arcade game requiring you to hit strongly to get the highest score when the hitting plate goes up
- * Photo is subject to change and may be different from actual product

Contents

1. Precautions

- What to check when you receive the product
- Note for installation
- Notes for transference

2. Specifications

3. Product Composition & Name of Each Part

- Composition
- Inside
- Inside of Hitting Plate

4. Sort of PCB and Circuit Diagram

5. How to Control and Set the Mode

6. Part List

7. Trouble Shooting & Maintenance

8. How to Assemble

1. Precautions

Immediately after receiving the product

Make sure operating voltage and power consumption are the same as specifications of location. Incorrect use may cause malfunctions.

Notes for installation

A technician must install the product.

Please, follow the instructions carefully.

To avoid fire and electrical shock, use proper interior wiring and do not overload any one electrical outlet.

To avoid injury, do not expose the power cord to high traffic areas where it can be stepped and/or tripped on.

Notes for transference

When transferring the product, do not damage the power cord. This could lead to a malfunction or accident.

To avoid sustaining damage to product and causing possible malfunction, package product tightly when transferring, as to not allow it to shift and/or move during transfer.

2. Specifications



- Power requirements: 110V or 220V
- Power rating: 150W
- Dimensions: W550 X D900 X H2350
- Weight: 140kg

3. Product Composition & Name of Each Part

Composition

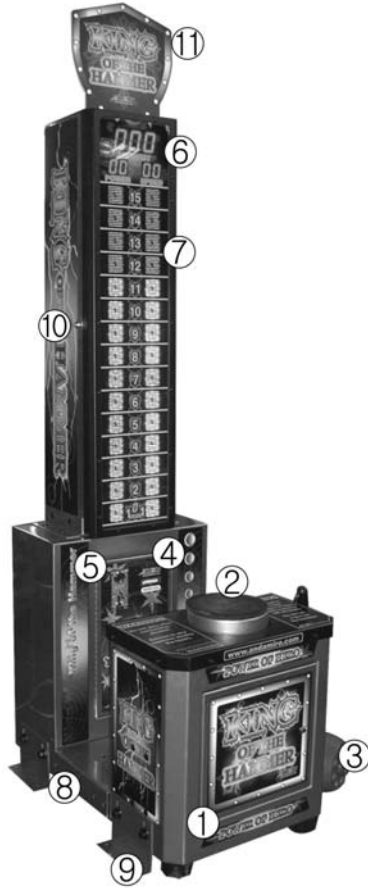

①	Front Door
②	Hitting Plate
③	Urethane Hammer
④	Ticket Dispenser
⑤	Coin Box
⑥	FND
⑦	High Intensity LED
⑧	Second Coupling Device
⑨	Frame for fixing
⑩	Upper KEY
⑪	Billboard A'SSY

Inner Part

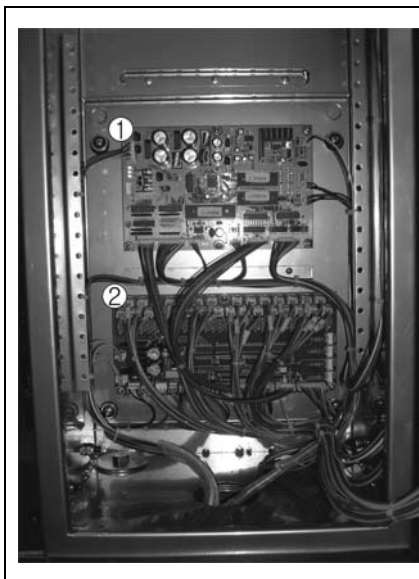

- ① Main PCB
- ② Solenoid & High Intensity LED Sharing PCB
- ③ FND PCB

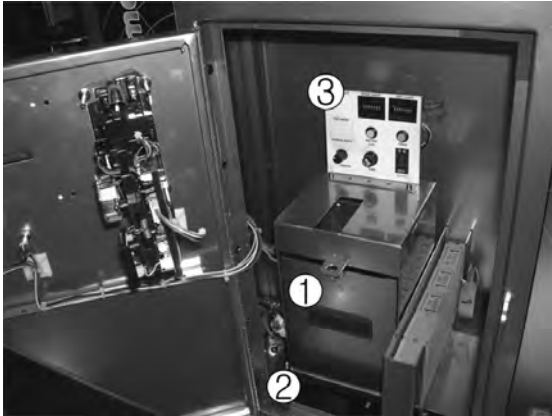

- ① Coin Box
- ② Trans
- ③ Counter and Sort of P/W & S/W

Inside of Hitting Plate

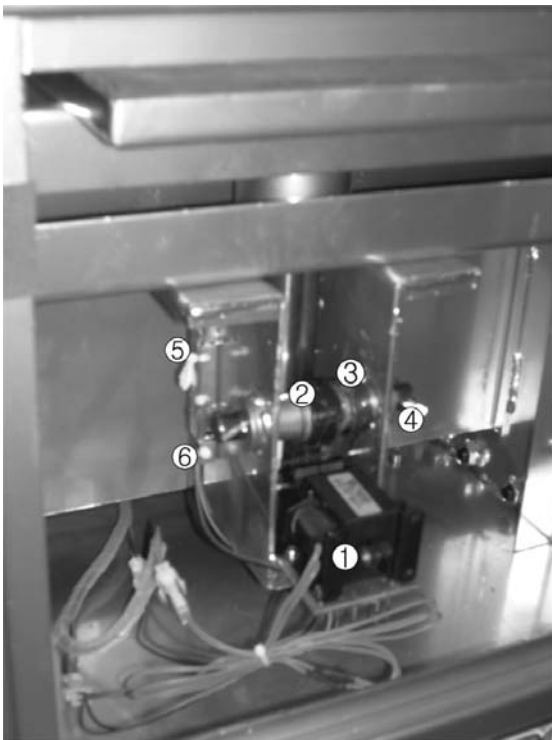

① Solenoid
② Processed part of \sqcap -shape (Another name: grasshopper)
③ 小 S.P
④ 15 \varnothing Pin
⑤ Position sensor
⑥ Speed sensor

4. Sort of PCB and Circuit Diagram

□ Main PCB

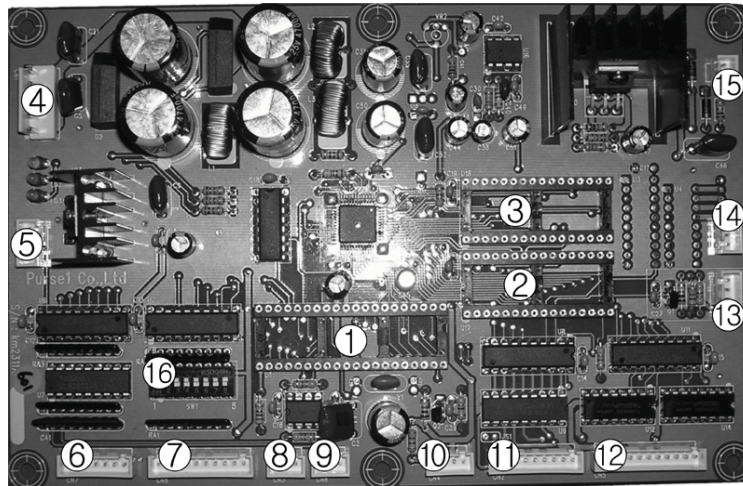

1. Main ROM	5. CN10 (Do not use)	9. CN6 (Do not use)	13. JP2 Positions sensor
2. Sound ROM	6. CN7 lo Board output.1	10. CN4 Speed sensor	14. JP1 Volume
3. Sound ROM	7. CN8 FND	11. CN2 lo Board output.2	15. CN9 Speaker
4. CNI1 POWER input	8. CN3 Coin Box	12. CN5 FND	16. Deep Switch

□ I/O PCB

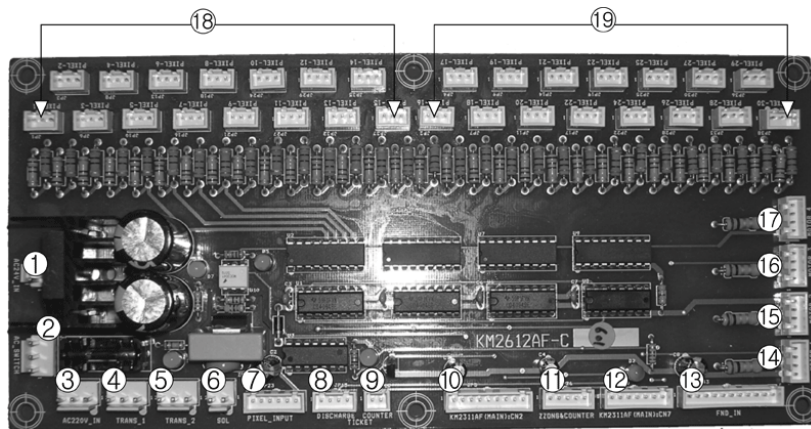

1. AC24V IN	6. SOL	11. 22ong Counter	18. High intensity LED Right signal(1~15)
2.AC SWITCH	7. FND output device	12. lo Board input 1	
3. AC 220V IN	8. Ticket dispenser	13. FND IN	19. High intensity LED Left signal(16~30)
4. TRANS 1	9. Ticket COUNTER	14~17. Do not use	
5. TRANS 2	10. lo Board input 2		

4-1. Circuit Diagram of Sort of PCB

□ Main circuit diagram

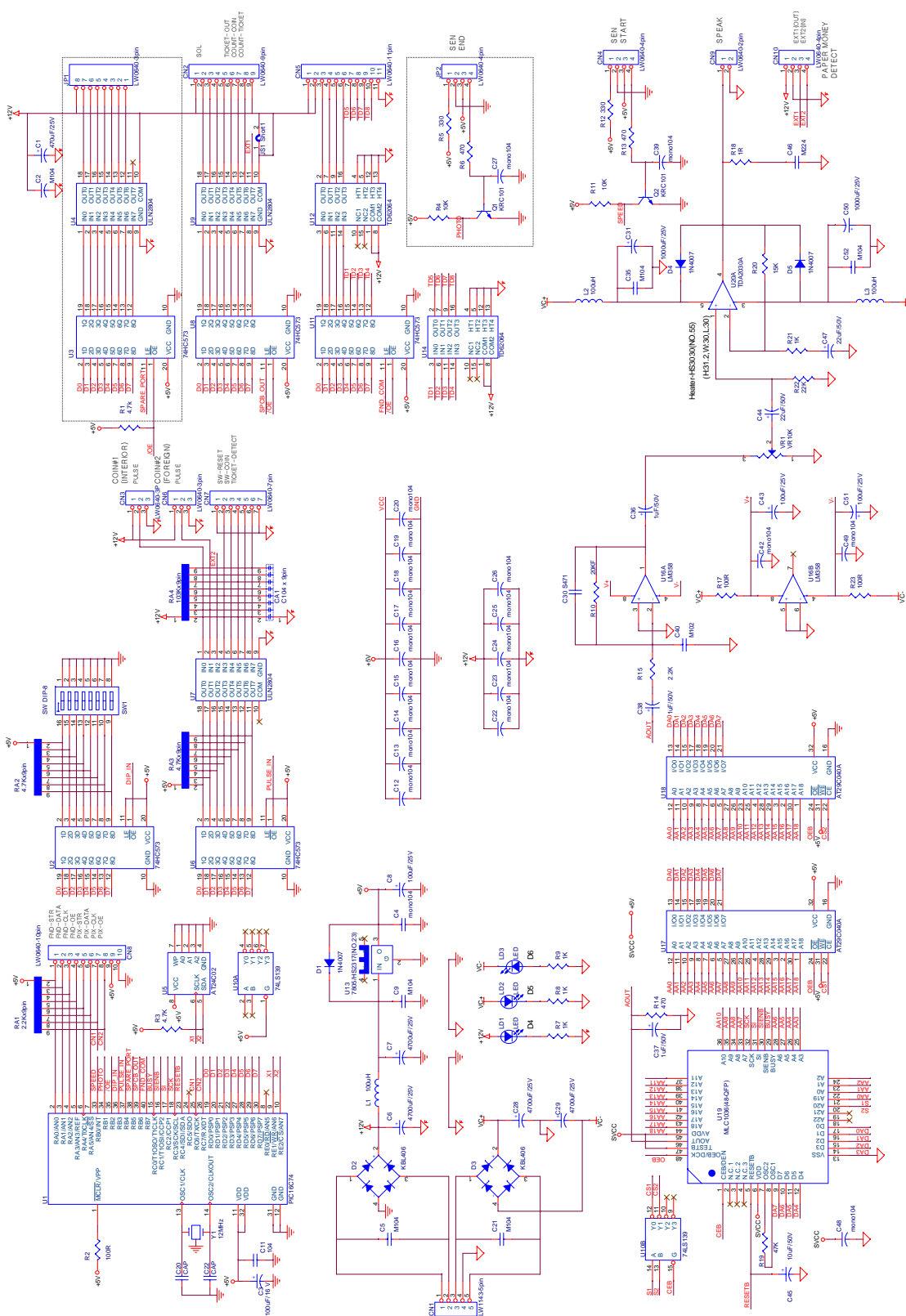

Rev. 1/2	Page 1/2
File Name: KWB07AE_PCB	Project: KWB07AE
Drawn: KWB07AE_PCB	Checked: KWB07AE_PCB
Date: 2025-03-20	By: BMI Gaming

□ FND (I/O) Circuit Diagram

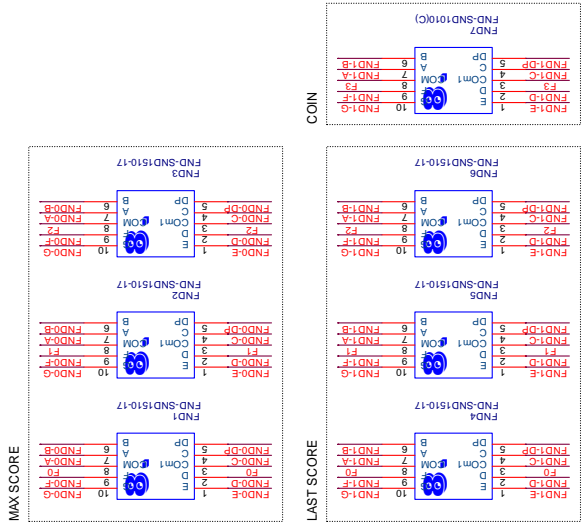

Title	Hammer Knight (FND) ver0.51		
Sheet	B	KM2308AF.PCB	Rev: 1
Date:	Thursday, August 23, 2018	Sheet	1 of 1

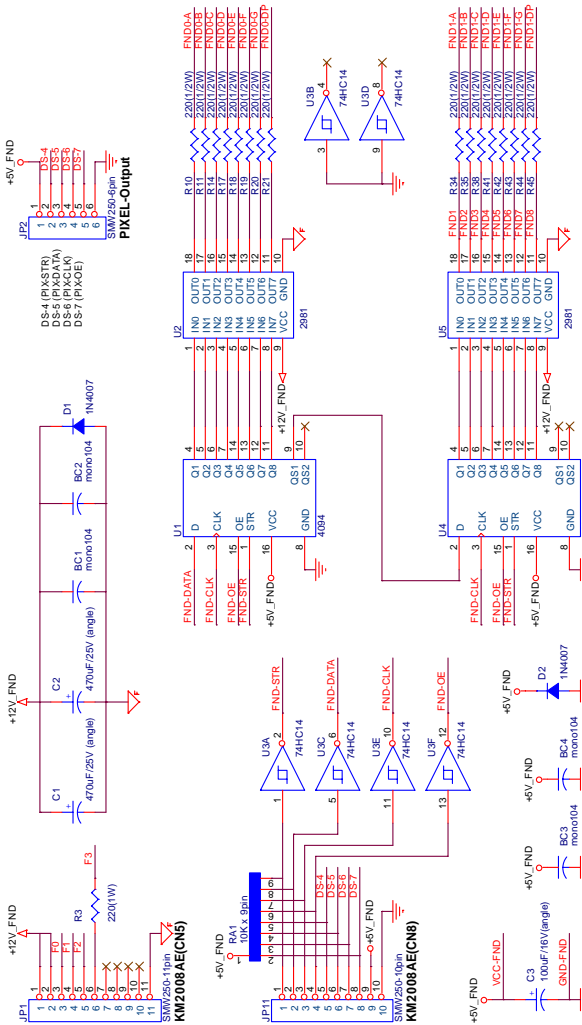

5. How to Control and Set the Mode

DIP S/W setting

KING OF THE HAMMER... ver 3.T (Power game)									
		1	2	3	4	5	6	7	8
1COIN/1 CREDIT		OFF							
2COIN/1 CREDIT		ON							
Free tickets	0		OFF	OFF					
	2		ON	OFF					
	4		OFF	ON					
	8		ON	ON					
Tickets per high score	0				OFF	OFF			
	10				ON	OFF			
	20				OFF	ON			
	30				ON	ON			
No function For ticket							OFF	OFF	
Ticket Over 820 score	5						ON	OFF	
Ticket Over 840 score	5						OFF	ON	
Ticket Over 860 score	5						ON	ON	
BACK UP									OFF
<p>* Back up function ON – always do not back up OFF – always auto back up</p> <p>*The high score is deducted by one point every play.</p>									

6. Part List

Name	Quantity	Material
PCB (per kind)	4EA(Main,FND, I/O PCB)	
Processed Steel (Milling product)	10 Kinds	
Aluminum Hitting Plate	1EA	Aluminum
Sticker and PC Print	일체	PC5T
Trans	1EA	110 or 220V
High Intensity LED	30EA	LED
Urethane Hammer	1EA	Urethane & MC
Solenoid	1EA	2K
Thrust Bearing	1EA	51110
Oilless Bearing	2EA	35X40X30
Pig tail	3EA	
S.P Large,Small	2EA	
Coin Box	1EA	
Ticket Dispenser	1EA	
Vibration-Proof Rubber	2EA	
Vibration-Proof Rubber 12M	10EA	

7. Trouble Shooting & Maintenance

In case of loosening a screw bolt

Tighten a screw bolt by using 10mm lens tool once a week



In case that the sensor is not checked

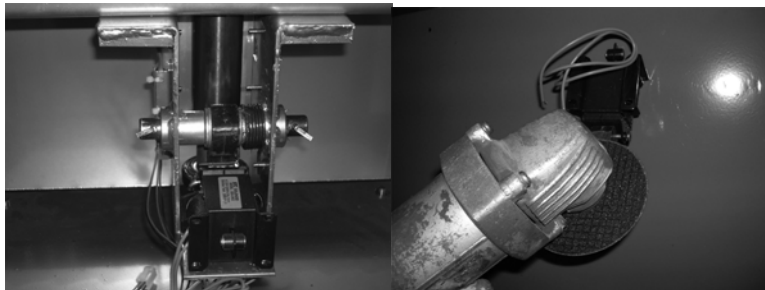

* Loosen Solenoid and S.P small-shaped part.

Grind processed part of \cap -shape with grinding tool such as a hand grinder.

When grinded too much, the Solenoid will not work well. Recommended grinding depth is approximately 1mm.

In case a hitting plate does not go up

* Solenoid works very well when a small amount of grease is applied on the processed part of \cap -shape.

In case of PCB problem

* Contact main office of manufacturer or the place of purchase.

8. How to Assemble

	
<p>① Full Body</p>	<p>② Binding steel plate</p>
	
<p>③ Hitting part</p>	

Meet positions of ① case and ③ hitting part and< Solenoid 2P, position sensor 3P, speed sensor 3P> interlink a connector.

Fix them by using 10EA of 12m screw bolt after covering ② binding steel plate.