

FIELD GOAL

USER MANUAL

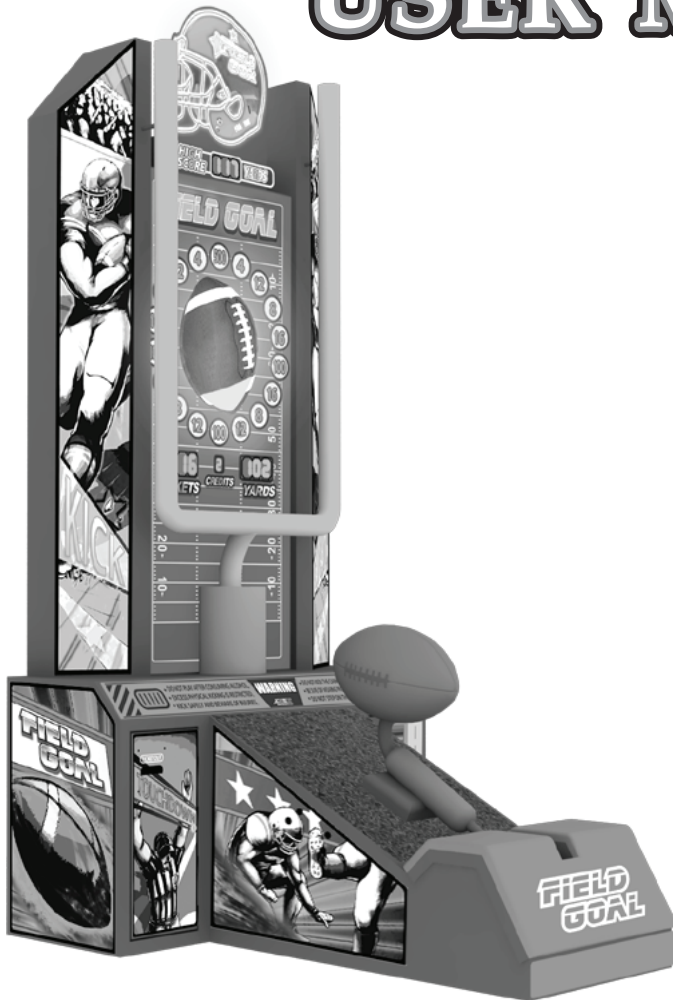

IMPORTANT

Please read the manual carefully and keep it in mind before using this machine.

Put this manual within touch of your reference in anytime.

1. PRECAUTIONS

1. Precautions before installation
2. Product Assembly Precaution
3. Moving & Handling Precautions
4. Management after Installation
5. Precautions during operating

2. PRODUCT SPECIFICATION

3. How to attach the wheel sticker according to each version

1. Check the stickers
2. Location of the stickers to attach
3. How to replace wheel sticker

4. TYPES OF PCBs & CIRCUIT DIAGRAM

1. MAIN PCB
2. POWER PCB
3. DISPENSER PCB
4. CABLE CONNECT
5. CIRCUIT DIAGRAM

5. GAME MODE SETTING

6. PARTS LIST

7. PRODUCT ASSEMBLY INSTRUCTION

8. ERRORS & TROUBLESHOOTINGS

1. PRECAUTIONS

1. Precautions before installation

Please make sure the power voltage & frequency requirements are compatible with the product installation location

A fire or electric shock can be caused if the proper voltage & frequency are not used

2. Product Assembly Precaution

Please get help from a specialist to assemble the product

Please follow the steps and instructions from the manual

Make sure to use the indoor cables that are compatible with the power consumption specification.

A fire or electric shock can be caused if the proper power consumption cables are not used

Make sure to use an independent power supply equipped with a surge-suppressor

A fire or electric shock can be caused if a power supply is used without a surge -suppressor

Please avoid putting the cables on the passageway

People may fall from trapping the cables

3. MOVING & HANDLING PRECAUTIONS

Make sure not to damage the power cables when moving the product

Damaged power cables can cause major product defects

Make sure not to twist or over pressed while on moving or transporting.

4. Management after Installation

Please note that using balls other than Genuine Andamiro football may cause damage to machine

5. Precautions during operating

Excessive actions may cause injury

Do not drink and play

Please kick the ball safely to avoid injury or any other accidents

Be sure not to kick the machine and the safety hitting cover

Be sure to wear a shoe when kicking the ball

Do not stand on the ball or machine

2. PRODUCT SPECIFICATION

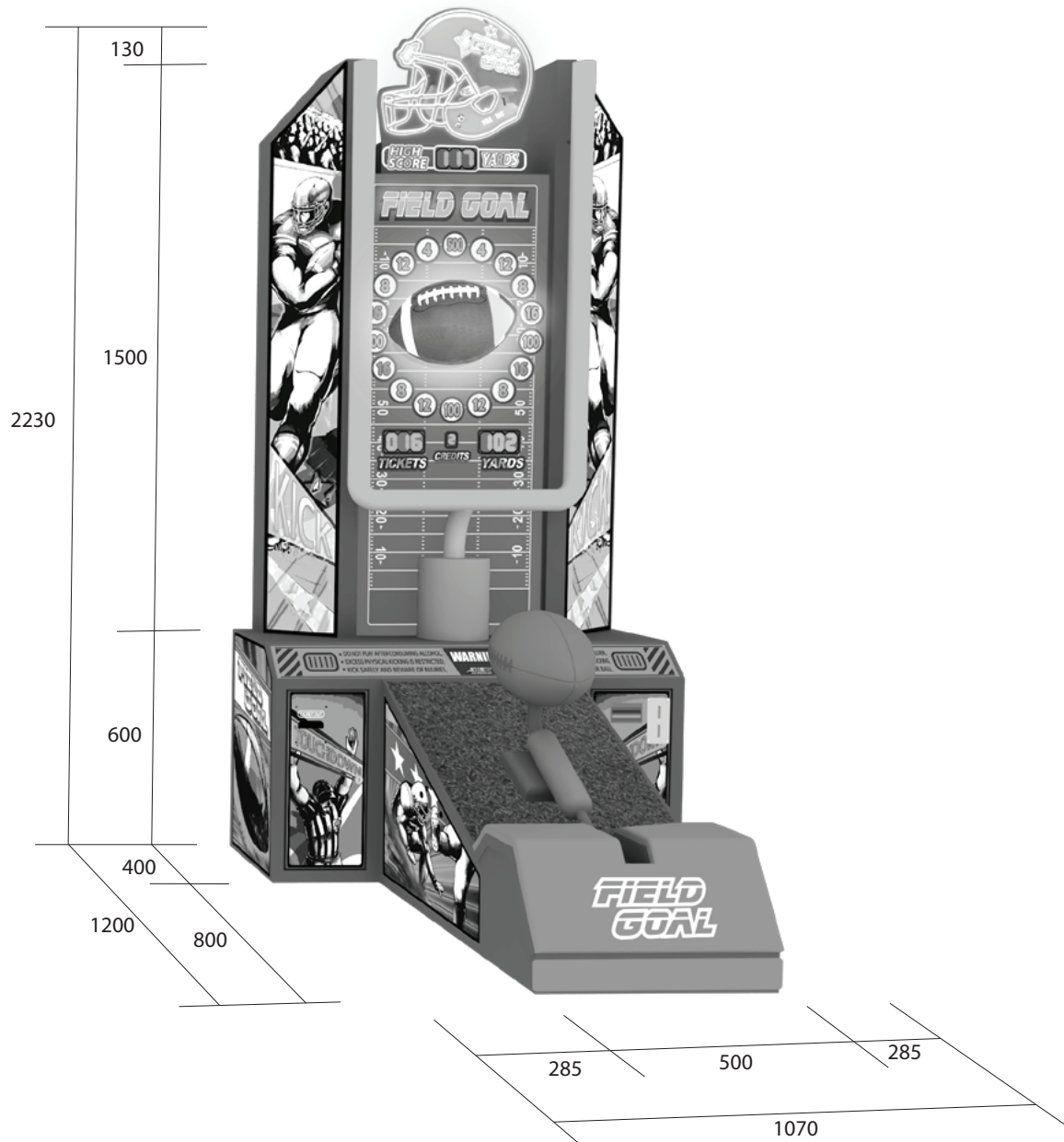

Power Requirement : 110V or 220V

Power Rating : 80W

Dimensions : W1070 X D1200 X H2230

(Height adjustment stopper installed 50~70 height up, Max height 2300)

Weight : 220Kg

3. How to attack the wheel sticker according to each version

3-1. List of stickers

Ticket number stickers for Version #1

	50cents(A)	75cents(B)	1USD(C)	CEC(D)
LED-1	250	400	500	20
LED-2	2	4	4	2
LED-3	6	10	12	3
LED-4	4	6	8	1
LED-5	8	12	16	4
LED-6	70	100	100	2
LED-7	8	12	16	4
LED-8	4	6	8	3
LED-9	6	10	12	1
LED-10	70	100	100	5
LED-11	6	10	12	2
LED-12	4	6	8	4
LED-13	8	12	16	1
LED-14	70	100	100	3
LED-15	8	12	16	4
LED-16	4	6	8	2
LED-17	6	10	12	3
LED-18	2	4	4	1

MEGA WIN Sticker

MEGA WIN 65 YARDS AND OVER 100 Tickets	MEGA WIN 65 YARDS AND OVER 100 Tickets	MEGA WIN 65 YARDS AND OVER 100 Tickets	MEGA WIN 65 YARDS AND OVER 100 Tickets
0-20 Yards 1 Tickets	41-50 Yards 30 Tickets	2 1	100 100
21-30 Yards 10 Tickets	51-60 Yards 40 Tickets	3 10	200 200
31-40 Yards 20 Tickets	61-64 Yards 50 Tickets	4 20	250 250
		5 30	300 300
		10 40	400 400
		1 50	500 500
		2	700 700
		4	900 900
		6	

FREE TICKETS Sticker

Free Tickets → 2	Tickets per Highscore → 6
Free Tickets → 4	Tickets per Highscore → 10
Free Tickets → 6	Tickets per Highscore → 20

Strength version sticker to cover ticket FND (no tickets)



Strength version Wheel sticker

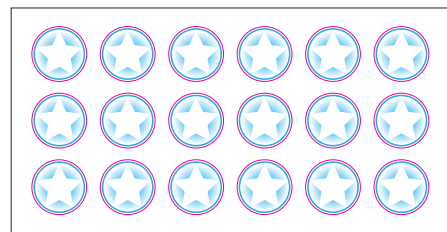

Tickets, coin, Bill sticker

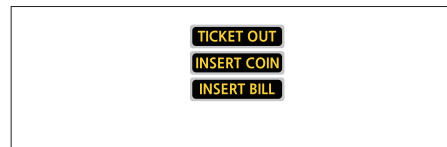

Bolt cover sticker of wheel

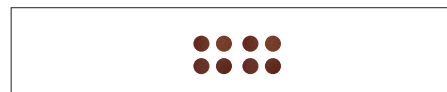

3-2. Location of the stickers to attach

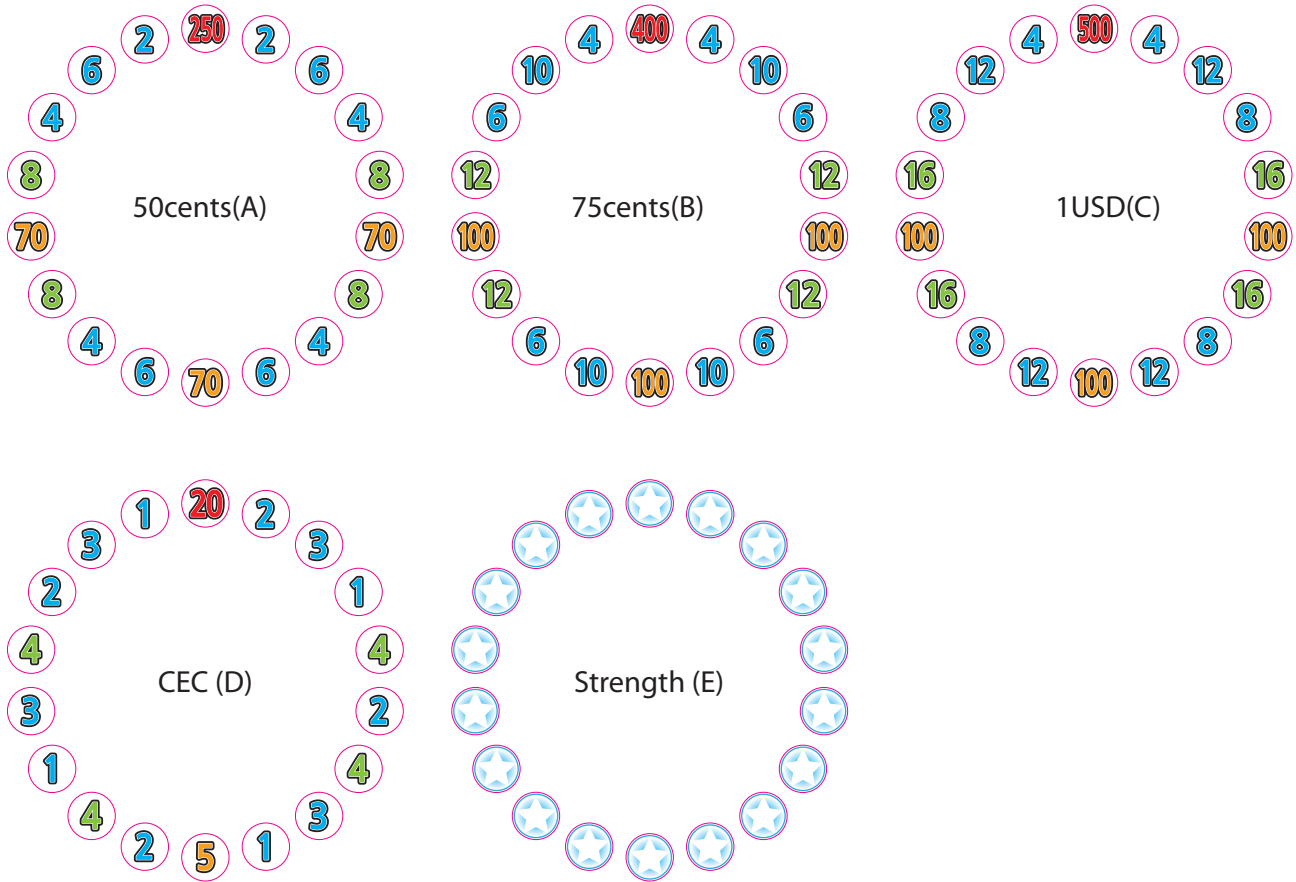

3-3. How to replace wheel sticker

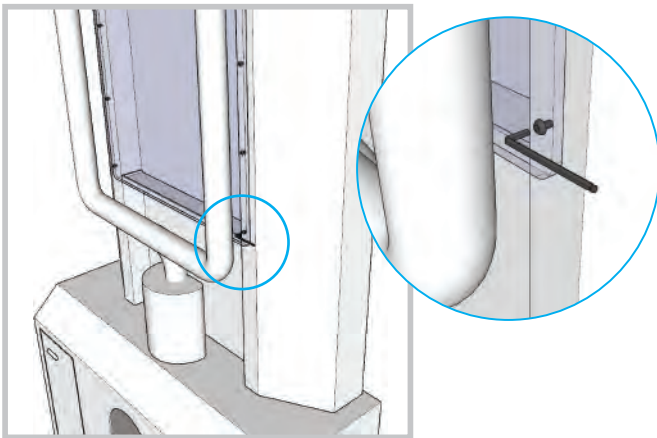

- 1) Using the 4mm wrench driver, the bolt of acrylic cover.
- 2) Attach the sticker after checking the location of the stickers.
(Attention: No extra sticker !!)
- 3) Assemble the acrylic cover again.

4. TYPES OF PCBs & CIRCUIT DIAGRAM

4-1. MAIN PCB

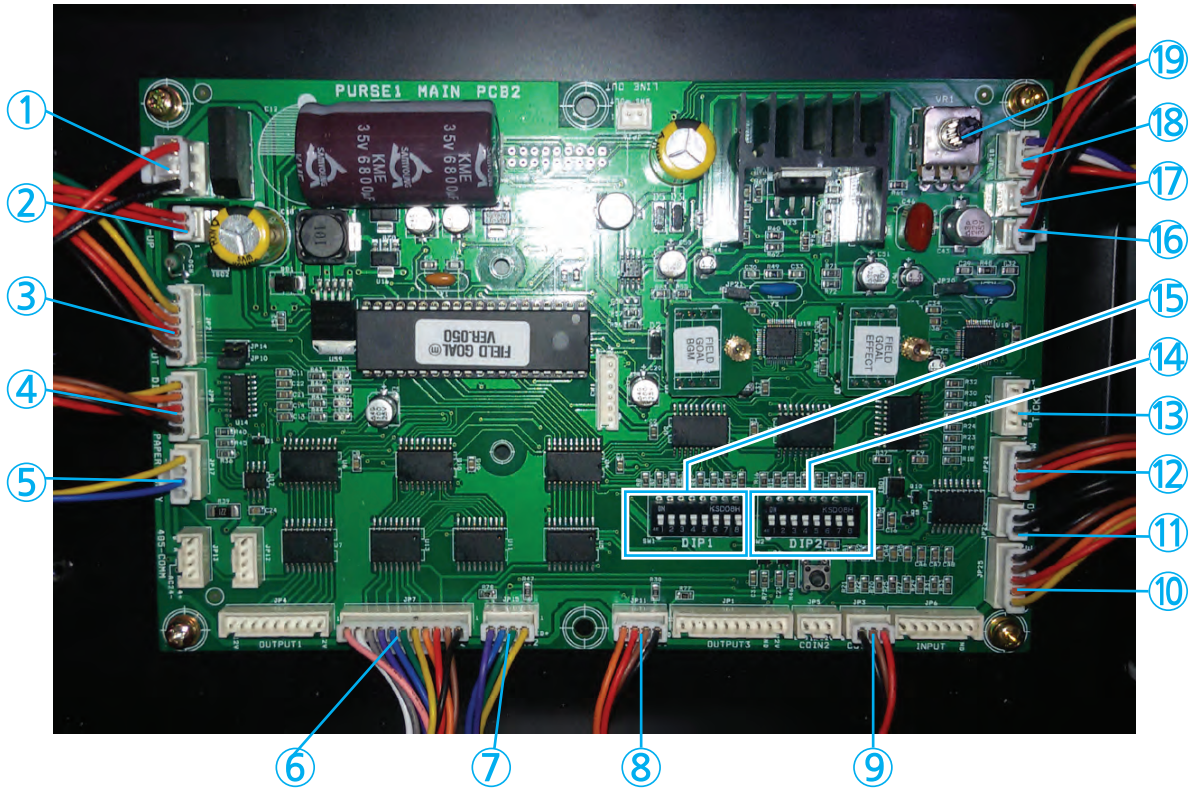

- | | |
|---|-------------------------------|
| 1. AC24V input (from Drive JP7) | 11. Tickets counter output |
| 2. Backup input (Extra power, AC 110 or 220V) | 12. Tickets switch output |
| 3. Driver PCB JP9 output | 13. Tickets output |
| 4. Driver PCB JP3 output | 14. DIP 2 |
| 5. Bill output | 15. DIP 1 |
| 6. Driver PCB JP14 output | 16. Speaker 1 output |
| 7. Porter sensor output(location) | 17. Speaker 2 output |
| 8. Porter sensor output(speed) | 18. Volume output (setup box) |
| 9. Driver PCB JP22 output | 19. Volume |
| 10. Service, Reset, Coin counter output | |

4-2. DRIVER PCB

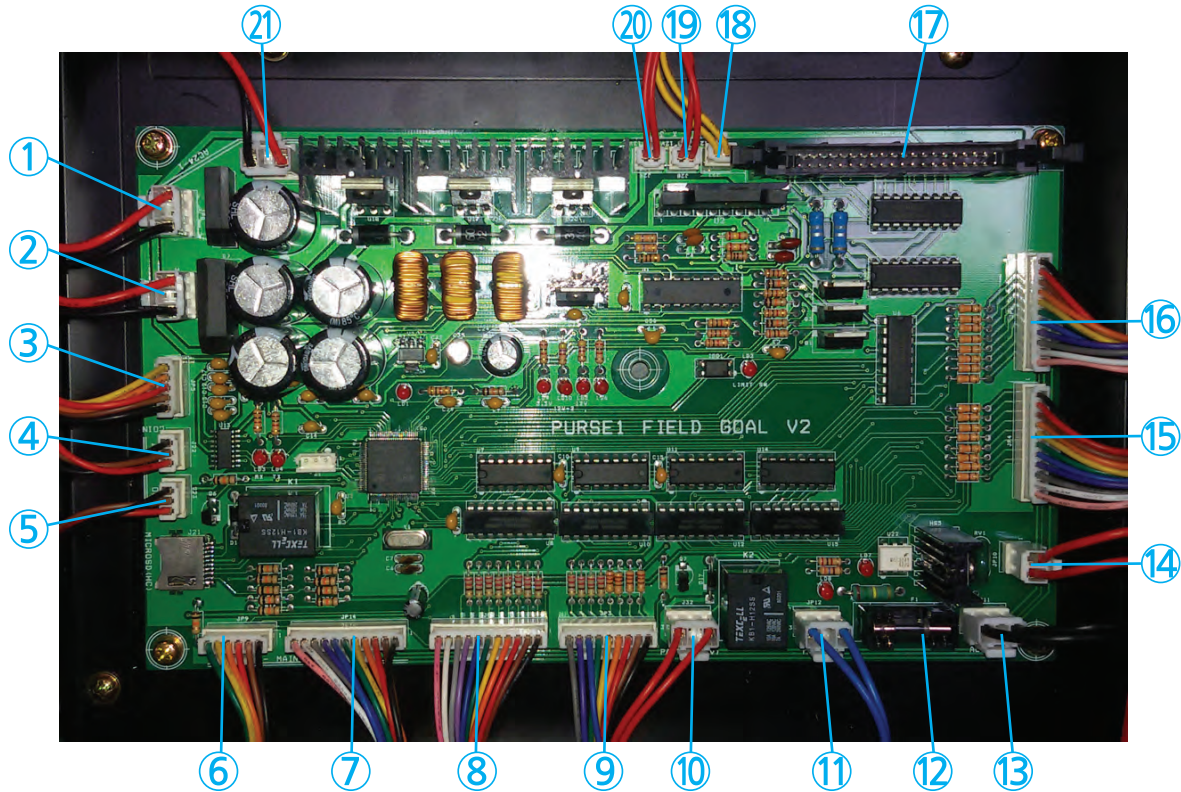

- | | | |
|-------------------------------|---|---------------------------------|
| 1. AC24V input(from trance) | 11. Trance output (AC 110 or 220V) | 21. Main PCB JP8 Output (AC24V) |
| 2. AC24V input(from trance) | 12. Fuse (AC 110 or 220V, 3A) | |
| 3. Main display Port input | 13. AC 110 or 220V inputs (from noise filter) | |
| 4. Main PCB JP3 input | 14. Solenoid output (AC 110 or 220V) | |
| 5. Coin output | 15. Tickets FND output | |
| 6. Main serial output port | 16. High score FND output | |
| 7. Main JP7 input | 17. Dispenser PCB JP 33 output | |
| 8. Yards FND output | 18. Field goal LOGO LED output | |
| 9. Credits FND output | 19. Kick, red LED output | |
| 10. Bill AC110 or 220V output | 20. Kick, red LED output | |

4-3. DISPENSER PCB

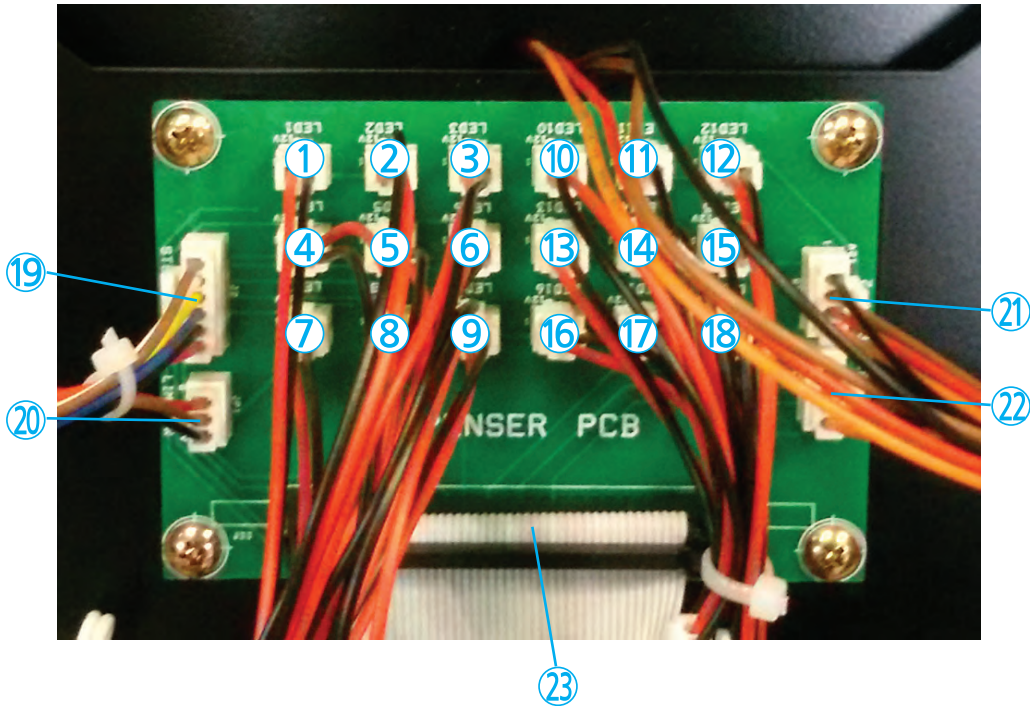

- 1. LED-1 output(Wheel)
- 2. LED-2 output(Wheel)
- 3. LED-3 output(Wheel)
- 4. LED-4 output(Wheel)
- 5. LED-5 output(Wheel)
- 6. LED-6 output(Wheel)
- 7. LED-7 output(Wheel)
- 8. LED-8 output(Wheel)
- 9. LED-9 output(Wheel)
- 10. LED-10 output(Wheel)

- 11. LED-11 output(Wheel)
- 12. LED-12 output(Wheel)
- 13. LED-13 output(Wheel)
- 14. LED-14 output(Wheel)
- 15. LED-15 output(Wheel)
- 16. LED-16 output(Wheel)
- 17. LED-17 output(Wheel)
- 18. LED-18 output(Wheel)
- 19. Steping Motor output
- 20. Limit switch output

- 21. Wheel RGB LED output
- 22. Tower RGB LED output
- 23. Driver JP34 input

4-4. CABLE CONNECT

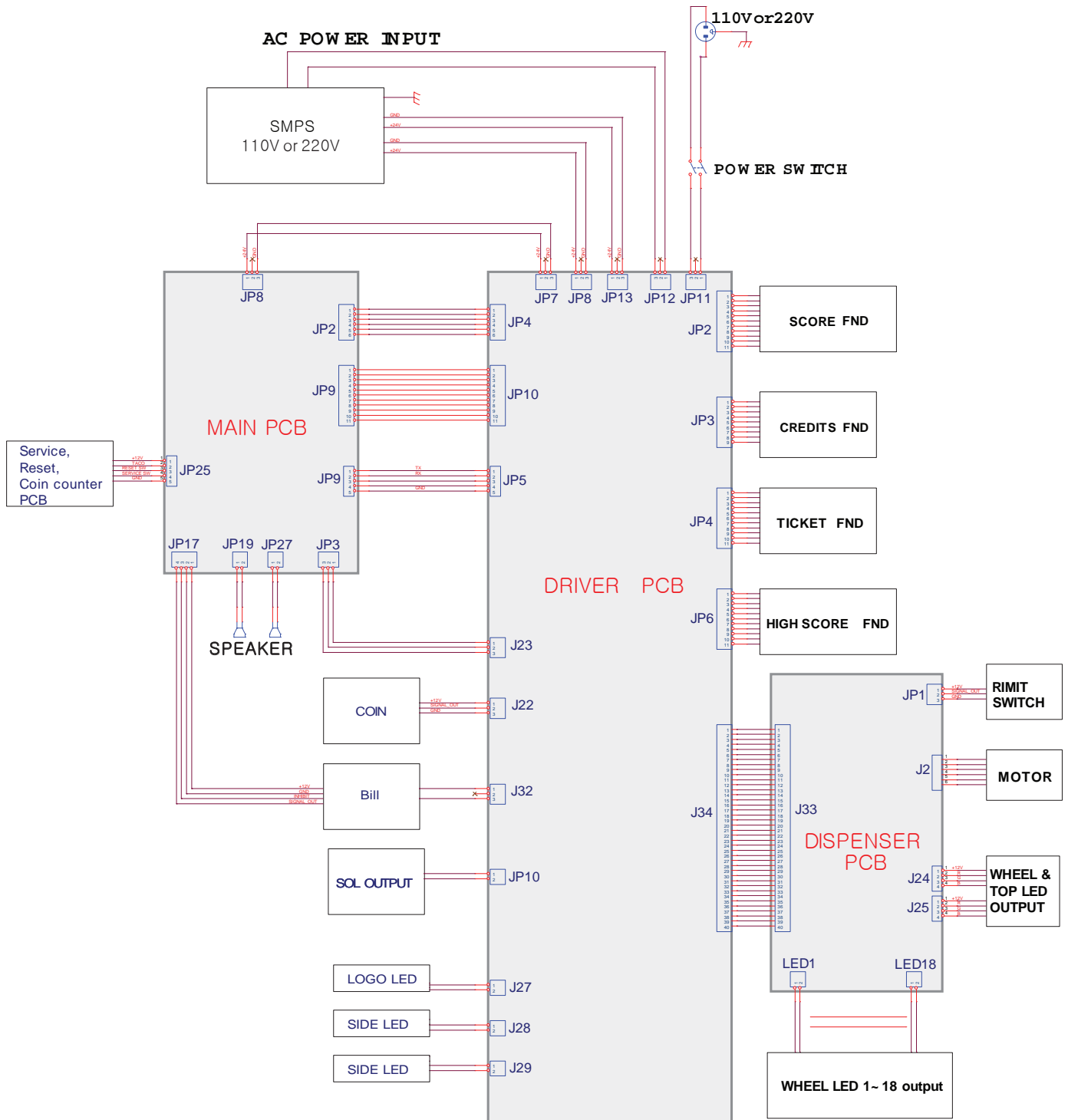

4-5. CIRCUIT DIAGRAM (MAIN PCB)

MAIN PCB

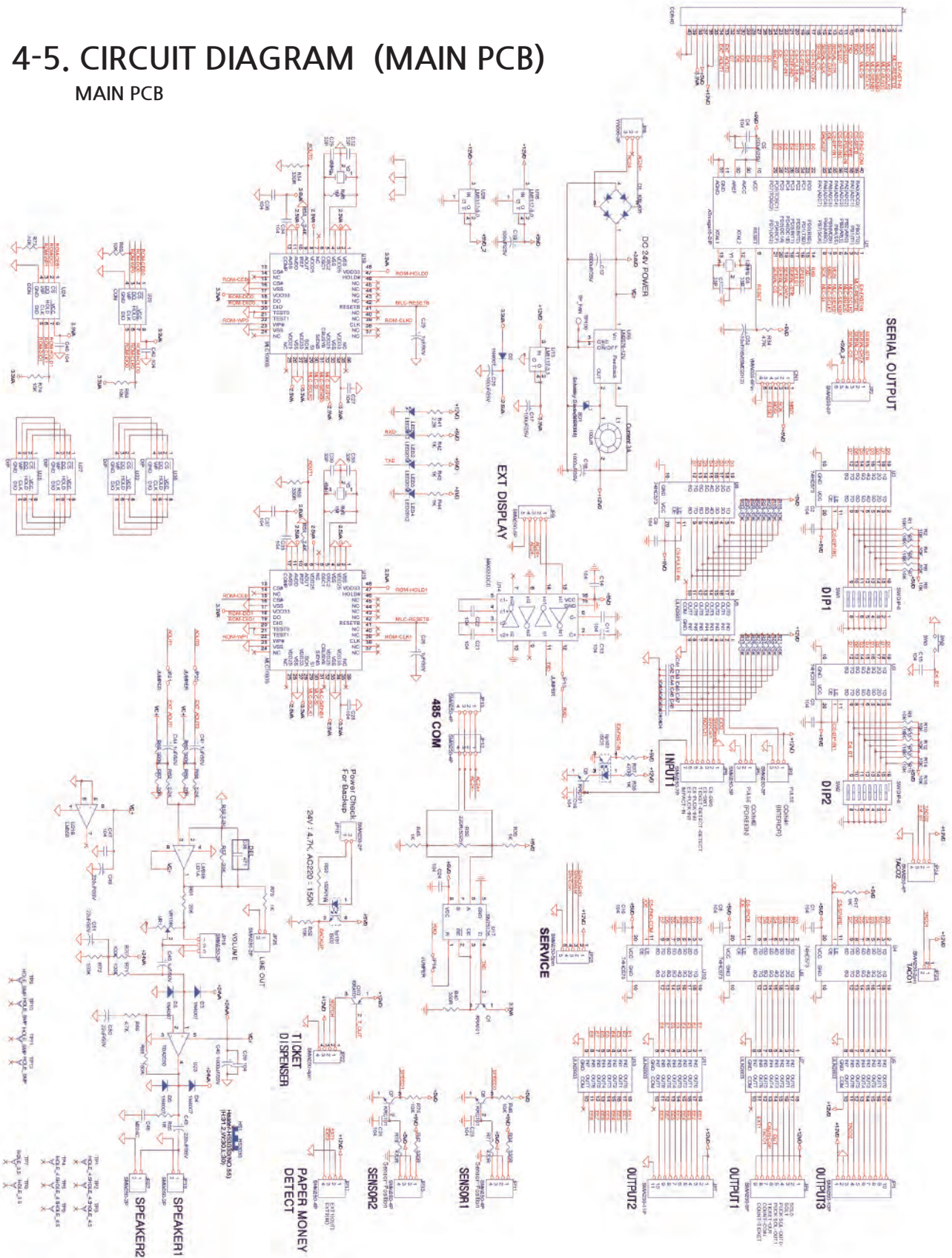

4-5. CIRCUIT DIAGRAM (DRIVER PCB, DISPENSER PCB)

DRIVER PCB

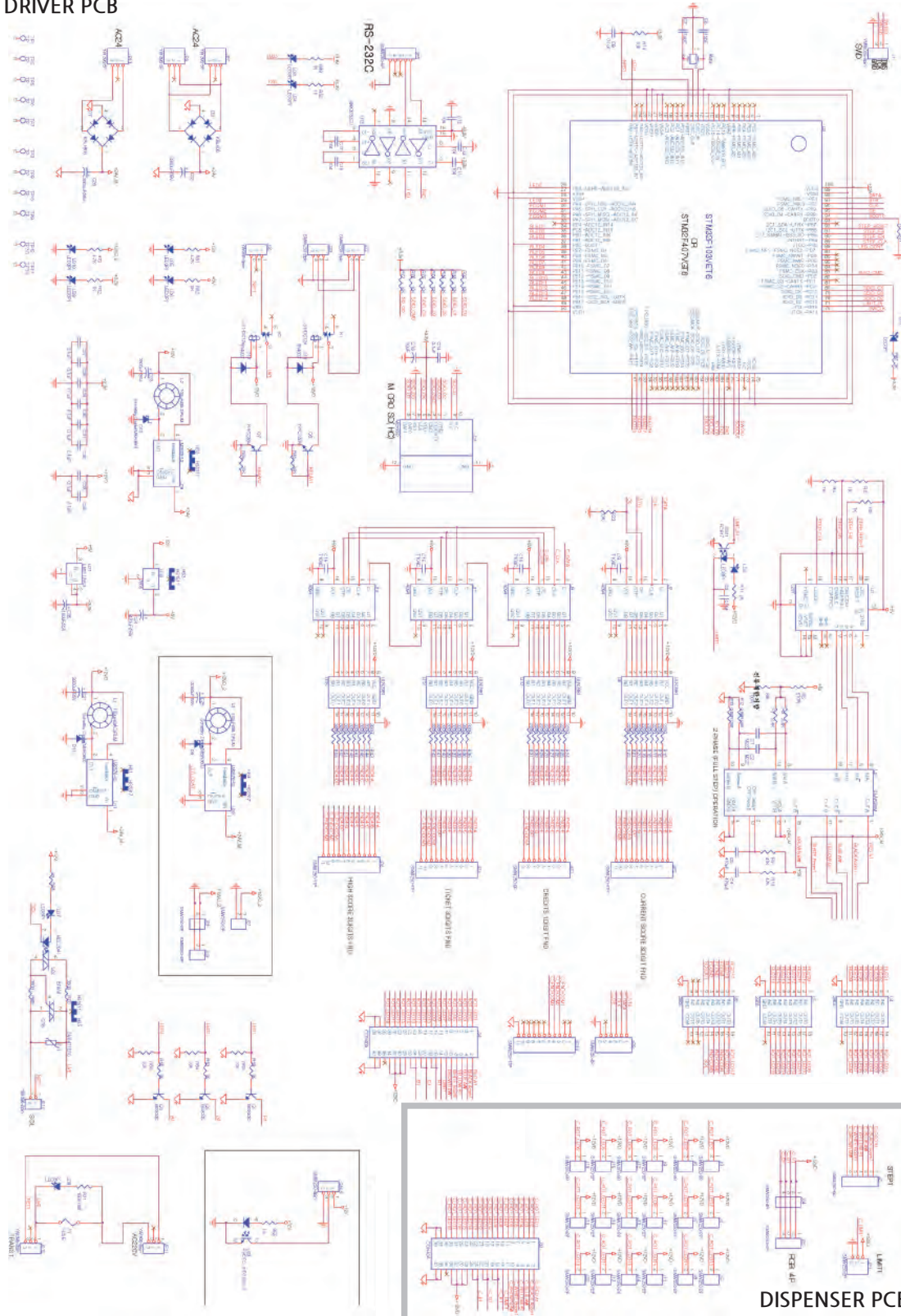

DISPENSER PCB

5. GAME MODE SETTING

Version#1

* POWER VERSION (Ver. 3.0)

- No ticket Base,

- SETTING

Dip switch Setting,

- On/ Kids x2 power (x2 points)

: Display doubled up points on FND (NEW VERSION)

- Off/TEEN/ADULT – no change (current point system)

Please download the current version using by attached SD card.

Downloading current version

- Turn off the machine.

- insert the SD card.

- Turn on the machine and wait for around 5 seconds

- Turn Off and take out the Card.

DIP SWITCH 1		1	2	3	4	5	6	7	8
1COIN/1play		OFF	OFF						
2COIN/1play		ON	OFF						
3COIN/1play		OFF	ON						
4COIN/1play		ON	ON						
Ticket per high score	0			OFF	OFF				
	6			ON	OFF				
	10			OFF	ON				
	20			ON	ON				
Back up per power ON/OFF						ON			
DEMO SOUND&PLAY							ON		
mercy ticket	0							OFF	OFF
	2							ON	OFF
	4							OFF	ON
	6							ON	ON

* High score is deducted by 1 every play

DIP SWITCH 2		1	2	3	4	5	6	7	8
ticket layout	A	OFF	OFF						
	B	ON	OFF						
	C	OFF	ON						
	NO	ON	ON	<= Move to Version#2					
average 10 tickets for A type				OFF	OFF	OFF	OFF		
average 15 tickets for A type				ON	OFF	OFF	OFF		
average 20 tickets for A type				OFF	ON	OFF	OFF		
average 25 tickets for B type				ON	ON	OFF	OFF		
average 30 tickets for B type				OFF	OFF	ON	OFF		
average 35 tickets for B type				ON	OFF	ON	OFF		
average 30 tickets for C type				OFF	ON	ON	OFF		
average 40 tickets for C type				ON	ON	ON	OFF		
average 45 tickets for C type				OFF	OFF	OFF	ON		
average 50 tickets for C type				ON	OFF	OFF	ON		
average 3.6 tickets for CEC type				ON	ON	OFF	ON		
HALF TICKET								ON	
FREE PLAY		When the machine is powered on, keep the service button pushed for FREE PLAY for 5seconds.							

LED,FND TEST When the machine is powered on, keep the RESET button pushed for TEST MODE of LED number, To move to the next LED, Push the service button

Version#2

DIP SWITCH 1		1	2	3	4	5	6	7	8
1COIN/1play		OFF	OFF						
2COIN/1play		ON	OFF						
3COIN/1play		OFF	ON						
4COIN/1play		ON	ON						
Ticket per high score	0			OFF	OFF				
	6			ON	OFF				
	10			OFF	ON				
	20			ON	ON				
HALF TICKET						ON			
DEMO SOUND&PLAY							ON		
Tickets for 0~20 yards	1							OFF	OFF
	2							ON	OFF
	4							OFF	ON
	6							ON	ON

* High score is deducted by 1 every play

DIP SWITCH 2		1	2	3	4	5	6	7	8
Version#2 funtion ON		ON	ON						
Ticket-out On/OFF				ON					
A TYPE					OFF				
B TYPE					ON				
100 ticket for MEGA WIN						OFF	OFF	OFF	
200 ticket for MEGA WIN						ON	OFF	OFF	
250 ticket for MEGA WIN						OFF	ON	OFF	
300 ticket for MEGA WIN						ON	ON	OFF	
400 ticket for MEGA WIN						OFF	OFF	ON	
500 ticket for MEGA WIN						ON	OFF	ON	
700 ticket for MEGA WIN						OFF	ON	ON	
900 ticket for MEGA WIN						ON	ON	ON	
FREE PLAY		When the machine is powered on, keep the service button pushed for FREE PLAY for 5seconds.							

MEGA WIN over 65 yards

LED,FND TEST When the machine is powered on, keep the RESET button pushed for TEST MODE of LED number, To move to the next LED, Push the service button

FIELD GOAL

MODE SETTING

Ticket setting for VERSION #2

A TYPE

yards	tickets
0-20	#7, 8 of DIP SW1
21-30	2
31-40	3
41-50	4
51-60	5
61-64	10

B TYPE

yards	tickets
0-20	#7, 8 of DIP SW1
21-30	10
31-40	20
41-50	30
51-60	40
61-64	50

Location of the MEGA WIN stickers



MEGA WIN		MEGA WIN		YARD STICKER		MEGA WIN STICKER	
MEASN OVER 65 Yards		MEASN OVER 65 Yards		2	1	100	100
100 Tickets		100 tickets		3	10	200	200
0~20 Yards	10 Tickets	41~50 Yards	40 Tickets	4	20	250	250
21~30 Yards	20 Tickets	51~60 Yards	50 Tickets	5	30	300	300
31~40 Yards	30 Tickets	61~64 Yards	60 Tickets	10	40	400	400
				1	50	500	500
				2		700	700
				4		900	900
				6			

6. PART LIST

PART NAME		Q'TY	PART NAME	Q'TY
PCB	MAIN PCB	1	SOLENOID	1
	DRIVER PCB	1	SAFETY COVER	1
	DISPENSER PCB	1	SPEAKER	2
	FND PCB	4	TICKET MACHINE	1
CABLES		1	COIN MECHINE	1
SHAFTS		1	ARTIFICAL GLASS	1
BLADE BUSHING		1	URETHAN PROTECT PAD 4	1
BEARING		2	LOCATION SENSOR	2
TOWER LIGHT		1	SPPED INDICATION SENSOR	1
WHEEL		1	GOAL BAR	1
BILLBOARD		1	CABINET	1
ACRYL COVER		1		
LEFT, RIGHT ACRYL		2		
FRONT ACRYL		1		
STICKER		1		
FOOTBALL BALL		1		
FOOTBALL POLL		1		
STEPPING MOTOR		1		
TRANS		1		
PROTECT PAD		1		

7. PRODUCT ASSEMBLY INSTRUCTION

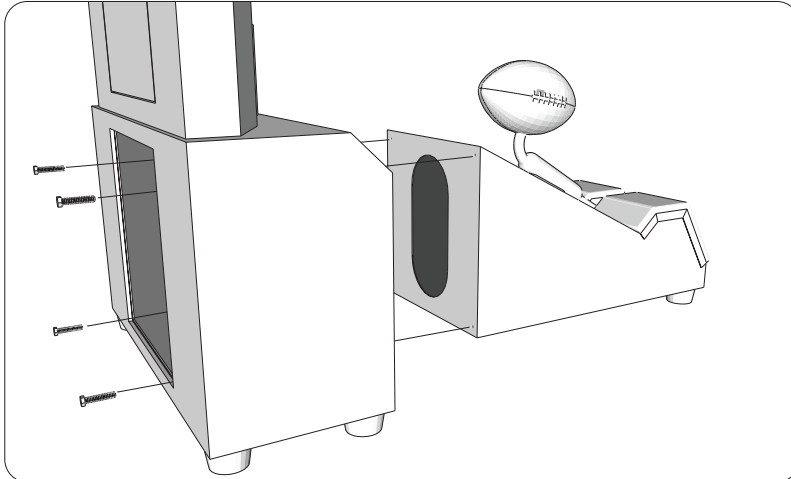

Step 1.

- 1) Open the rear door of main lower console.
- 2) Connect main lower console and kicking console by using enclosed bolt, washer and spring washer and then connect cables.

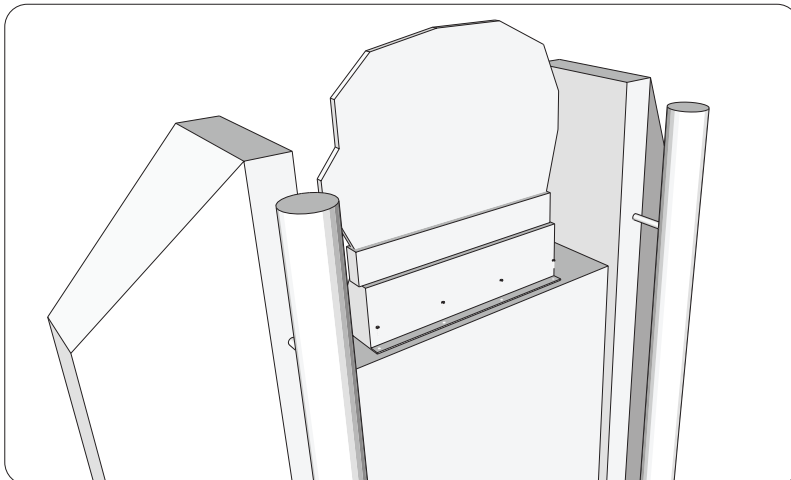

Step 2.

- 1) Open the rear door of main upper console
- 2) Install the tower light by using enclosed bolt and nylon nuts.
- 3) connect cables

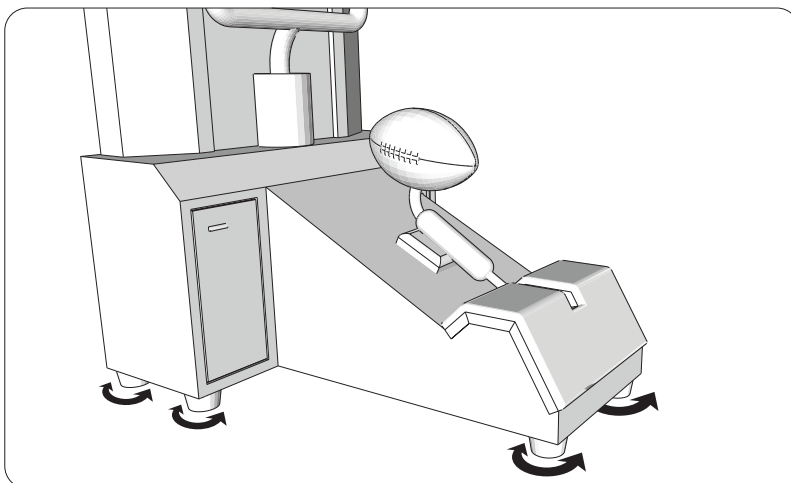

Step 3.

- 1) Adhere machine closely to the ground by circling the rubber stopper installed on the bottom of machine.

- SUBSIDIARY MATERIAL FOR ASSEMBLY

12mm Bolt ,Washer, Spring Washer



4mm wrench driver



4mm Bolt, Cable Ties, NY Nut, Mount base



AC Power Cable (110V or 220V)

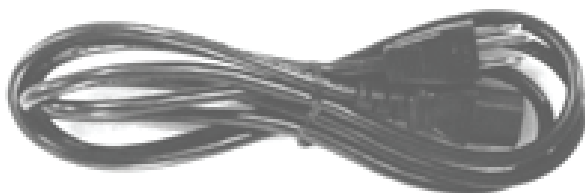

110V



220V

8. Errors and Trouble shootings

SYMPTOM	CHECK(CAUSE)	CORRECTION
No power on	<ul style="list-style-type: none"> - Check power cable - Check power switch - Check fuse status 	<ul style="list-style-type: none"> - Check cables, switch, fuse and change
No FND window	<ul style="list-style-type: none"> - Check connecting cable between PCB and FND 	
No sound	<ul style="list-style-type: none"> - Check connecting cable between PCB and speaker - Damaged speaker 	<ul style="list-style-type: none"> - Check cables and speaker and change
No more game processing such as no point display or no wheel movement in spite of kicking a ball	<ul style="list-style-type: none"> - Check speed indicating sensor or Sensor blade - Check sensor connecting cable 	<ul style="list-style-type: none"> - Check cables, blade, sensor and change (Refer to 20p)
FND Error 1 the ball does not come to kicking position	<ul style="list-style-type: none"> - FND Error No 1 displays in case that the ball does not come to kicking position. - In case of pushing the ball by force - In case of weakened spring tension 	<ul style="list-style-type: none"> - Check foreign material - Adjust spring tension (refer to 20 p) - Turn off the power and restart the machine
FND Error 2 the ball does not spin normally	<ul style="list-style-type: none"> - FND Error no 2 displays in case that the ball does not spin normally - Check location sensor inside of the wheel - Check stepping motor 	<ul style="list-style-type: none"> - Open the cover and disassemble the wheel. and check sensor and motor - Turn off the power and restart the machine

- How to change the ball



After removing bolt from the ball connector, replace old ball with a new ball

- How to change the ball poll

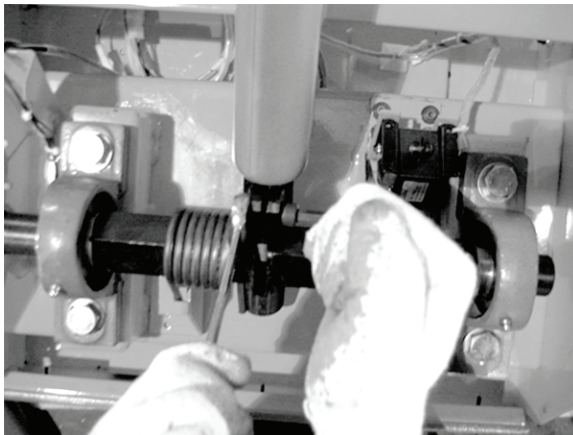

Remove the bolt from the ball connecting assembly by using a spanner and an wrench

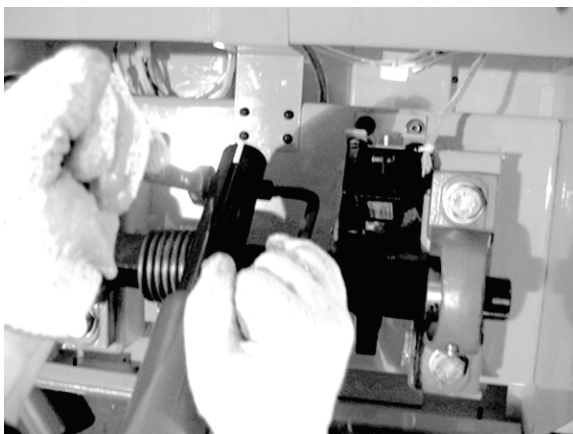

By using a spanner and an wrench, remove the bolt crossing between ball connecting assembly and ball poll and then assemble the new ball poll

- Checking or changing of location sensor and speed indication sensor

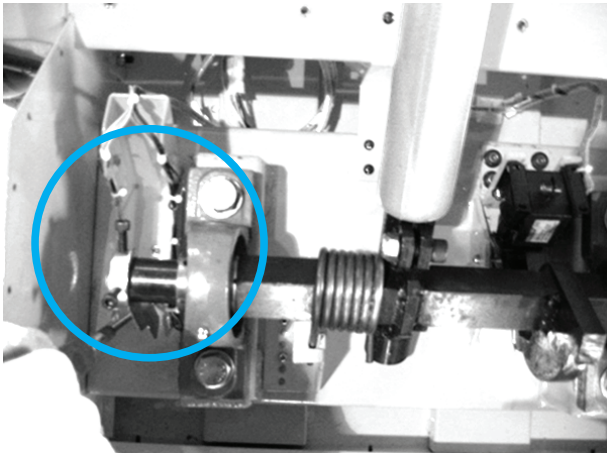

When the machine does not recognize the score, replace a sensor bracket,

Change the connector by removing 2 bolts shown in the picture above

Tip> Correct location of blade: It operates normally when it indicates the rear location sensor while a ball comes forward

- Spring tension control

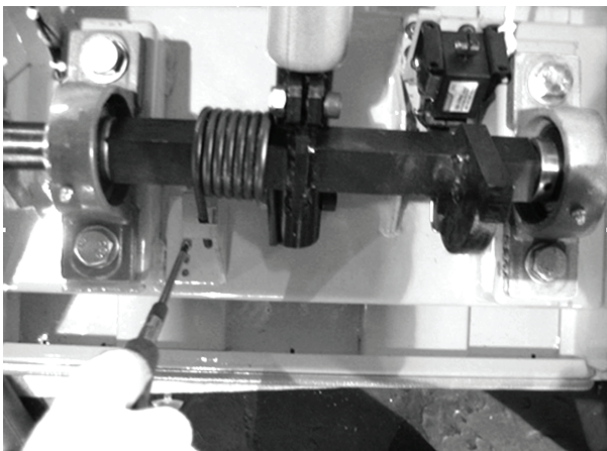

When a ball come to kicking position without power, adjust the spring tension after dissembling tension control device, move the tension control one level forward to make the tension loose
move the tension control one level backward to make the tension tight

FIELD GOAL



ANDAMIRO CO.LTD (ANDAMIRO KOREA)
611-19, Changhang-dong, Ilsan-gu, koyang-si,
Kyong gi-do, 411-380 Korea
TEL. 82-31-909-2121 / FAX : 82-31-908-7548
<http://www.andamiro.com>
e-mail: sales@andamiro.com

ANDAMIRO USA CORP(ANDAMIRO USA)
19140 S. VAN NESS AVE. TORRANCE, CA 90501 USA
TEL : 310-782-3377 / FAX : 310-782-3360
Toll Free No : 1-866-ANDAMIRO
<http://www.andamirousa.com>
e-mail : sales@andamirousa.com