

# Silver Strike LIVE™ Showpiece™ Cabinet Video and Audio Connections Guide

---



©2010 Incredible Technologies, Inc. All Rights Reserved



For More Information, Visit BMI Gaming | [www.bmigaming.com](http://www.bmigaming.com) | 1-800-746-2255 | 1-561-391-7200



## Contents

<a href="#">Diagram Reference (DIP Switches, Television Inputs)</a>	3
<a href="#">Helpful Tips Before Starting</a>	4
<b>Silver Strike LIVE</b>	
▪ <a href="#">Component (7300 VC)</a>	5
▪ <a href="#">VGA (5200/7300 VC)</a>	6
▪ <a href="#">DVI to HDMI (5200/7300 VC)</a>	7
▪ <a href="#">Secondary Monitor</a>	8
<a href="#">Connection / Resolution Options for SS LIVE</a>	9

## Diagram Reference

### DIP Switches

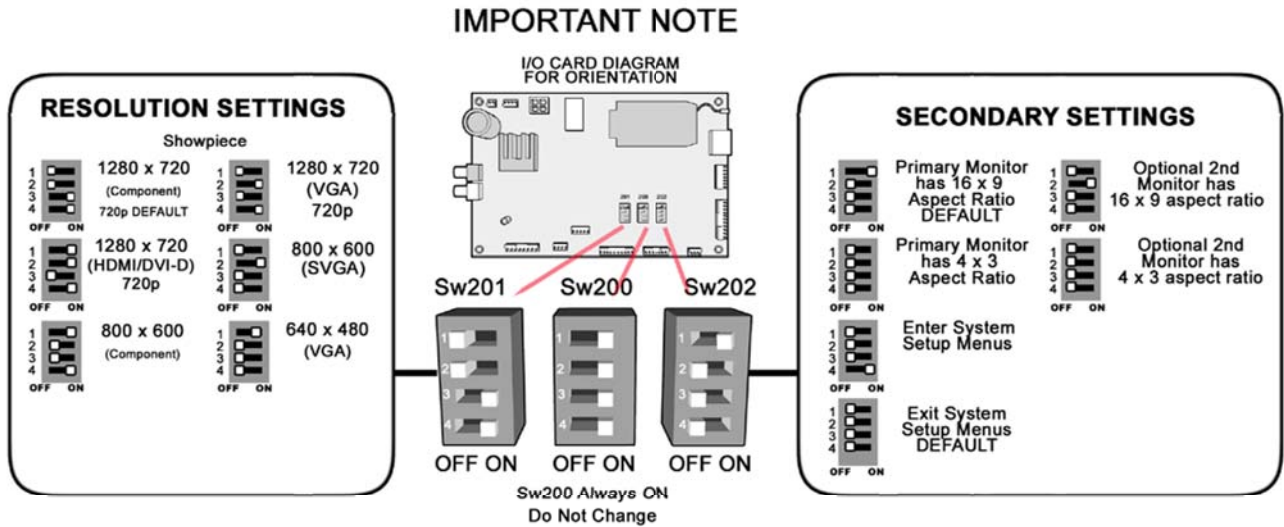

### Television Inputs



**Rear Television Inputs - Example**



### Helpful Tips Before Starting

- When choosing a television, verify that it is capable of displaying the minimum resolution type for a Showpiece cabinet: 720p.
- Make sure to power ON the television and select the correct video input before powering up the game.
- Make sure that the DIP switch SW-202 (Switch 1) is in the ON position to enable 16:9 aspect ratio when running 1280x720 resolution.
- When routing audio through the television, the Game Volume Setting needs to be adjusted up to 75%. Then use the television volume control as the Master Volume.
- In the event the image being displayed is overshooting *or* not extending to the perimeter of the screen, increase or decrease the image size by going to **Main Menu → Troubleshooting Shortcuts → Screen Size Adjustments**. When finished select **DONE**, and the game will reset to configure the new screen size setting.

## Silver Strike LIVE 7300 Video Card

### Component

**VIDEO:** Using the component adapter, connect the Display Port to the Video Component In on the rear of the television (Red-Pr, Green-Y, Blue-Pb or RGB).

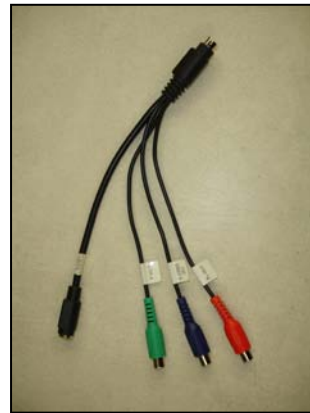
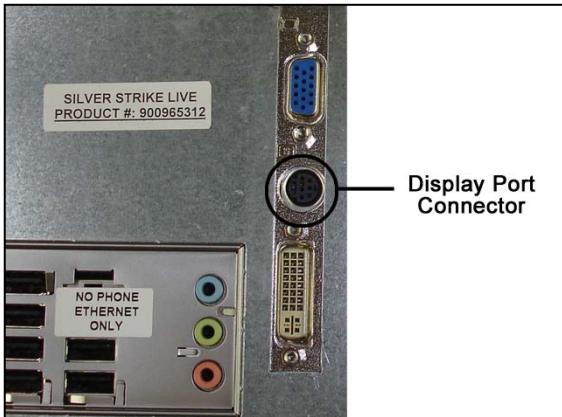

Component Adapter



Audio/Video Component In - Example

**AUDIO:** Connect the 2-wire RCA (red and white) audio cable from the RCA Audio Out on the system box to the same input of the television used for the component cables.

### DIP SWITCH SETTINGS: (Standard 720P HDTV)

Prior to power up set the DIPs as shown:

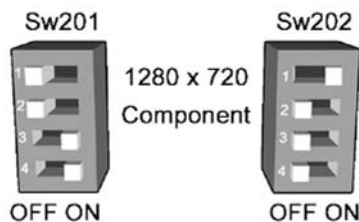

**Note:** In the event the image being displayed is overshooting *or* not extending to the perimeter of the screen, increase or decrease the image size by opening Operator Adjustables in the game, and then choosing **Main Menu** → **Troubleshooting Shortcuts** → **Screen Size Adjustments**. When finished select **DONE**, and the game will reset to configure the new screen size setting.



## VGA

**5200 Video Card (865 Motherboard)**

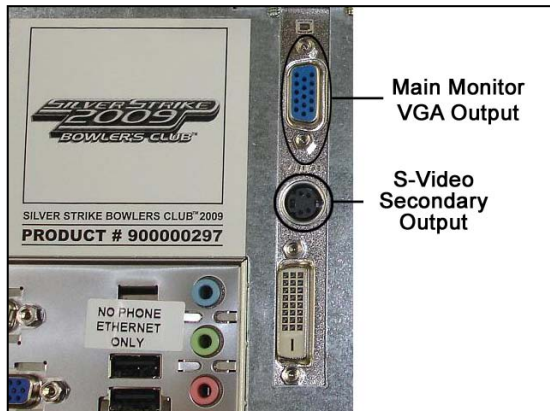

**7300 Video Card (965 Motherboard)**

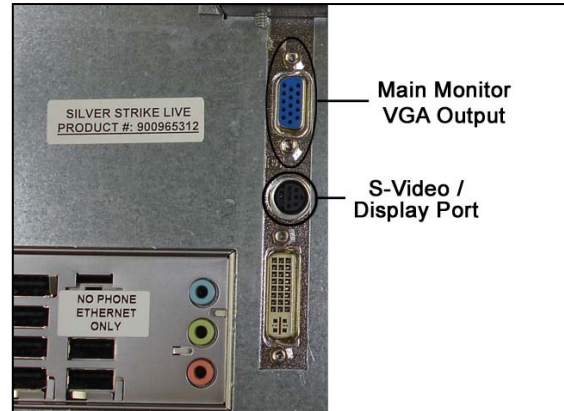

**VIDEO:** Connect the VGA cable to the upper port of the video card. Run the VGA cable to the PC input (VGA) of the television.

**S-VIDEO:** S-Video can be used if VGA is unavailable at the television input, or to display out to a secondary monitor.

**AUDIO:** Connect the 2-wire RCA (red and white) audio cable from the RCA audio out on the system box to a 1/8<sup>th</sup>-inch Stereo Y-Adapter. Connect to the television PC audio input.

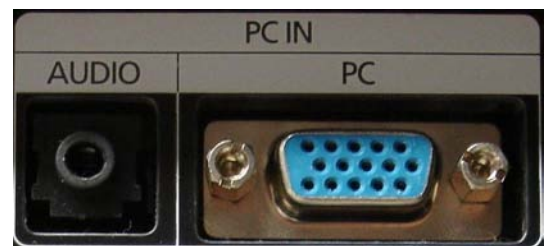

**Example of PC Input with 1/8<sup>th</sup>-inch Audio Input**

**Note:** PC Inputs on most televisions accept an 800x600 signal. *Some* models will only display a 640x480 signal and *others* will accept up through a 1280x720 signal across VGA, but not all. See television specifications for details.

### DIP SWITCH SETTINGS:

Prior to power up set the DIPs as shown:

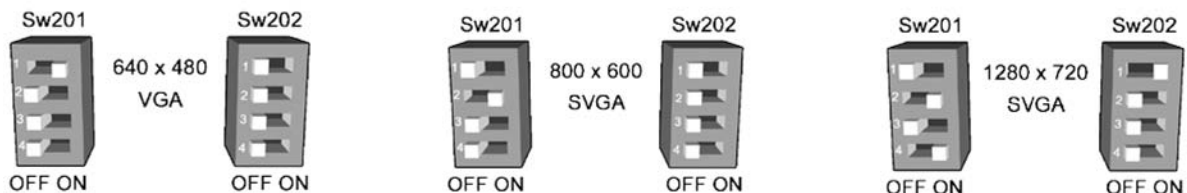

## DVI to HDMI

**5200 Video Card (865 Motherboard)**

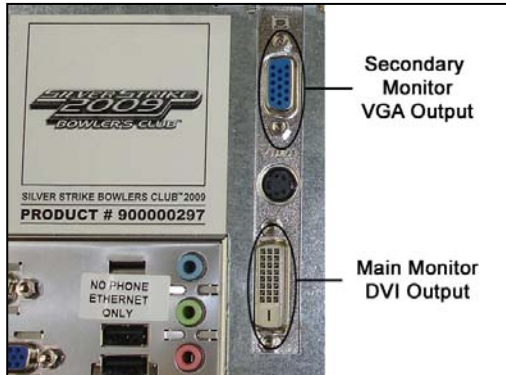

**7300 Video Card (965 Motherboard)**

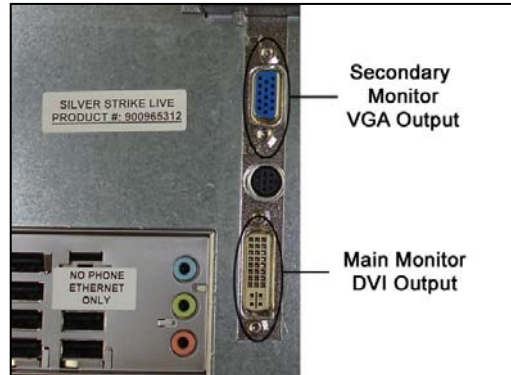

**VIDEO:** To expose the DVI Output, remove the DVI to VGA Adapter from the lower port on the video card. Connect a DVI to HDMI Cable (or DVI to HDMI Adapter w/ a HDMI Cable) to the Main Monitor DVI Output. Run the HDMI end to the desired HDMI input of the television.

**Note:** Some televisions designate which input should be used for DVI to HDMI connections.

**AUDIO:** Connect the RCA Cables to the System Box Audio Output (RCA contacts next to the Power Supply). If your television is equipped with RCA Inputs designated to a HDMI Input, you may route your RCA Cables here to output sound across the television speakers.

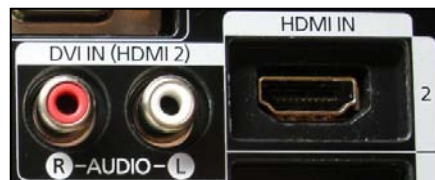

**Example of HDMI Input with RCA Inputs**

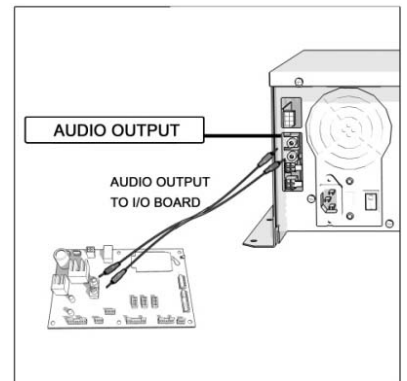

**Route to I/O Board if no HDMI Input with RCA Inputs**

If your television is NOT equipped with RCA Inputs designated to a HDMI input, route RCA Cables to the I/O Board RCA inputs for sound across the cabinet speakers. (See diagram at right.)

**DIP SWITCH SETTINGS:** (Standard 720P HDTV)

Prior to power up set the DIPs as shown:

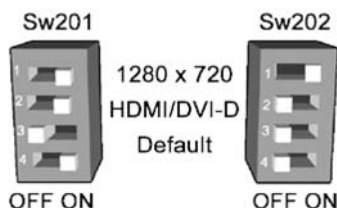



### SECONDARY MONITOR

If you plan to use Two TVs for your video outputs, follow the instructions below.

#### ABOUT THE SECONDARY MONITOR

Most Incredible Technologies games support a secondary monitor so more of your players can see the action. SS LIVE can also show the main display on the second monitor.

Incredible Technologies recommends using a 16:9 computer monitor. With SS LIVE, the second monitor requires an SVGA or VGA connection from the Nighthawk system box to the digital display of your choice. See the Sw202 DIP switch settings on page 5 to adjust the display.

#### PRIMARY VIDEO

See previous page for connecting the primary monitor using the component cable.

#### SECONDARY VIDEO

The secondary monitor requires an SVGA/VGA connection (not included) from the Nighthawk system box to the digital display. See the Sw202 DIP switch settings on a previous page for proper adjustments.

**NOTE:** If there is any difficulty viewing the secondary monitor, check General Adjustments in Operator Adjustable settings to ensure that the 2<sup>nd</sup> Monitor Mode is set for VGA.

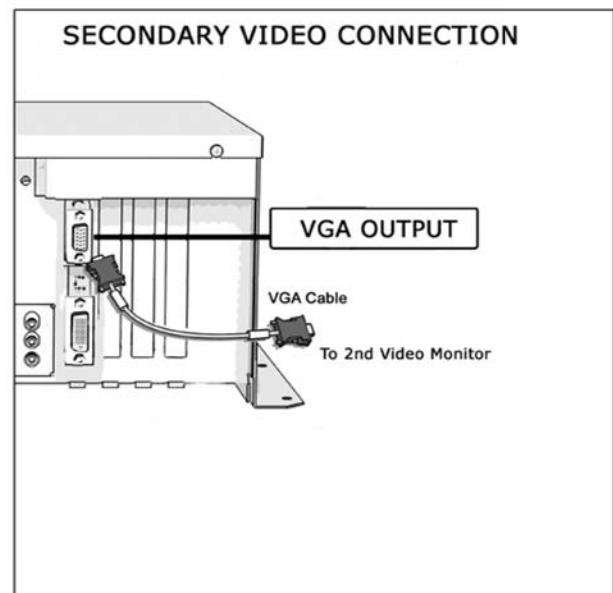





## Connection / Resolution Options for SS LIVE

**NOTE:** Silver Strike only outputs audio across the system box RCA outputs.

### **Silver Strike LIVE** 5200 & 7300 VC

- Component (7300 VC only)
  - 800x600 (4:3 aspect ratio)
  - 1280x720 (16:9 aspect ratio)
- DVI → HDMI
  - 1280x720 (16:9 aspect ratio)
- VGA
  - 640x480 (4:3 aspect ratio)
  - 800x600 (4:3 aspect ratio)
  - 1280x720 (16:9 aspect ratio)